

Global Academic Meeting, GAM 2015



17-19 September 2015, New York

PROCEEDINGS

3rd GLOBAL ACADEMIC MEETING, GAM 2015,
17-19 September, New York, USA

PROCEEDINGS

3rd GLOBAL ACADEMIC MEETING, GAM 2015,
17-19 September, New York, USA

European Scientific Institute, ESI (publishing)

Impressum

Bibliographic information published by the National and University Library "St. Kliment Ohridski" in Skopje, Macedonia; detailed bibliographic data are available in the internet at <http://www.nubsk.edu.mk/>;

CIP - 6(062)

COBISS. MK-ID 99840778

Any brand names and product names mentioned in this book are subject to trademark, brand or patent protection and trademarks or registered trademarks of their respective holders.

The use of brand names, product names, common names, trade names, product descriptions etc. even without a particular marking in this works is in no way to be construed to mean that such names may be regarded as unrestricted in respect of trademark and brand protection legislation and could thus be used by anyone.

PROCEEDINGS: 3rd Global Academic Meeting, GAM 2015, (3 2015; New York) / 3rd Global Academic Meeting, GAM 2015, 17-19 September, New York, United States of America
European Scientific Institute, ESI, 2015. (514 p.) : ilustr. ; 21 cm
Kocani, Republic of Macedonia
Email: contact@eujournal.org
Printed in Republic of Macedonia

ISBN 978-608-4642-44-2

Copyright © 2015 by the authors, ESI and licensors
All rights reserved. 2015

PROCEEDINGS

3rd GLOBAL ACADEMIC MEETING, GAM 2015,
17-19 September, New York, USA

Table Of Contents:

CARBON CAPTURE AND STORAGE(CCS) RESEARCH COLLABORATION TRENDS USING NETWORK ANALYSIS OF SCI PAPERS.....1

Ha Young Cho

Noeon Park

Gabi Cho

Young Ho Byun

POSSIBILITIES OF APPLICATION OF CRIME PREVENTION THROUGH ENVIRONMENTAL DESIGN (CPTED) IN LITHUANIAN COMMERCIAL OBJECTS.....11

Irina Matijosaitiene

Maria Dambriunas

VIBRATION POWER AND MICRO HYDROELECTRIC POWER, THE ENERGY FOR THE FUTURE.....21

Md. Nazmul Hossain

A PROPOSED RAPID METHOD FOR MEASURING AREA METHANE EMISSIONS: AN EXPLORATORY APPLICATION IN MANHATTAN, NEW YORK, USA.....31

Bryce F. Payne Jr.

Robert Ackley

Mark F. Arend

USE OF BIOMASS RESOURCES FROM FOREST AND INDUSTRIAL RELATED ACTIVITIES FOR GENERATION OF ENERGY IN THE ALUMINE AREA, PROVINCE OF NEUQUEN”.....53

Alejandro Gallino

María Inés Jatib

Horacio Repetto

Marina Bentivegna

María Sol Assusa

FREEDOM OF INFORMATION AND THE RIGHT TO ENVIRONMENTAL PROTECTION.....64

Ana Cristina Carvalho

MODELING OF HYDROLOGICAL AND ENVIRONMENTAL PROCESSES THROUGH OPENMI AND WEB SERVICES.....70

Konstantinos Kokkinos

Nicholas Samaras

Chrysi Laspidou

Athanasios Loukas

IMPACTS OF HOT IN-PLACE RECYCLING TECHNIQUES IN PAKISTAN.....83

Salahuddin Azad

INTERNATIONAL LEGAL REGULATION OF GREENHOUSE GAS EMISSIONS AND UKRAINIAN POLICY ON IMPLEMENTATION OF THE KYOTO PROTOCOL.....96

Liubov Zubkova

DEVELOPMENT AND EVALUATION OF AN ADAPTIVE NEURO FUZZY INFERENCE SYSTEM FOR THE CALCULATION OF SOIL WATER RECHARGE IN A WATERSHED.....105

Konstantinos Kokkinos

Athanasios Loukas

Nicholas Samaras

ENVIRONMENT, WATER AND TERRITORY: DIAGNOSIS AND METHODOLOGICAL ANALYSIS OF WATER RESOURCES MANAGEMENT IN A WATERSHED OF HIGHLANDS OF JALISCO MEXICO.....117

Aldo Antonio Castañeda Villanueva

Cándido González Pérez

Raymundo Velasco Nuño

“AN APPLIED RESEARCH TO SUPPLY ENERGY COMING FROM EXPLOITATION OF BIOMASS SCRAPS TO “LITTLE AND MIDDLE ENTERPRISE (LME)” (PART ONE).....128

Francesco Patania

Antonio Gagliano

Francesco Nocera

Agrifoglio Antonio

MODELED HYDROLOGIC RESPONSE UNDER CLIMATE CHANGE IMPACTS OVER THE BANKHEAD NATIONAL FOREST IN NORTHERN ALABAMA.....140

Anil Acharya

TECHNIQUES OF CCHP AS A RIGHT WAY TO APPLY THE 2ND LAW OF THERMODYNAMIC: CASE STUDY (PART ONE).....155

Francesco Patania

Antonio Gagliano

Francesco Nocera

Agrifoglio Antonio

CLOUD COMPUTING AND ITS EFFECT ON PERFORMANCE EXCELLENCE AT HIGHER EDUCATION INSTITUTIONS IN EGYPT(AN ANALYTICAL STUDY).....163

Ahmed Hussein

Omar Mohamed

BRAIN-COMPUTER INTERFACE: COMPARISON OF TWO CONTROL MODES TO DRIVE A VIRTUAL ROBOT.....177

Ron-Angevin Ricardo

Debeyre Aurélie

Marquet Yvan

Lespinet-Najib Véronique

Andre Jean Marc

WOMEN'S PERCEPTION OF THE ACTUALISATION OF THE 5TH MDG (REDUCTION OF MATERNAL MORTALITY): A STUDY OF PREGNANT WOMEN IN IMO STATE, NIGERIA.....189

Nkem Fab-Ukozor

Agwu A. Ejem

IMPACT OF LEADERSHIP STYLES AMONG HEAD NURSES ON LEVEL OF JOB SATISFACTION AMONG STAFF NURSES.....203

Ibrahim Mubarak Abdelhafiz

AlaDeen Mah'd Alloubani

Mahmmoud Klaledeh

Naif Mutari

Mohammad Musa Almkhtar

CHEMICAL COMPOSITIONS, ANTIOXIDANT CAPACITY OF TIGERNUT (Cyperus esculentus) AND POTENTIAL HEALTH BENEFITS.....217

Ogunlade, I.

Adeyemi Bilikis

A., B.Sc

Aluko Olanrewaju

G., B.Sc.

REGIONAL WATER USE PRACTICES IN THE KWAHU EAST DISTRICT OF GHANA AND THE POTENTIAL INFLUENCE ON DIARRHEAL DISEASE.....225

Deborah Lardner

Michael Passafaro

Kristin F. Gotimer

David Guernsey

Christina Padgett

Sriniketh Sundar

CRITERIA OF THE RETURN TO SPORT AFTER RECONSTRUCTION OF THE ANTERIOR CRUCIATE LIGAMENT237

Hussein Alaa Eddine

Hassan Kanso

Houssein Ziab

Hassane Kheir Eddine

Hassan Karaki

Alfred Houry

Khodor Haidar Hassan

PRIVATE HOSPITAL CHOICES OF INFERTILE PATIENTS THAT RECIEVED IVF TREATMENT: A PILOT STUDY.....246

Emrah Cengiz

Haluk Ozsari

Irfan Akyuz

Ahmet Tuzcuoglu

Haydar Hosgor

ADVANCING GENDER EQUALITY IN SIERRA LEONE'S LAND SECTOR.....265

Tegan Joseph Mosugu

CHALLENGES OF TERTIARY EDUCATION IN LIBERIA AND POSSIBLE SOLUTIONS.....273

Mory D.A Sumaworo

REFLEXIONS ON A MASSIVE OPEN ONLINE COURSE ‘ACADEMIC WRITING’.....286

Rosa May-Melendez

Rafael Ferrer-Méndez

Gina Pacheco-Balám

Alma Sánchez

GENDER IMBALANCE IN THE ACADEMIA IN NIGERIA.....294

James Adeola Olaogun

Anthony Abayomi Adebayo

Catherine Ajoke Oluyemo

SCIENCE AND TECHNOLOGY IN AFRICA FOR THE TWENTY FIRST CENTURY: PERSPECTIVES FOR CHANGE.....307

Olatunbosun Emmanuel Ogunseemi

INSTITUTIONALIZATION OF GENDER MAINSTREAMING IN NIGERIA’S TERTIARY.....314

Olabisi Idowu Aina

Ibiyinka Ogunlade

Oluwatoyin Olatundun Ilesanmi

Comfort, Afolabi

WEBQUESTS AS A METHOD OF COLLABORATIVE TEACHING.....340

Nazu Shaukenova

THE EAST AND WEST TRUST DEFICIT IN MOHSIN HAMID’S THE RELUCTANT FUNDAMENTALIST.....346

Uzma Imtiaz

ECOTRANSLATION: A JOURNEY INTO THE WILD THROUGH THE ROAD LESS TRAVELLED.....356

Guillermo Badenes

Josefina Coisson

**NETWORKS ROLE IN CONTEMPORARY SOCIAL MOVEMENTS
AN EMPIRICAL ANALYSIS OF THE ANTI-NUCLEAR
MOVEMENT OF JAPAN.....369**

Rosemary Soliman

**AN INDONESIAN PERSPECTIVE TOWARD MARITIME VISION:
IS PURSUING NATIONAL INTEREST WHILE MAINTAINING
NEUTRALITY IN THE SOUTH CHINA SEA POSSIBLE?.....381**

Masyithoh-Annisa Ramadhani

**REEVALUATING PREVIOUS CONCEPTS OF “THE
NATION”.....401**

Izolda Takács

**SYNCHRONOUS COMMUNICATION BETWEEN HIGHER
EDUCATION INSTITUTIONS AND EMPLOYERS IN THE FIELD
OF SOCIAL WORK.....418**

Beata Krahulcová

Olga Zelinkova

**IMPLEMENTING A SUSTAINABLE PURCHASING POLICY: AN
EXPLORATORY STUDY IN THE COLAS GROUP.....427**

Oihab Allal-Chérif

FASHION: MALAYSIAN MUSLIM WOMEN PERSPECTIVE.....438

Muhammad Tahir Jan

Kalthom Abdullah

ISLAMIC PENSION FUNDS PERFORMANCE IN TURKEY.....455

Basak Turan Icke

Caner Akbaba

**ONGOING SUPERVISED STAFF TRAINING MODEL : A
THEORETICAL PLATFORM FOR HIGH-ORDER THINKING
SKILLS COACHING IN A MULTI-DISCIPLINARY
ENVIRONMENT.....467**

Irit M. Nassie

**IMPACT OF BUSINESS ENVIRONMENT ON ORGANIZATION
PERFORMANCE IN NIGERIA- A STUDY OF UNION BANK OF
NIGERIA.....478**

Gloria Obiageli Eruemegbe

MARGIN SQUEEZE IN THE U.S. AND THE EU: WHY THEY DIFFER?.....495

Demetrius Yannelis

CARBON CAPTURE AND STORAGE(CCS) RESEARCH COLLABORATION TRENDS USING NETWORK ANALYSIS OF SCI PAPERS

Ha Young Cho, M.S

Noeon Park, PhD

Gabi Cho, M.S

Young Ho Byun, M.A

Korea Institute of Science and Technology
Evaluation and Planning (KISTEP), Korea

Abstract

Climate change has become one of the most important global agenda, and nations worldwide are taking actions to resolve the issue and contribute to the new climate change regime. In the case of South Korea, the new goal of reducing greenhouse gas emission to 37% below BAU(Business-As-Usual) was set. As a means to achieve this goal, the Korean government is actively investing in highly effective greenhouse reduction technologies such as solar cell, fuel cell, bioenergy, secondary battery, power IT, and CCS(Carbon Capture and Storage). This paper investigates the overall trend of CCS research by examining international CCS research collaboration characteristics through network analysis of SCI papers; collaboration network of Korea is analyzed in further detail. Such analysis helps understand the status of international research in the field of CCS, especially that of Korea.

Keywords: Carbon Capture and Storage, CCS, Network Analysis, Research Collaboration

Introduction

Over the past decade, gravity of the issue of climate change has continued to increase globally on various aspects such as science, environment, politics, and economy. (Hoegh-Guldberg, 1999; Walther et al., 2002; Watson, 2003; IPCC, 2007; Li et al., 2011) As a means to resolve the issue, countries in the COP21 climate negotiations each submitted their INDC(Intended Nationally Determined Contribution) to the UNFCCC; South Korea set the goal of greenhouse gas emission reduction to 37% below

BAU(Business-As-Usual) by 2030. In order to achieve this goal, the Korean government is actively investing in highly effective greenhouse reduction technologies; the six key technologies include solar cell, fuel cell, bioenergy, secondary battery, power IT(Information Technology), and CCS(Carbon Capture and Storage). In this study, trends in CCS research is investigated through network analysis of CCS-related SCI papers over the past 3 years. This allows us to understand the status of international R&D(Research and Development) collaboration of CCS research. Finally, through separate network analysis of SCI papers involving Korea, the state of CCS-related R&D collaboration in Korea can be examined in further detail.

Research Method

The key method in this study is Social Network Analysis(SNA), which is popularly used to map and measure the relationships and interactions among various nodes. (Yoon et al., 2012) Authors' countries were set as nodes and the links among them represent the research collaborations in publishing the papers. In addition to the visualization of the research network, measures such as centrality can be used for a quantitative and qualitative analysis.

The database of SCI papers used in this study was constructed from Web of Science provided by Thomson Reuters, an academic citation indexing and search service combined with web linking. (Cho et. al, 2013) Information such as the title, abstract, journal, publication type, authors' affiliation, country, and publication year of CCS-related SCI papers was collected. The papers used for analysis were published during the years 2012-2014; the most current annual data available was used, with 3 years being the minimum period of analysis needed to observe the trend of collaboration. Researchers and experts in the field of CCS reviewed the database to ensure the relevance of the papers and categorized them by 17 major technologies of CCS. (Table 1) Total of 9,318 papers were used for final analysis.

For network analysis of these papers, a Korean software tool NetMiner developed by Cyram was used. Analysis procedure from a previous research (Cho et. al, 2013) was followed in general. From the information collected on each paper, authors' country was selected and used for analysis; each country was set as nodes and the paper was set as links to visualize the international research collaborations. Additional network measures such betweenness centrality-a value that represents the importance of a node in bridging other nodes- was used to further describe the characteristics of the network.

Results

The number of SCI papers in the field of CCS has increased overall during the years 2012-2014. (Table 1) Research on pre-combustion CO₂ capture and post-combustion CO₂ capture was the most active; however, they showed opposite trends. The number of papers related to pre-combustion CO₂ capture was significantly higher than the others until the year 2013, but dropped rapidly in 2014. The number of papers related to post-combustion CO₂ capture increased continuously, with a rapid increase in 2014 and becoming the most actively researched field.

USA and China published the most papers, maintaining a dominant position; the number of papers published in China increased steadily while USA showed a slight decrease in 2014. (Table 2) Countries following the top runners, such as Germany, South Korea, Japan, and Spain showed similar numbers of papers. CCS research in South Korea seemed to grow rapidly in 2014, taking the place of Germany. The number of papers published in Spain and Italy decreased slightly in 2014.

Table 1. Number of SCI papers published per CCS technology (2012-2014)

CCS Technologies	Number of SCI Papers		
	2012	2013	2014
Pre-combustion CO ₂ Capture	1004	1172	240
Post-combustion CO ₂ Capture	464	647	928
Chemical Conversion	281	319	593
Direct CO ₂ Utilization	310	236	442
CO ₂ Capture - Others	162	208	258
Photo & Electrochemical Conversion	59	56	217
Oxyfuel Combustion	31	34	172
Large-scale CO ₂ Storage Facilities	71	103	111
CO ₂ Leakage Monitoring & Environmental Safety	75	112	88
Biological Conversion	50	75	87
CO ₂ Storage Injection Control & Behavior Observation	68	84	62
CO ₂ Compression & Transportation	45	53	57
CO ₂ Storage - Others	57	58	53
CO ₂ Storage Design & Injection Facilities	19	29	45
CCS Convergence Technology	7	11	14
CO ₂ Conversion & Utilization LCA	1	1	11
CO ₂ Conversion & Utilization - Others	16	16	6
Total	2720	3214	3384

Table 2. Top 10 countries for CCS related SCI paper publication (2012-2014)

Country	Number of SCI Papers			
	2012	2013	2014	Total
Peoples R China	543	734	855	2132
USA	569	696	673	1938
Germany	160	182	188	530
South Korea	146	150	230	526
Japan	154	180	183	517
Spain	150	184	169	503
England	144	165	176	485
Australia	111	161	182	454
Canada	130	150	153	433
Italy	109	136	114	359

The international CCS research collaboration network for the year 2012-2014 was a single network. (Fig. 1) Node size represents the collaboration frequency of the focal country, and link width and darkness represent the total number of collaborations-papers published- with the target country. (Cho et. al, 2013)

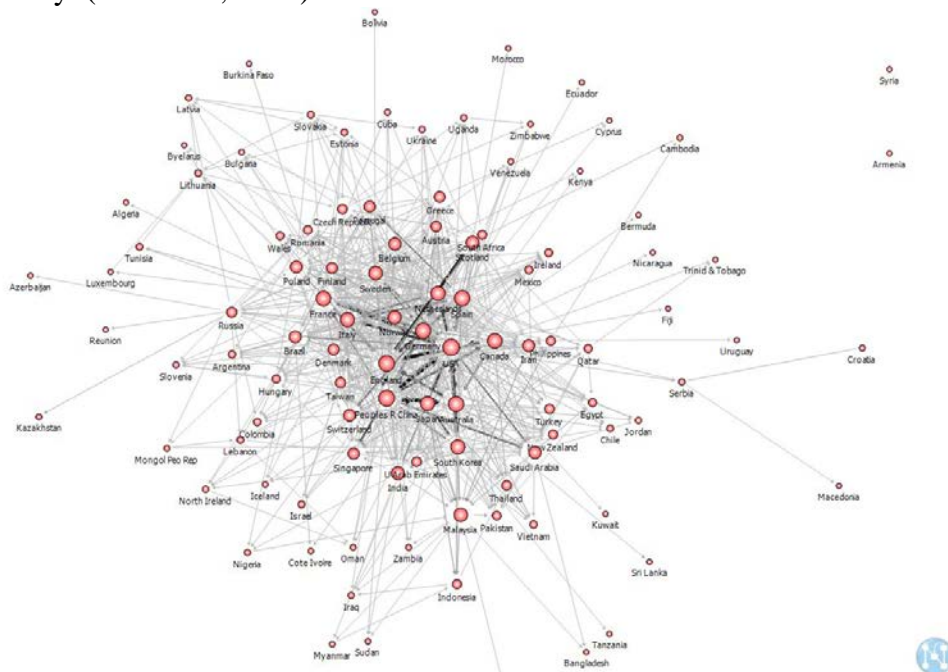

Fig. 1 International CCS research collaboration network (2012-2014)

When the network of countries with top 10 percentage collaboration was visualized separately, it could be seen that countries with high numbers of paper publication also tend to collaborate more frequently and diversely; USA and China appeared in the center of the network. (Fig. 2)

Betweenness centrality analysis also showed that USA played the most important role in connecting the other countries in the CCS research network. (Table 3) Although France wasn't one of the top 10 countries in terms of the number of papers published, it had a strong influence on the network.

South Korea collaborated diversely with various countries on CCS research, but worked intensively with a small group of countries; the link with USA appeared to be especially strong. (Fig. 3) Considering that South Korea published a relatively high number of papers, betweenness centrality was lower with a value of 0.032504 and a ranking of 13th place.

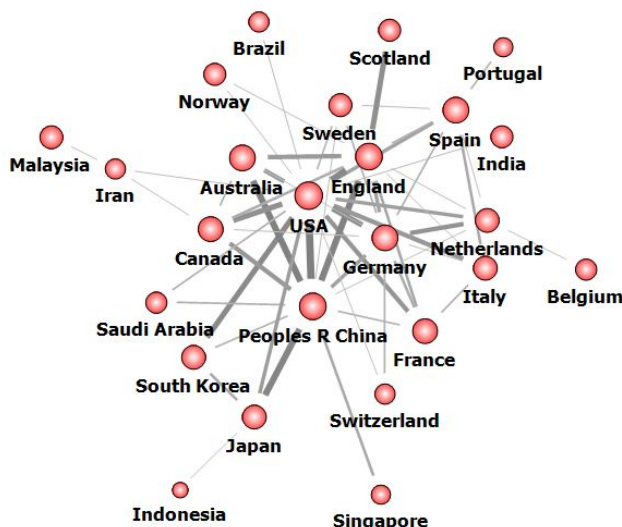

Fig. 2 International CCS research collaboration network – upper 10% collaboration (2012-2014)

Table 3. Countries with top 5 betweenness centrality in the CCS research network

Country	Betweenness Centrality (CCS)
USA	0.240171
France	0.115879
Spain	0.081405
England	0.070563
Sweden	0.051301

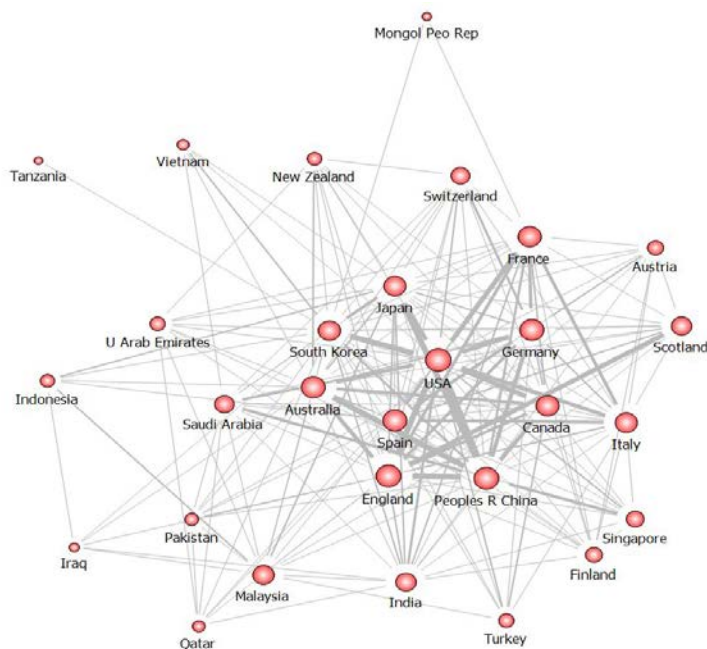

Fig. 3 International CCS research collaboration network of South Korea (2012-2014)

Networks of two most actively researched areas in CCS – pre and post combustion CO₂ capture- were both single network groups, but showed some differences. In the field of pre-combustion CO₂ capture, countries worked with various partners while links between USA and China, China and Australia, and USA and England stood out. (Fig. 4) In the field of post-combustion CO₂ capture, China and USA showed multiple strong collaborations. (Fig. 5)

Betweenness centrality analysis confirmed that USA played the most important role in connecting the other countries in the pre and post-combustion CO₂ capture research networks. (Table 4) In the field of pre-combustion CO₂ capture, England and Japan stood out as one of the key players in the network. In the field of post-combustion CO₂ capture, unlike the general CCS research network, Malaysia stood out as a key player.

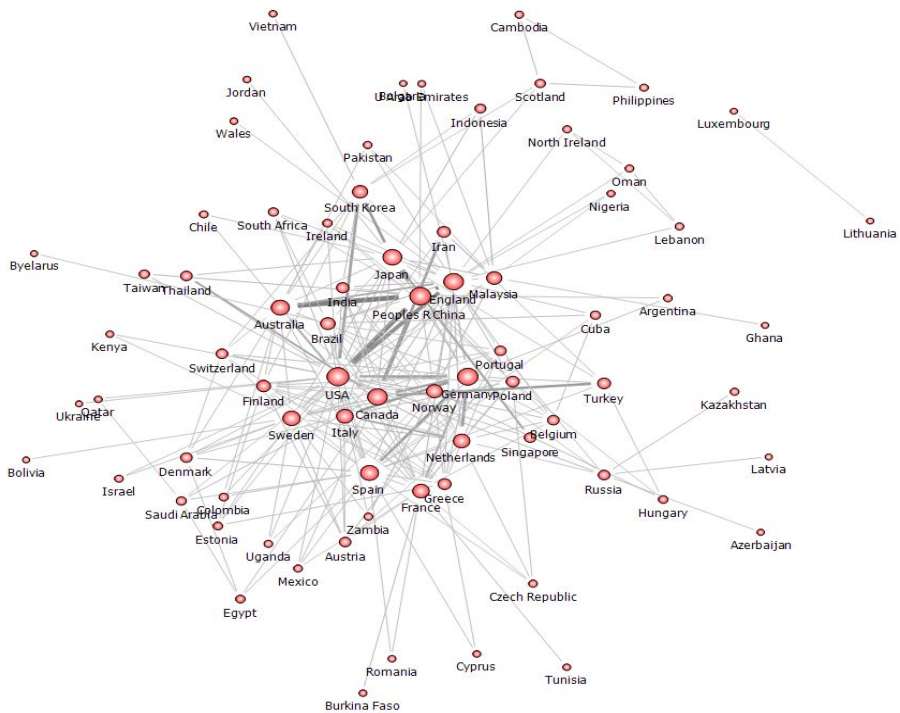

Fig. 4 International collaboration network of pre-combustion CO₂ capture research (2012-2014)

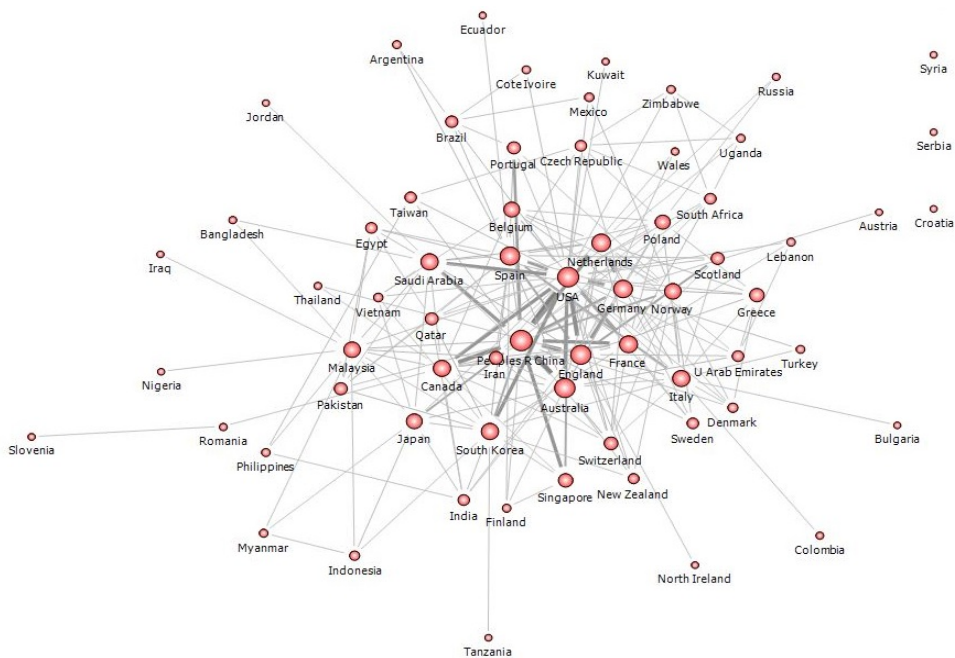

Fig. 5 International collaboration network of post-combustion CO₂ capture research (2012-2014)

Table 4. Countries with top 5 betweenness centralities in pre&post-combustion CO₂ capture research networks

Country	Betweenness Centrality (Pre-Combustion CO ₂ Capture)
USA	0.257737
England	0.161626
Japan	0.094834
Russia	0.066575
Spain	0.064000

Country	Betweenness Centrality (Post-Combustion CO ₂ Capture)
USA	0.310101
Malaysia	0.100953
Spain	0.084160
England	0.075088
Canada	0.074928

In the case of South Korea, collaboration network was more diverse in the field of post-combustion CO₂ capture (Fig. 6(b)), where the main partner was USA. South Korea showed a strong link with Japan and USA in the field of pre-combustion CO₂ capture (Fig. 6(a)). Betweenness centrality of South Korea in pre and post-combustion CO₂ capture were 0.04657(ranking 9th) and 0.058733(ranking 8th) respectively; both networks appeared slightly higher than the value in the general CCS research network.

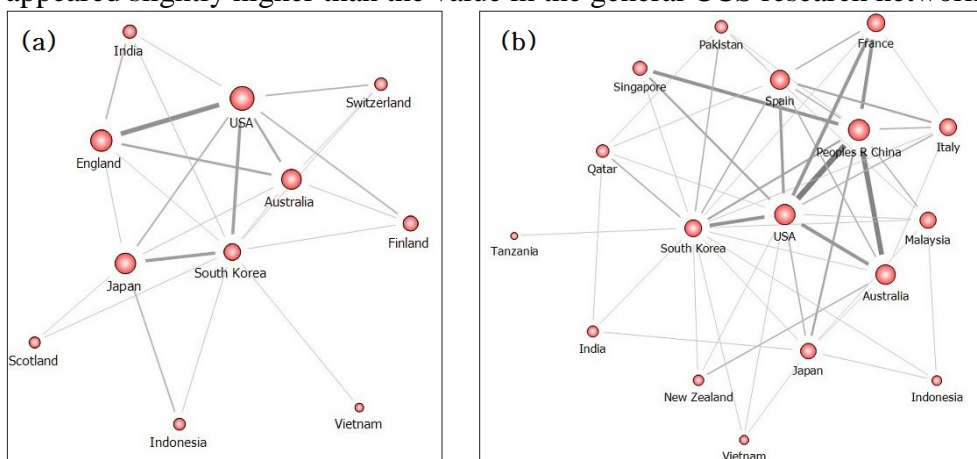
Fig. 6 International collaboration network of pre&post-combustion CO₂ capture research of South Korea (2012-2014)

Conclusion

To investigate the research trend of CCS, network analysis of CCS-related SCI papers published in 2012-2014 was conducted. The number of SCI papers published on CCS research increased steadily, with China and USA holding the lead. In terms of centrality, USA was the most influential country in the CCS research network, followed by France. South Korea tended to collaborate intensively with a small group of countries, especially USA.

Research on pre-combustion CO₂ capture and post-combustion CO₂ capture was the most active. In terms of centrality, USA was the most influential country in these networks as well. In the field of pre-combustion CO₂ capture, England and Japan also stood out as one of the key players in the network. In the field of post-combustion CO₂ capture, unlike the general CCS research network, Malaysia stood out as a key player. South Korea showed a strong link with Japan and USA in pre-combustion CO₂ capture research, while showing a more diverse network in post-combustion CO₂ capture research.

From these results, it can be suggested that diversification of CCS research network can help improve the effectiveness of CCS R&D in South Korea. Considering the quantity of papers published, collaboration with various countries could enhance the influence of CCS research conducted in South Korea.

Further analysis using additional network measures and detailed investigation on each of 17 major CCS related categories would yield a more accurate representation of CCS research trend. The interesting shift in the field of pre and post combustion CO₂ capture would also need to be explored further for a more specific and detailed explanation.

References:

- Cho, H.Y., Kim, J.H., Park, N.,(2013). Investigating Photovoltaic Research Trends Using Network Analysis of SCI Papers. Proceedings of the Multidisciplinary Academic Conference 2013
- Hoegh-Guldberg, O, (1999). Climate change, coral bleaching and the future of the world's coral reefs. *Mar. Freshwater Res.* 50, 839-866
- IPCC (2007), *Climate Change 2007:Synthesis report*. Contribution of Working Groups I, II, and III to the fourth assessment report of the intergovernmental panel on climate change. In: core writing team, pachauri, R.K., Reisinger, A., IPCC, Geneva, Switzerland, 104 pp.
- Li, J., Wang, M.H., Ho, Y.S.,(2011). Trends in research on global climate change: a science citation index expanded-based analysis. *Global Planetary Change* 77, 13-20

Walther, G.R., Post, E., Convey, P., Menzel, A., Parmesan, C., Beebee, T.J.C., Fromentin, J.M., Hoegh-Guldberg, O., Bairlein, F.,(2002). Ecological responses to recent climate change. *Nature* 416, 389-395

Watson, R.T.,(2003). Climate change: the political situation. *Science* 302, 1925-1926

Yoon, J., Kim, K. (2012) An analysis of property-function based patent networks for strategic R&D planning in fast-moving industries: The case of silicon-based thin film solar cells, *Expert Systems with Applications*, 39, 7709-7717

POSSIBILITIES OF APPLICATION OF CRIME PREVENTION THROUGH ENVIRONMENTAL DESIGN (CPTED) IN LITHUANIAN COMMERCIAL OBJECTS

Irina Matijosaitiene, PhD, Assoc. Prof.

Kaunas University of Technology, Lithuania

Maria Dambriunas, BA

Michigan University, USA

Abstract

Five commercial objects (Soviet-time, fully reconstructed and newly built) located on one of the most crime-ridden and problematic streets of Kaunas city, Lithuania, are researched according to crime prevention through environmental design (CPTED) strategies: natural surveillance, access control, territoriality, maintenance, and activity support. Theft from motor vehicle, robbery and intentional damage of property are analyzed. Research results reveal that CPTED is poorly implemented in all analyzed objects. Though, in Soviet-time commercial objects it is even harder to implement activity support strategy. Correlation analysis demonstrates significant strong relations between the analyzed crimes and some criteria from surveillance, access control, territoriality and activity support strategies. Recommendations for safety improvement in commercial objects are proposed based on CPTED strategies.

Keywords: Theft from motor vehicle, robbery, damage of property, crime prevention through environmental design (CPTED), commercial

Introduction

Crime Prevention Through Environmental Design (CPTED) supports and develops great ideas on crime prevention through urban planning and design (Jeffery, 1971; Crowe, 2013; Cozens *et al.*, 2005; Saville and Cleveland, 2008; Sutton *et al.*, 2014; Atlas, 2013; Armitage, 2013). The process of designing security into urban planning and architecture is known as CPTED, and it is based on the proposition that the appropriate design and application of the built and surrounding environment can improve the quality of life by deterring crime and reducing the fear of crime (Atlas, 2013). The

term Crime Prevention Through Environmental Design was first presented by American criminologist C. Ray Jeffery in 1971. CPTED differs from traditional security tools in urban planning and architecture. Traditional security tools mean building of fences, walls, installing of alarms, as well as police officers and guards on the streets. Whereas, CPTED focuses more on natural security strategies, such as natural surveillance, access control, territorial reinforcement, maintenance and activity support (Ekblom, 2013).

Natural surveillance strategy is closely related to “eyes on the street”. The strategy says that the more a space is observed by residents, passengers, and police (through windows, entering and exiting the building, walking or standing in open public spaces) the more secure it is. J. Jacobs (1961) was the first who developed the theory of the “eyes on the street”. She stated that the ability of residents to watch the streets and their presence on the street change criminals’ behavior, and that the lack of natural surveillance promotes crime. She also points out that the clear differentiation of private and public spaces, diversity of use and highly used streets by pedestrians will make the city safer.

Access control strategy says that it is very important to make paths, doors, entrances, exits safe, visible, and easy accessible. Proper planning of fences, lighting, signs, paths etc. is important in this case. The goal of this planning is to deter the criminals from committing a crime.

Territorial reinforcement strategy pays great attention to the differentiation of public space from private. This definition can be done by different materials for pedestrian paths or parking lots, greenery, various signs and other elements of surrounding environment and urban design.

Maintenance is the most recently added strategy to CPTED. Unmaintained territories attract criminals, as in the case of the “broken window theory” (Kelling and Wilson, 1982) one broken and unrepaired window causes more broken windows, and as a result the territory becomes unmaintained and abandoned.

Activity support strategy encourages people to observe the area through their daily activities. Thus, their presence and behaviour will discourage offenders from committing a crime.

I. Research object and methodology

The aims of this study are to investigate if crime prevention through environmental design (CPTED) strategies were applied to the design of Lithuanian commercial objects, and to identify the elements of an urban environment (according to CPTED strategies) that affect crime on commercial sites.

Research objects

Most parts of Lithuanian cities were built in the Soviet times. For our research five commercial objects on Kreves street in the city of Kaunas are selected as a case study (Fig. 1). This is chosen due to high crime rates (according to Kaunas County Police Headquarters, Kreves st. is one of the most crime-ridden and problematic areas), and the street being a typical urban tissue of post-Soviet residential areas. Kreves street is actively used by public and private transport (both local and transit), as well as residents of surrounding areas. There is a big variety of land uses along the street. The biggest part of the area is occupied with 5 and 9 storey multi-flat residential buildings with inner yards and playgrounds connecting them. There is also a variety of commercial objects (bigger supermarkets and small businesses, including kiosks), a couple of banks, kindergartens and schools (secondary and professional), and two parks along the street. The end of the street is built up with industry, storage and infrastructure objects, many of them are abandoned, though, it this part of Kreves st. is not included in our case study.



Fig. 1. Researched commercial objects on Kreves street

Kreves st. 43a is a newly built Rimi supermarket. Kreves st. 43 and 49 are Soviet-built buildings with various small-businesses inside. Kreves st. 97a is also a Soviet-time building that is run by a funeral office now. Kreves st. 97 is a fully reconstructed Soviet building with a modern IKI supermarket on one side and automobile service on the back side of the site. Crimes committed on the site (but not inside the building) are selected for the analysis. The only types of crimes committed in the research objects are as follows: theft from motor vehicle (9), robbery (4) and intentional damage of property (1). This is the reported and registered data during 2010-2011. It is worth to mention, that in Lithuania the level of latent criminality is very

high. This means that many crimes go unreported to the police, especially in instances of crimes with low damage value estimated.

Methodology

The designed research process consists of three steps: 1) site assessment according to CPTED strategies, 2) analysis of current situation on every site, 3) identification of factors of urban environment that affect crime.

Thefts from motor vehicles, robberies and intentional damages of property are analyzed according to crime rates that are simply the number of crimes committed at the particular address.

For the site assessment according to CPTED strategies the questionnaire is designed based on the analysis of literature and existing CPTED audit and site assessment checklists in different countries. The questionnaire with 82 questions in total is divided into five blocks according to CPTED strategies: 1) elements of surveillance, 2) elements of access control (and target hardening), 3) elements of territoriality (territorial reinforcement), 4) elements of image management (maintenance), 5) elements of activity support (Table 1). In the developed questionnaire, many questions are designed to assess elements of landscape (trees, bushes, other greenery) and surrounding environment (fences, gates, paths etc.), as well as lighting (glare, color of light, illumination, height of illuminator pole, if different site areas and elements are well lit etc.).

Elements of surveillance	YES	NO
No blind spots or hiding areas		
The driveway, or where you usually park your car, should be visible from either the front or back door and at least one window		
Lighting placed in such a way that it allows people to be recognized from 7,62 meters away		
Elements of access control (and target hardening)		
Entrance to the parking area is equipped with opening gates or barrier		
Dead-end spaces are blocked off with fences or gates		
Elements of territoriality (territorial reinforcement)		
Entry points into the parking area are visible and well-defined (different paving material, changes in street elevation, architectural, and landscape design, signs, gates)		
Property lines and private areas are defined with plantings, pavement treatments, short walls, or fences		
Parking spaces are clearly marked		
Elements of image management (maintenance)		
Bushes are up to 0,91 meters high		
There is no evidence of graffiti		
Exterior lighting is maintained		
Elements of activity support		
The site is vibrant and well-used		
There is a diverse range of land-uses at the site		

Table 1. Extract from the questionnaire

For the identification of relations between nominal variables (elements of urban environment from the questionnaire that can be answered as ‚Yes‘ or ‚No‘) and scale variables (crime rate) Eta-squared correlation analysis and Chi-squared test were applied. A measure of association Eta-squared ranges from 0 to 1, with 0 indicating no association between the row and column variables and values close to 1 indicating a high degree of association. Eta-squared is appropriate for a dependent variable measured on an interval scale (interval and ratio variables are combined in the scale variable in SPSS) and an independent variable with a limited number of categories (for example, categorical variables such answers ‚Yes‘ or ‚No‘). Small correlation is being observed at $\eta^2 \sim 0.02$, medium correlation is when $\eta^2 \sim 0.13$, large correlation is when $\eta^2 \sim 0.26$. The Chi-squared test is used to determine whether there is a significant relation between the 2x2 table variables.

Geographical Information Systems (GIS), as well as Statistical Package for the Social Sciences (SPSS) were used for the implementation of this research.

Results

Five commercial sites with parking areas and surrounding environment are observed on Kreves street and checked according to the developed questionnaire, spending about 30 minutes for every site. Each element was assessed as ‚Yes‘ or ‚No‘, with the meaning of ‚Yes‘ as the element meets CPTED criterion, and ‚No‘ as does not meet. The research results demonstrate that the sites of the commercial objects (no matter if the object is a new built, fully renovated or Soviet-times built) are not designed to meet CPTED strategies at all. On different commercial sites the percent of elements meeting CPTED differs: for the elements of surveillance it is 30.43-69.57%, for the elements of access control it is 33.33-50.0%, for the elements of territoriality (territorial reinforcement) it is 30.77-71.43%, for the elements of image management (maintenance) it is 10.0-75.0%, for the elements of activity support it is 0-100%.

Kreves st. 43 object meets CPTED principles for 52% in total, having the weakest sides in surveillance and access control, and the strongest in activity support (Table 2).

Kreves st. 43a object meets CPTED principles for only 45.83% in total that is a shocking result considering that the building is new and the site looks like a well maintained at day time. The weakest side of this object is surveillance, and the strongest is activity support (Table 2).

Kreves st. 49 object meets CPTED principles for 56% in total, having the weakest side in maintenance, and the strongest in territoriality (Table 2).

Kreves st. 97 object meets CPTED principles for 52.78% in total, having the weakest side in territoriality, and the strongest in activity support (Table 2).

Kreves st. 97a object meets CPTED principles for 26.67% in total, having the weakest side in activity support, and the strongest in territoriality (Table 2).

	Surveillance	Access control	Territoriality	Maintenance	Activity support
Kreves st. 43	33.33	33.33	57.14	75	100
Kreves st. 43a	30.43	46.67	30.77	66.67	100
Kreves st. 49	69.57	50	71.43	35	66.6
Kreves st. 97	59.09	46.67	46.15	50	100
Kreves st. 97a	34.78	33.33	46.15	10	0

Table 2. Commercial objects meet CPTED strategies, %

The access control (42% of observed criteria meet CPTED) and territoriality (41.1% of observed criteria meet CPTED) of observed commercial sites are the biggest issues on Kreves street (as well as on many others in Lithuania). In the most of observed cases the private property is not defined and entrance/exit points and paths to and from the site are neither controlled nor secured. The situation concerning activity support (73.32% of observed criteria meet CPTED) looks much better. In most cases, commercial objects offer a variety of activities for customers. Additionally, the sites are generally vibrant and well used.

Thefts from motor vehicles

According to the correlation analysis (Eta-squared is calculated and Chi-squared test is applied) results (Table 3) there are relations between thefts from motor vehicles and three criteria according to three CPTED strategies:

- Natural surveillance strategy – the presence of white light color illuminating the parking area is related to thefts from vehicles ($\eta^2=0.890$, $p=0.016<0.05$). According to CPTED practice in different countries, white-colored, bright light is the best solution for illumination of parking areas (Hushen, 2014).
- Territoriality strategy – the usage of signage such as ‘Private Property’ or ‘No Trespassing’ or ‘Hours of Usage’, and ‘No Vehicle Traffic’ is related to thefts from vehicles ($\eta^2=0.890$, $p=0.016<0.05$). The signage brings order into the site aesthetics, as well as controlling pedestrian and vehicle routes.
- Activity support strategy – the criterion ‘The site is vibrant and well-used’ correlates with thefts from vehicles ($\eta^2=0.890$, $p=0.016<0.05$). A vibrant and well used site generates activity, attracts more users and

observers of the site. The more ‘eyes on the street’ the area has, the safer it is.

Robbery and Intentional damage of property

According to the correlation analysis (Eta-squared is calculated and Chi-squared test is applied) results (Table 3) the same significant relations are observed for robberies and urban criteria, and for damage of property and urban criteria. Both crimes correlate with two criteria according to two CPTED strategies:

- Territoriality strategy – the visibility and good definition of entry points into the site are related to robbery and damage of property (both $\chi^2=5.000$, $p=0.025<0.05$). According to CPTED, it is important to clearly define the entries/exits to and from the site. Hereby, the routes of pedestrians and vehicles are directed to the proper areas within the site and in the right directions.
- Access control strategy – the separation of visitors parking from employees is related to robbery and damage of property (both $\chi^2=5.000$, $p=0.025<0.05$). The separation of different zones within the site is important for a better control of pedestrian and vehicles routes, as well as for the easy identification of potential criminals on site.

		Theft from motor vehicle	Robbery	Intentional damage of property
Surveillance	White color light is installed for parking area	$\eta^2=0.890$ $p=0.016$		
Territoriality	Entry points into the site are visible and well-defined (different paving material, changes in street elevation, architectural, and landscape design, signs, gates)		$\chi^2=5.000$ $p=0.025$	$\chi^2=5.000$ $p=0.025$
	Signage such as Private Property—No Trespassing, Hours of Usage, and No Vehicle Traffic is used on the site	$\eta^2=0.890$ $p=0.016$		
Access control	Visitors parking separated from employees		$\chi^2=5.000$ $p=0.025$	$\chi^2=5.000$ $p=0.025$
Activity support	The site is vibrant and well-used	$\eta^2=0.890$ $p=0.016$		

Table 3. Relations between crimes and factors of urban environment

Conclusion

Comparison of Soviet-time, fully reconstructed and newly built commercial objects reveals that in Soviet-time commercial objects it is

harder to implement activity support, though it is possible and requires more effort. In many cases, inner spaces of the building have to be transformed and site areas have to be re-located. This notwithstanding, Kreves st. 43 is a good example of re-use of the Soviet building and site for the contemporary needs. Regarding surveillance, territoriality, access control and maintenance CPTED strategies, no significant difference is observed between all three types of objects.

Comparing research results according to all five CPTED strategies allows us to identify the strengths and weaknesses of commercial objects. Activity support is the strongest side (Soviet-time, fully reconstructed and newly built commercial objects fulfil the requirement of this strategy for 73.32%). Most commercial sites are vibrant and well used, there is a diverse range of land-uses at the sites, and the objects have restaurants / cafes / cinemas / play areas to attract people.

According to the correlation analysis results, significant and very strong relations are observed for white color lighting at parking areas and theft from motor vehicle ($\eta^2=0.890$, $p=0.016$), visibility and good definition of entry points into the site and robbery as well damage of property (both $\chi^2=5.000$, $p=0.025$), signage on the site and theft from motor vehicle ($\eta^2=0.890$, $p=0.016$), separation of visitors parking from employees and robbery as well as damage of property (both $\chi^2=5.000$, $p=0.025$), vibrancy and good usage of site and theft from motor vehicle ($\eta^2=0.890$, $p=0.016$). Based on the correlation analysis results and site assessment data, recommendations for safety improvement according to CPTED strategies are provided:

- 1) Territoriality. There still is much to be done to improve elements of territoriality (as only 41.1% of observed criteria meet territoriality requirements). There should be signs to locate where you are. No confusing zones/levels should be on the site. The street address must be clearly visible from the street with numbers a minimum of 12.7 cm high and made of non-reflective material. Parking areas should be clearly marked and separated from pedestrian walkways. Entry points into the parking area should be visible and well-defined (different paving material, changes in street elevation, architectural, and landscape design, signs, gates). Property lines and private areas must be defined with plants, pavement treatments, short walls, or fences. There should be a signage used on the site such as Private Property—No Trespassing, Hours of Usage, and No Vehicle Traffic. Businesses should be identified by wall signs for those parking in the rear.
- 2) Access control is also a weak side of commercial objects in Lithuania. Only 42% of observed criteria meet access control requirements. There should be no pathways that lead to unpredictable places. Visitors parking must be separated from employee's parking. Pedestrian paths must

be separated from vehicles. Landscaping should be used to divide the parking areas into smaller lots (applies for larger parking lots). Cut-through or high-speed traffic must be discouraged in this space. Dead-end spaces should be blocked off with fences or gates. There should be a security / police present at the site.

3) Surveillance. 45.44% of observed criteria meet natural surveillance requirements. The main rule of good natural surveillance is that a person can be seen or heard everywhere and always. There should be no blind spots or hiding areas on the site, as well as no places where offenders could easily hide and conceal themselves. Loading areas and landscaping should not create hiding places. There should be clear visibility maintained from inside the business to the street, sidewalk and parking areas. Window signs must not cover more than 10% of window space. Angled or perpendicular parking in front of stores should be used rather than parallel to allow greater visibility between cars. The street address numbers, parking lots, footpaths, exterior, access to the building, walls, corners, closest surroundings should be clearly lighted at night. White color has to be installed for parking lighting. Lighting should not glare into the eyes, and it should be placed in such a way that it allows people to be recognized from 7.62 meters away. Pedestrian scale street lighting should be used in high pedestrian traffic areas to help people recognize potential threats at night. There should be no blind walls, or public art can be used for blind walls to decrease crime.

4) Maintenance. 47.33% of observed criteria meet maintenance requirements. To reduce crime, the aesthetics of the site has to be attractive to people. The site and closest surroundings have to be well-maintained and cared for. There should be no empty buildings or spaces, no old, abandoned automobiles or other vehicles stored on the site (including inappropriate outdoor storage). There should be no presence of drunkenness or nuisance, no evidence of rubbish, graffiti or vandalism. All the structures should be painted and in a condition of good repair. Landscaping should be tidy and in good repair. Weeds must be abated, bushes must be up to 0.91 meters high, trees must be pruned up to 2.13 meters from the ground. Trees and shrubs should be pruned back from windows, doors, and walkways. Exterior lighting has to be maintained. Parking areas have to be of high standard without pot-holes or trash. No faded posters, broken signs, and other displays that are beyond their useful lives.

Acknowledgement:

Authors are grateful to LISS Program in the Lithuanian-American Community.

References:

- Armitage, Rachel. Crime Prevention through Housing Design, 2013, Hampshire, Palgrave Macmillan.
- Atlas, I. Randall. 21st century security and CPTED. Designing for critical infrastructure protection and crime prevention. Second edition, 2013, Boca Raton & Fort Lauderdale, CRC Press and Taylor and Francis Group.
- Cozens, M. Paul, Saville, Greg, Hillier, David. "CPTED: a review and modern bibliography". Property management 23(5) (2005): 328 – 356.
- Crowe, D. Timothy. Crime prevention through environmental design, 2013, Waltham, Butterworth-Heinemann.
- Eklom, Paul. „Redesigning the language and concepts of crime prevention through environmental design“. Presentation presented at the 6th Ajman International Urban Planning Conference: City and Security, in March 2013, Ajman, United Arab Emirates. Available at: <https://reconstructcpted.files.wordpress.com>
- Hushen, Arthur. Advanced Crime Prevention Through Environmental Design, CPTED Professional Designation Qualifying Course, 2014, Evansville.
- Jacobs, Jane. The death and life of great American cities, 1961, New York, Random House.
- Jeffrey, C. Ray. Crime Prevention through Environmental Design, 1971, Beverly Hills, SAGE Publications.
- Kelling, L. George, Wilson, Q. James. „Broken windows“. Atlantic Monthly 249(3) (1982): 29–38.
- Saville, Greg, Cleveland, Gerry. Second-generation CPTED. The rise and fall of opportunity theory. In: Atlas, I. Randall. 21st century security and CPTED, 2008, Atlanta, CRC Press, Atlanta, 91-105.
- Sutton, Adam, Cherney, Adrian, White, Rob. Crime Prevention: Principles, Perspectives and Practices, 2014, Cambridge, Cambridge University Press.

VIBRATION POWER AND MICRO HYDROELECTRIC POWER, THE ENERGY FOR THE FUTURE

Md. Nazmul Hossain

Engineering Business & Enterprise Management Department
Engineering Faculty
Peoples' Friendship University of Russia, Moscow, Russia

Abstract

Energy is the paramount significant component for economic, educational, science & technological development for all of the various countries in the world. It is an integral part of every sphere of modern life and indispensable for almost all of the economic development activities ranging from farm irrigation to manufacturing of goods and heavy industrial activities. But the world today is confronted with two interrelated challenges closely linked with energy; these are global unusual temperature rising and vicious cycle of poverty. Due to incremental consumption of traditional energy, earth atmospheric greenhouse gases (GHG) are rising rapidly, resulting global warming, global climate changes & ecological catastrophes. This is concern with the other challenge that 1.3 billion of the world's populations, most of them are impoverished and live in rural areas in Africa and Asia, still out of the electricity supply facilities, causing economic downturn, poverty, illiteracy, unemployment, crimes and social depression. In these very conditions, changing patterns of energy, which are carbon neutral or carbon negative, reliable and affordable, only can save the world from upcoming dangers. Together with other sources of green energy our newly invented carbon neutral "Vibration Power"& "Micro Hydroelectric Power" could be a viable alternative to save the green planet from upcoming challenges.

Keywords: Fossil fuel, Global warming, Alternative sources of energy

Introduction

The continuing interest to alternative sources of energy is increasing gradually as the world today is very much concern about rising level of earth atmospheric greenhouse gases (GHG), global climate changes and growing energy demand in short order. Global warming, the increase in the

temperature of the earth's near-surface air, is the greatest challenge the world is confronting with and world grave concern for earth's all living creations. It will affect hydrology and biology of earth-everything including economy, eco-system and substances.

This is concern with the other factor that 1.3 billion of the world's total population still out of the electricity supply facilities. Non-accessibility to energy or huge shortage of energy supply in developing countries, mostly in South-East Asian and Sub-Sahara African countries, hindering financial growth, investment opportunities and employment creation and increasing socio-economic depression, poverty & illiteracy rate. The latter undermines and limits their capabilities and their opportunities to secure employments aftermath prolonging and confinement of the poverty circle.

In these circumstances, together with other sources of green energies, our newly invented carbon neutral "Vibration Power" & "Micro Hydroelectric Power" could be viable alternatives to save the green planet.

Energy & Evolution

Energy is one of the most crucial components for economic, educational, science & technological development and center for all of the development activities. For sustainable development and growth energy is generally and electricity is particularly crucial.

Energy efficiency and effective use of energy are the key components for sustainable development for all countries and all people. To alleviate the poverty & illiteracy, promote human welfare and innovation, foster innovative culture and environment in society and promote living standard, energy is an integral part [Chaurey & Kandpal 2010a].

Virtually all forms of economic activities, whether in urban, peri-urban or in rural areas, rely on energy. Without meeting the demand of reliable and affordable energy, countries will not be able to reach the Millennium development goal [Hong & Abe 2012; Narula et al., 2012].

In Johannesburg, South Africa, in 2002, at the World Summit for Sustainable Development (WSSD), leaders from around the world emphasis the acute role of energy on alleviating poverty and promoting sustainable development.

Electricity, the most useful form of energy, can extend the working hours and days, increase productivity, improve safety and working condition and draw customer's attention.

Moreover, electricity accessibility can transform commercial activities from manual labor to mechanization & automation forms and promotes quality [Lee et al.2008].

Economic theory suggests that when energy accessibility plays role to minimize the cost of products for companies, companies react with some

combination of: multiply productivity & employment, minimize the cost of products & services and investment in other financial activities. Lower input cost might also stimulate the extension of existing firms together with the emergence of new one.

On the contrary, industrial growth is hindered, cost of products & services is intensified and economic growth and employment creation are limited if energy service is not highly reliable & of sufficient quality.

But it is a matter of fact that the availability of energy for industries & commerce is not enough alone. If energy service is not highly reliable, affordable, green & of sufficient quality, the cost of industry of energy outages & the need for investment in backup systems could be substantial and limit economic growth and higher ecological damages.

Growing Demand of Energy Worldwide

Due to acute role of energy in every development activities, the world today is consuming massive conventional energy and the demand is growing in short order. According to BP's Energy Outlook 2035, global energy demand continues to grow further beyond 2030 to 2035. The consumption is expected to soar up by 41% in between 2012 and 2035. According to International Energy Outlook (IEO) Reference case, world energy consumption will enhance to 630 quadrillion Btu in 2020 and 820 quadrillion Btu in 2040 from 560 quadrillion Btu in 2014 (524 in 2010).

The World Energy Outlook (WEO) 2013 projected that by 2050 the world would have to generate enough electricity for an additional 3.3 billion people as 2 billion will be multiplied between 2013 & 2050. The Exxon Mobil's outlook for Energy 2013 projected that between 2013 & 2040, global chemical energy demand will rise by 55% is an account for 35% of growth in industrial sector. The International Energy Outlook 2013 projected that fossil fuel, including oil, natural gas and coal, will supply 80% of the global energy through 2040.

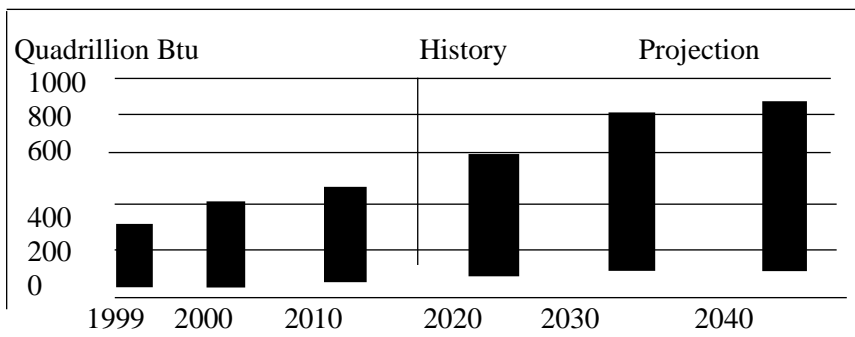

Figure 1: shows the world total energy consumption, 1990-2040 [source: IEO]

Massive Consumption of Energy & Environmental Impacts

The aftermaths of massive consumption of conventional energy would be excessive global warming & global climate changes. Global energy-related CO₂ emission will become worse than expected. According to International Energy outlook 2013 reference case, global CO₂ emission from fuel combustion continue to grow unabated, from 31.2bmt in 2010 to 45.5bmt in 2040, living the world on the track for a long-term average global temperature increase of 3.6°C or more. Scientists of National Oceanic & Atmospheric Administration said that during the 21st century the earth could warm by an additional 7.2°F if we fail to reduce greenhouse gases emission from burning fossil fuel. Fatih Birol, the chief economist of the International Energy Agency, said that despite the global agreement to stay below 2°C, the world is on the track that, without action, leads to an increase of 4°C or more by 2050.

The impacts of such an unusual global warming & global climate changes would be extremely devastating for the earth's all living beings. It will affect hydrology and biology of earth, everything including economy, ecosystem and the substances. This phenomenon (incremental temperature rising) will be causes of unusual acceleration of ecological catastrophes, such as acid precipitation, stratospheric ozone depletion, rising sea level, increasing occurrences of several weather events, more frequent of wildfire & drought, food shortage, changing patterns of diseases, severe water shortage, the loss of tropical forests and many species.

Energy Non-accessibility & Socio-economic Depression

This is another factor to be concern that 1.3 million people around the world, most of them are impoverished and live in developing African and Asian countries, still out of the electricity supply facilities. Moreover, a surprising quantity of 2.5 billion people that is around 43% of the total world population still relies on biomass. The number is reported to be multiplied to 2.6 billion by 2016 and to 2.7 billion by 2030.

The non-accessibility or insufficient supply of reliable, affordable and modern forms of energy is being causes of high rate of unemployment, crimes and socio-economic depression as well as unexpected acceleration of deforestation, household air pollution & global climate changes through greenhouse gases emission and atmospheric bromine in the form of methyl bromine lead to the chemical destruction of ozone in the stratosphere.

Alternative Renewable Sources of Energy for Safety, Prosperity and Diversity

Energy is the paramount significant component for economic, education, science & technological development but massive consumption of

traditional energy has been cause of earth atmospheric greenhouse emission, global warming and global climate changes. On the contrary, non-accessibility or insufficient supply to modern energy has been cause of mass poverty, unemployment and illiteracy in developing Asian and African countries. In these complex conditions, green renewable sources of energy could be an integral part of solution.

A study conducted by Bangladesh Climate Change Observer reported that Alternative Renewable Sources of Energy can play an intensive role to accomplish two interrelated challenges the world is currently confronted with-rapidly growing global temperature and growing demand of energy [CCOB-2010].

It has been reported that in many developing countries, renewable sources of energy (RES) projects can directly contribute to economic growth and poverty alleviation by providing energy needs to create businesses & employments.

In today's world, People are moving from rural areas to urban areas either in search for better employments, better income, better living standard or for better education. In 2014, approximately 3 billion people that are nearly about half of the global population lived in urban areas. This figure is expected to be expanded to about 75% of the world total population by the year 2025, with the most rapid changes happening in the developing world. The trend is on one hand increasing the slums in the cities, polluting the city environment, accelerating the poverty and crime rate and on the other hand hindering the rural development. Easy accessible, reliable, affordable and green sources of off grid energy in rural areas, where transmission & distribution of grid energy generated by fossil fuels is difficult, only can change the circumstance through enhancing productivity and income generation activities, better communication facilities, better education and better infrastructure [Energy for Development p, 3].

Education is widely recognized as one the most essential components for poverty reduction, according to current discourses of development studies.

But hardcore poor households send their children to work to earn money to support their poor families. Sometime children are dropped out of school to work due to school expenditure and households insolvency; most of the cases they work for three meals for a day. Such low level attainment of education causes a lack of employment opportunities for poor households.

In developing countries, women and children are mainly responsible for drudgery such as collecting fuel wood and fetching water and they spend more than an hour per day on average for this. Energy accessibility reduces this drudgery for women to involve in financially important sectors and

allow children to expand their opportunities for school attendance and other educational activities.

Easy accessible renewable sources of energy can increase the income generation activities and employment and bring disposable income of poor households to bring socio-economic sustainability. Due to these factors the number of school going children is increased and school dropout rate is reduced [IEA 2007, UNDP 2004].

**Vibration Power (Proposed)
Generation of Electricity**

When rotor of an electric motor, a tight coil of copper wire wrapped around an iron core, rotates at high speed between the poles inside a powerful, permanent magnet, mechanical energy turn into electric energy. When electricity is fed into the copper coil, it becomes a temporary, electrically powered magnet, in other words, an electromagnet, and generates a magnetic field all around it. This temporary magnetic field pushes against the magnetic field that the permanent magnet creates and forces the coil to rotate. The magnet field is called exciter and the pole is called stator.

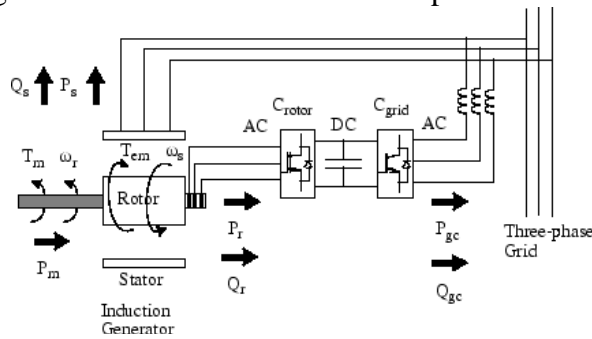

Figure 2: an ideal power generator

There are numbers of procedures existences to spin the motor to generate electricity, such as wind power, water stream, ocean tide, hot wave etc.

Over the vibration (power) technology, vibration of roads, created by velocity and pressure of vehicles run through the roads would be used to spin the motor of a specially designed generator to generate electricity.

Size & Shape of the Generator

The generator will be consists of a 3.5"*3.5"*0.5" diameter magnetic field, 2.7" diameter rotor and 2.5" diameter motor and will be fixed in a round shaped steel enclosure. Unlike the traditional square shaped round generator it would be round shaped generator to get the maximum output.

Materials

Magnet: Neodymium n-50

Wire: copper wire ($R=1.7 \times 10^{-8} \Omega \text{ m}$)

Others: Screws bring boll, steel enclosure etc.

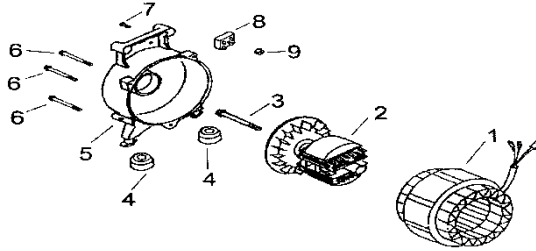

Figure 3: shows the equipment of generator

Design of Generator

To generate 5kw/c electricity other functions will be following, according to the faraday's law:

Number of poles: $n = 2 * 60 * f / (rpm) = 2 * 60 * 10 / 300 = 4$ [where, f =frequency, rpm =rotation/ minute]

Tones of wire of motor $N=11$ tons/pole

$P=5kw$

$N=4$

$D=2mm$

$N(dt)=11kv$

$I=2.5/11 Amp$

$I=V/R$

$R=PI/A$

$P = I^2 R = P = VI$

$V=11kv$

$N1/N2=I1/I2$

$I=P/V=1.25/11 Amp$

$\Phi=1.25kw/N$ (where $\Phi=I$)

$N=1.25/1.25/11=11$ tons], [Where, D =diameter, l =length, R =resistance, p =resistivity, N =number of pole, Φ =magnetic flux, t =frequency, P =power, V =voltage]

To get the efficiency,

Required frequency=10Hz

Speed=5mm/c

Installation

The generator, inside a 3.7 square inch iron frame, will be installed inside a 3.7 square inch hole under a 4" high speed breaker of busy road. A thin iron rod with highly flexible spring on top of it, like an antenna, would

be attached with the motor. When vehicles passed through the speed breaker, vibration is created. By the vibration spring is fluctuate and motor spin to generated electricity. Speed breaker is a perfect place to get the maximum vibration through the velocity and pressure of vehicles.

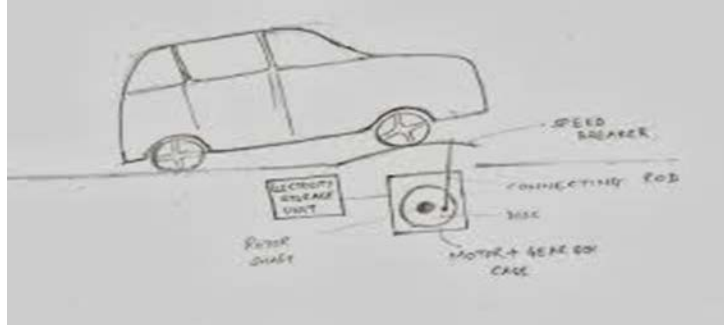

Figure 4: shows the functions and installation of vibration power generator

Amount of electricity

In pick hours, between the time 8am and 8pm, when roads are with heavy vehicles, full capacity will be got but the rest of the hours the efficiency will be almost half.

So, the amount of electricity would be

$$5kw * 60 * 60 = 18 MW/h \text{ (pick hours)}$$

$$5kw * 60 * 60 * 50\% = 9MW/h \text{ (non-pick hours)}$$

$$\text{Daily generation} = 324 MW \text{ electricity}$$

5 generators can be installed in 3 meters wide busy road and then daily generation of electricity would be 1620MW.

Generated electricity will be transmitted through transmitter and can be distributed to remote rural areas using national grid.

Micro-hydroelectric power

This is the other factor that for householder purposes, for example to light the lamp, to run the electric fan and to operate other households' substances, we use electricity. We can generate the electricity that we use every day by micro hydroelectric power at home.

Over the Micro-hydroelectric power technology waste water of basins passed through the basin's tunnel is used to turn the turbine to generate electricity.

Micro hydro-electric power turbine

Micro hydro-electric power turbine consists of two parts.

These are: 1) generator and 2) turbine.

The generator module will be 75"*75"*20" by the size to generate up to 35 watt/c of sustainable output. Turbine will be 1"*1" spoons shaped

blades made up of sustainable light plastic. The number of blades of the turbine will be ten to get the maximum output.

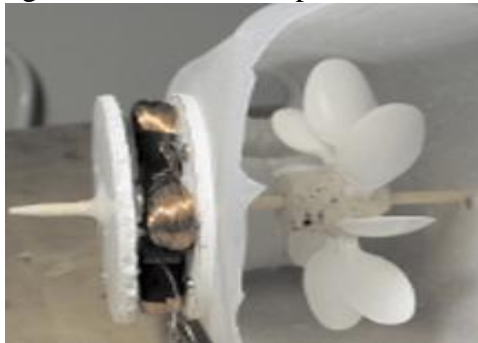

Figure 5: shows the image for a micro hydroelectric power turbine

Installation

The generator will be attested out surface of a tunnel of a basin and the turbine will be set up inside the tunnel of a basins. When waste water falls on the basins and passed through the tunnel where turbine is installed, the turbine will be turning and electricity will be generated.

The technology is highly effective in mosques, in restaurant and supermarket where water is used heavily almost around the day.

Amount of electricity

- 5wat/c
- $5\text{wat} \times 60 \times 60 = 18\text{kw/h}$

Worldwide implementation of these technologies will meet the rapidly growing energy demand and minimize the energy related greenhouse gases emission in the earth atmosphere.

Conclusion

Carbon neutral or carbon negative Alternative Renewable Sources of Energy is the demand of time when energy is indispensible for economic, educational, science and technological development but massive consumption of conventional energy is being causes of global warming, global climate changes and environmental damage and at the same time non-accessibility or insufficient supply of modern energy is being causes of massive economic downturn, poverty, illiteracy, unemployment, crimes and social depression in developing countries. Alternative renewable sources of energy only can save the world from the upcoming challenges the world going to confronting with the rising global temperature, rapidly growing energy demand and vicious cycle of poverty poverty. Together with other sources of green energy our newly invented "Vibration Power" and "Micro

Hydroelectric Power" will bring a potential breakthrough. Worldwide appliance of these technologies can save the green planet from the upcoming danger.

References:

Michael L.Mc Kinney, Robert M. Schoel, Logan Yonavjak-Environmental Science: System and Solution-2012

Moeller, D.W(2005), Environmental Health. Cambridge, MA: Harvard University Press

Rogers W.O, Okot-Uma, Georges Kosse, Yvonne Gotlop Bogatsu, Kwesi Parkon & Otlogetswe Totolo-Pollution Control & Waste Management in Development Countries

SWEEP "country profile on solid waste management situation" The Regional Solid Waste Exchange Information & Experience network in Mashreg & Maghreb Countries 2010

How the World Should Invest in Energy Efficiency, July 2008, Mckinsey Global Institute, International Panel of Climate Change (IPCC)-Climate Change Statistic

World Energy Outlook 2013, Nov. 2013, International Energy Agency (IEA) Energy Technology Perspective, June 2008, International Energy Agency (IEA)

RIA Novesti 27.08.2014

Energy For Future Presidents by Richard A. Mullar, published as a Norton paperback 2009

Krishna M.1995. "Manufacturing Energy Use in India: A Decomposition Analysis." Asian Journal of Energy and Development 1 (3): 223-47.

CCOB (climate change observer of Bangladesh). 2010. Regional climate outlook: Dhaka: CCOB-published 2010

A PROPOSED RAPID METHOD FOR MEASURING AREA METHANE EMISSIONS: AN EXPLORATORY APPLICATION IN MANHATTAN, NEW YORK, USA

Bryce F. Payne Jr., Gas Safety Inc., USA
Center for Energy, Environment and Sustainability,
Wake Forest University, USA

Robert Ackley, Gas Safety Inc., USA

Mark F. Arend,

Optical Remote Sensing Lab - NOAA CREST,
City College of New York, USA

Abstract

Methane is an important greenhouse gas, but methane emissions are poorly understood, in large part due to limited atmospheric methane data on local scales. Local and regional scale methane emissions data are urgently needed to improve modeling of future climate change, and support energy plans and policies to minimize future climate impacts of socio-economically needed energy utilization. There have been numerous recent reports on local ground-level ambient air methane surveys that have provided more thorough data on methane sources in some urban areas. Such surveys generate substantial amounts of high quality ground-level methane concentration data, usually with reliable time and geo-referenced location data. We examined the potential usefulness of such data sets for generation of estimates of methane emissions for surveyed areas. Our efforts focused on development of a generally applicable, relatively simple mass-balance approach to estimate area methane emissions from mobile, ground level ambient air methane concentration and local weather data. The data examined were collected in Manhattan, New York, USA over 5 days in late 2012. Using the ratio of methane emissions ($\mu\text{g m}^{-2}\text{s}^{-1}$) to natural gas usage ($\mu\text{g m}^{-2}\text{s}^{-1}$), the resulting methane emissions estimates for Manhattan were compared to 5 other cities (emissions reported by other investigators using other methods). The emissions estimates for Manhattan derived from ground-level mobile methane surveys were within the range of the estimates for the other cities. In addition, the emissions rates reported for the cities indicate natural gas should not be considered more climate-beneficial than other fossil fuels.

Keywords: Methane emissions, New York

Introduction

Increasing levels of greenhouse gases in the atmosphere are expected to cause the global climate to warm substantially, with associated impacts on human health, the environment and economic systems (Stocker et al., 2013). Methane is a major, potent greenhouse gas (GHG) and the predominant (>85 vol%) hydrocarbon in natural gas (NG). Unlike emissions of carbon dioxide, regarded as the predominant greenhouse gas, methane emissions cannot be reliably estimated from fossil fuel consumption data. Rapidly increasing development of unconventional NG resources, and the state of repair of NG infrastructure have raised increasingly urgent concerns that methane emissions, and associated climate impacts, are being substantially underestimated. Studies have found leakage from commercial NG system infrastructure is a substantial source of methane emissions, but the amount of data available is limited (Zimnoch, Godłowska, Necki & Rozanski, 2010; Alvarez, Pacala, Windbrake, Chameides & Hamburg, 2014; Jackson et al., 2014; Phillips et al., 2012). Methane emissions estimates based on technologically up-to-date measurements of actual methane levels in the atmosphere at the local to regional scale are urgently needed (Bellucci, Bogner & Sturchio, 2012; Dlugokencky, Nisbet, Fisher & Lowry, 2011; Fowler, 1999; Gan et al., 2010; The White House, 2014; Howarth, 2014; Alvarez, 2012; EPA-OIG, 2013).

Mobile Cavity Ring-Down Laser Spectrometers (CRDS) mounted in motor vehicles provide rapid, convenient and accurate methane measurements. Recent mobile CRDS investigations have focused on leak detection, finding on average a gas leak every 400 meters of city streets (Phillips et al., 2012; Jackson et al., 2014). Such leak surveys generate large amounts of accurate, time- and location- referenced, methane concentration data. Estimates of methane emissions based on actual, technologically up-to-date measurements, such as those provided by mobile CRDS, could help fulfill the urgent need for such estimates to enable more informed policies and effective management of NG (Bellucci et al., 2012; Dlugokencky et al., 2011; Fowler, 1999; Gan et al., 2010; The White House, 2014; Howarth, 2014; Alvarez, 2012; EPA-OIG, 2013). To our knowledge, how mobile CRDS survey data might be used to estimate area methane emissions in urban settings has not been examined or reported.

We explored the application of a simple mass-balance approach to estimate methane emissions from mobile CRDS ground level ambient air methane concentration and local weather data. It was our intention to maintain the greatest practical transparency regarding the approach, data

analysis, results and conclusions. Consequently, we intentionally avoided complex or less transparent statistical analytical methods. To our knowledge, this is the first published methane emissions method based on ground level mobile CRDS methane concentration data. The method is rapid and does not require use of aircraft, or long term, static installations of expensive equipment. Hence, we anticipate fuller development of this method could facilitate rapid collection of the methane emissions data urgently needed to improve current climate change modeling, NG utilization and management, and climate oriented energy plans and policies.

Materials and methods

Conceptual Approach

In order to determine the methane emissions for a selected area over a given time it would be necessary to sum all the emissions from all point and nonpoint sources, an impractical challenge for all but the smallest areas. Alternatively, it should suffice to calculate the flow of methane carried in the air moving over the area of interest (Fowler, 1999). In urbanized areas advection by wind and turbulence within the planetary boundary layer (PBL) can be reasonably expected to assure relatively rapid and thorough mixing from the surface to the top of the PBL (Gan et al., 2010). Calculation of the net bulk flow of methane does not require detailed micrometeorological data or data on the internal dynamics of the PBL. Assuming (i) wind advection is the major determinant of horizontal transfer, (ii) turbulence in the PBL the main determinant of vertical transfer, and (iii) vertical transfer ends at the top of the PBL, enables selection of a 3-dimensional space through which all gas emissions from the underlying land surface must move.

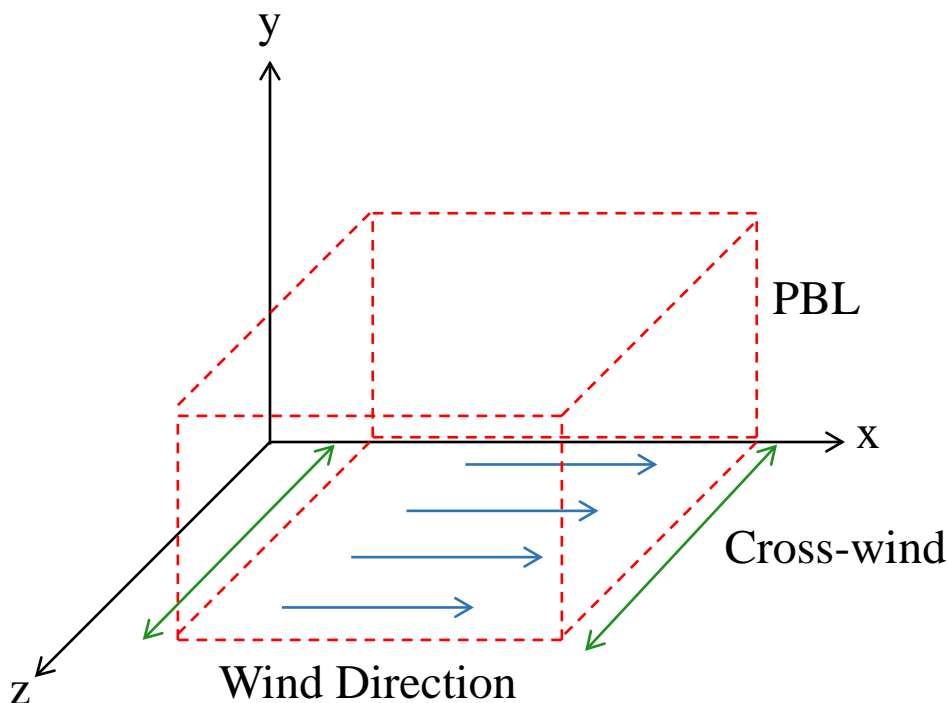

Figure 1. Main components of simple, three dimensional, mass balance box overlying rectangular surface(x - z plane) with methane emissions sources (sinks).

For simplicity of discussion we consider a simple rectangular land area as the emissions source area and ground-level methane data available from survey runs along the upwind and downwind sides of the source area (Figure 1). An overlying three-dimensional (x,y,z axes in Figure 1) “box” is designated with the height of the PBL (y), the width (x) equal to the wind-run distance between the upwind and downwind methane survey runs, and length (z) equal to the length of parallel cross-wind upwind and downwind methane survey runs. We assume negligible net wind or methane flow through the lateral walls or the top of the box (top of the PBL). The air flow rate through the upwind and downwind walls of the box are then necessarily equal as a mass balance requirement. The volume of air flow through the box can then be calculated from the crosswind length (z dimension) of the box, the PBL height (y dimension) and the wind speed (velocity along x -axis, x interval per unit time). The net methane emissions from (or removal by) the land area on the floor of the box is then the product of the volumetric rate of air flow through the downwind wall and the change in average methane concentrations between the upwind and downwind survey runs of the estimation area.

The approach requires or assumes the following:

1. Wind speed and direction data.
2. Negligible net flow of methane through the top of the PBL.
3. Sufficient methane concentration data to allow calculation of methane concentrations in well mixed air along the upwind and downwind sides of the target measurement area.
4. Wind and weather conditions that favor rapid horizontal and vertical dispersion of emitted methane throughout the PBL so that the methane concentration in well mixed ground level air will be effectively equal to the methane concentration along any overhead horizontal transect in the PBL.¹

Generally, there is limited mixing between the PBL and overlying atmosphere (Piiroinen, 1996). Meteorological data, including PBL data, for Manhattan were available at <http://nycmetnet.cuny.cuny.edu> (Legbandt, T.) Our street survey of Manhattan provided ground level methane data.

Well and Poorly Mixed Air: Data Filtering

The reliability of a simple mass balance approach based on mobile platform CRDS ground level methane measurements depends on the assumption that the sampled air is well mixed. Initially we accepted the assumption that point sources of methane were sufficiently infrequent in overall methane survey data sets that they would have minimal impact on estimates based on a mass balance approach (Payne and Ackley, 2013). However, in the present effort we were working with a previously collected data set, originally designed only to scout for gas leaks, not to estimate methane emissions. Consequently, we had to select emissions estimate target areas for which small subsets of the methane survey data met the requirements for the mass balance approach. Each such area is only a small portion of the much larger methane survey data set. As the size of the emissions target area becomes smaller, the potential for overestimation errors due to high methane readings in poorly mixed air associated with point sources near the survey path increases. Consequently, it was necessary to find a means of filtering the available data to remove effects of sampling poorly mixed air.

For the purposes of a simple mass balance approach, well mixed air is that which is commonly present in the local sampling area without direct influence of nearby methane sources on methane concentration. The

¹ This condition is likely met in the PBL over Manhattan, but will often not be met in other environments. In those cases, it appears likely that there will be a decrease in methane concentration with increasing altitude in the PBL (Zimnoch, 2010; Mays, 2009). The present approach will remain useful in such other environments provided a reliable algorithm for change in methane concentration with altitude in the PBL is available or can be developed.

methane concentration in well mixed air will vary due to turbulence and other factors, but collectively the variations will be randomly distributed within a relatively narrow range around the well mixed air mean methane level. Methane emissions from sources sufficiently far upwind of the sample location will be well mixed into the air. Methane from nearby sources will be apparent as excursions from the typical range for local well mixed air. The time and space duration of the methane concentration excursion due to a local source depends on the emission rate from the source, local physical features, and wind and atmospheric conditions (Jackson et al., 2014). Similarly, excursions to methane levels below locally typical levels can occur due to turbulence related intrusions of air from outside the local vicinity (edge effects), or temporary excursions in instrument function. Our direct examinations of CRDS methane survey data from Manhattan and numerous other areas confirm these typical variation patterns and relationships for well mixed and poorly mixed air. Given the amounts of data involved, direct examination of all the variations in methane survey data sets is not practical. We developed a relatively simple method for distinguishing well mixed air from poorly mixed air data.

Our data filter is based on recognition that the variations in methane concentrations in well mixed air will be limited in range, relatively consistent, and generally symmetrical in the rise to and fall from maxima (or minima). Variations in poorly mixed air will be larger and the ascent to and descent from maxima will be asymmetrical. It follows that if a data set is comprised of values with consistent, symmetrical, random variations around a central value, the fractiles (or quantiles) of that data set should vary consistently and uniformly, which we regard as an aspect of quantile regression analysis (Koenker, R., & Hallock, K., 2001; Cade, B. S., & Noon, B. R., 2003). In the present methane data case, a plot of methane concentration by fractiles for well mixed air should be a straight line. If the range of the data set is the same as each of the fractiles, then such a plot will have no slope. If the range of the data set is greater than that of each fractile, and the approach to and descent from maxima is symmetrical, then the methane-fractile plot will be a straight line with positive slope. If data with asymmetrical approaches to maxima (and minima) occur in the data set they will cause the methane-fractile plot to deviate from linearity.

We found the use of 100-fractiles, i.e., percentiles, to be convenient in that it provides reasonable resolution while facilitating visual accessibility and data processing. Examination of numerous methane survey data sets using methane-percentile plots confirmed the expected linearity and deviations in every case. We used the Excel linear trend line capability (least squares best fit) iteratively to adjust the low and high percentile bounds on the trend line until r^2 was maximized. Linear regressions could always be

bounded to have r^2 greater than 0.98, usually greater than 0.99 (Figure 2.). The equation of the maximized- r^2 trend line was then evaluated at the 50th percentile to determine the representative methane level for well mixed air along that methane survey path.

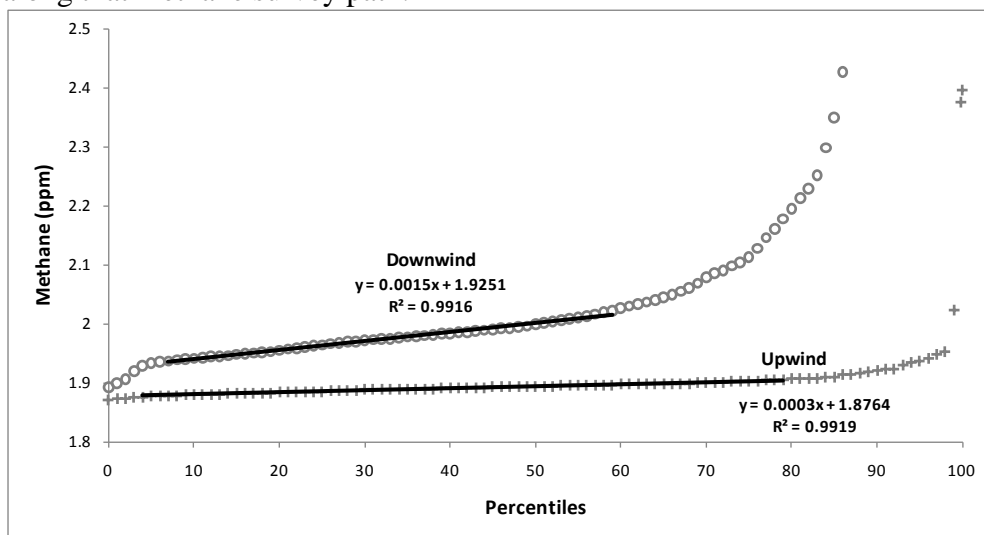

Figure 2. Methane-percentiles plots for Upwind and Downwind ground level methane survey data sets for the Southeast Lower Manhattan methane emissions estimate area (discussed below).

The mass balance approach requires comparison of methane levels at upwind and downwind locations. In practice the amount of data available for upwind and downwind locations is often not the same. The use of methane-percentile plots to examine every data set of interest effectively normalizes all the data sets to a basis with which most investigators are familiar, facilitating comparisons and communications.

Ambient Air Methane Measurements

Over a period of 5 days from 27-30 November and on 9 December 2012 we surveyed a total of 165 miles of streets in Manhattan, NYC, NY (Payne Jr., B.F. & Ackley, R., 2012, December 12) in the manner reported by Jackson et al. (2014) for their gas leaks survey of the streets of Washington, D.C. We used the same Cavity Ring-down Spectrometer (CRDS) and the same measurement and calibration procedure, run by the same operator (Robert Ackley). We have found under mobile field use conditions the CRDS instruments we have used to be reliably sensitive to $\pm 2\%$ relative and a typical minimally sized data set ($N > 40$) for areas with stable methane levels to have a 99% ($\alpha = 0.01$) confidence interval around 0.1% relative.

Methane Data Processing

The data were compiled and processed using Microsoft Excel and a program (which we refer to as XTL) in R developed by Xiaojing Tang of Boston University with subsequent revisions by Jacob Lysinger. The program reduced the amount of manual data processing required by performing five tasks. XTL reduced the size of the raw data sets by deleting instrument function parameters and reducing reported accuracies to appropriate levels, .e.g., 0.001 ppm for methane. XTL moved any data records that included out of range methane levels to a separate file. The normal range limits are adjustable and were set to collect data from reference gas runs to check instrument function or other unusual deviations in instrument behavior. XTL eliminated redundant data that accumulated during necessary stops of the survey vehicle due to traffic or other operational requirements. XTL used GPS data to identify methane data for any stop lasting more than 1 second, calculated the average methane concentration for that stop, moved all the original data for the stop to a separate file and inserted a single entry of the average methane concentration for that location back into the data set. XTL then determined the maximum, minimum, average, median and 1st to 99.9th percentiles for the processed data set. XTL always generates at least 3 files: a program processing log, the processed methane survey data set, and a statistical summary. XTL may generate more files if there are out of range data or stop location data. We elected to set the maximum size of output files at 100,000 lines. Consequently, for large raw data sets XTL will report the whole processed data file as a sequential series of 100,000-line files.

Mixing in the Planetary Boundary Layer and Meteorological Data

On 19-20 June 2013 we undertook a limited investigation of the lower portion of the PBL. We measured methane concentrations at ground level and outside 8 buildings in Manhattan at elevations from 20 to 164 meters above street level. Analysis of the data indicated methane concentrations were consistent from street level to a height of at least 164 meters above street level. Based on that data and ceilometer data we concluded that it was reasonable to treat the PBL (mixing layer) as uniformly mixed at the sampling times of concern.

The height of the PBL during relevant sampling periods was estimated from ORSL ceilometer data (retrieved from <http://sky.cuny.cuny.edu/wc/Thales/index.php> or processed and supplied directly by the ORSL).

Results and discussion

Winds and the Planetary Boundary Layer

Winds were generally northeasterly (NE, bearing 20°-70°, 3-day average 40°) on 27 and 30 November and 9 December, and generally west-southwesterly (WSW) on 28 November (bearing 270°-290°) and 29 November (230°-260°, 2-day average 240°). Average wind speeds were similar for the two wind-direction data sets (average 3.0 m·s⁻¹ for NE wind days, and 3.4 m·s⁻¹ WSW wind days), but those averages contained wide variations (1.3-5.8 m·s⁻¹) and 35% of wind direction data values were missing or “variable”. Average wind speed during the sampling time for a given data run serves as the net horizontal movement proxy value in the mass balance methane emissions calculation. It was, therefore, necessary to better account for “variable” wind direction data. Wind data entries with “variable” direction data typically have no associated wind speed data. Average wind speed could be calculated using only wind speed/direction pairs that were not “variable”. However, a “variable” wind data entry implied wind was not blowing consistently in any predominant direction, and, hence, there was no net horizontal displacement of air during that time interval. Consequently, we set wind speed associated with any period of “variable” direction to zero and included that wind data in calculation of the average wind speed. This reduced the average wind speed in proportion to the number of “variable” wind direction entries in the wind data record for each emissions estimate area, better reflecting the impacts of periods with no net horizontal movement of the air and methane it contained.

During sampling on the two WSW wind days (28 and 29 November) the PBL was relatively stable with a height around 800 meters. During NE-winds sampling on 30 November the PBL was reasonably stable at a height of around 1000 meters, but over a period of 4 hours on 27 November the PBL collapsed to a height of around 100 meters apparently in association with a drop in barometric pressure (30.13-30.06 in.Hg, 1.007-1.004 atm).

Indications from the Methane Survey Data

Multiple analyses of the available methane survey data for the whole island indicated about half the methane emissions likely occurred south of latitude 40.755 (east-west line roughly through the end-to-end center of 42nd Street). Methane emissions appeared to be clustered in the lower East Side, and in areas where construction is densest, especially 34th Street to Central Park, and in the Financial District.

The methane survey was not designed to collect data for the purpose of estimating methane emissions; hence, most of the collected data was not appropriately positioned in space and time to support estimates of methane emission rates. We undertook detailed examination of the data files in an

attempt to identify data subsets that contained reasonably time and space related methane survey data to generate more quantitative estimates of methane emissions for the areas covered by such subsets.

The simple mass balance approach we propose suggests the net methane emissions from (or removal by) the target land area is the product of the volumetric rate of air flow across the downwind edge of that land area and the difference between representative (linear trend 50th percentile) methane concentrations in well mixed air for survey runs along the downwind and upwind sides of the land area. Consequently, data sets are well positioned in time and space when they run along areas that are upwind and downwind with respect to each other, and both were collected within a reasonable time frame.

Ideally the time between the upwind and downwind runs would be the time required for the wind to traverse the area between. This ideal time separation is difficult to achieve under field conditions as timing of runs may be entirely determined by traffic, etc. In most urban areas the numbers, locations and emission rates of methane sources within a target measurement area are not likely to change over time intervals in the range of a few hours to days. However, wind and PBL dynamics determine where and how fast methane from emissions sources moves. Consequently, appropriate time intervals between up- and downwind runs, is often determined by the duration of consistent wind conditions and PBL height, either or both of which can change over periods as short as a few minutes. For this investigation of our proposed simple mass-balance method, we searched for data subsets comprised of runs with reasonable time and distance separations and reasonably consistent wind and PBL conditions.

Our search encountered the areas marked in Figures 3 and 4. The methane survey data for these areas was sufficient to support experimental application of our simple mass balance emissions estimate method.



Figure 3. Areas with sufficient methane survey data to support experimental application of simple mass balance emissions estimate method. Bold yellow and red arrows indicate predominant wind direction on days for which there was available methane survey data for areas marked with the same colors (yellow or red). There were 3 areas in Lower Manhattan (see Figure 4).



Figure 4. Areas in Lower Manhattan with sufficient methane survey data to support experimental application of simple mass balance emissions estimate method. Bold yellow and red arrows indicate predominant wind direction on days for which there was available methane survey data for areas marked with the same colors (yellow or red). Bold arrows also indicate area sides where no methane data was collected, i.e., sides between the upwind and downwind sides.

Methane Emissions Estimate Areas

Cross County Parkway (CCP) in Brooklyn inbound to Manhattan, 27 November 2012: upwind run (11:26-11:28 AM, $N=381$, 40.94918, -73.7985 to 40.92729, -73.81230) north and downwind run (11:29:09-11:29:58 AM, $N=180$, 40.92323 -73.82270 to 40.92662 73.83547) west of a right angle turn in the Parkway around lat. 40.9225 long. -73.8170. Wind from 60° at $2.7 \text{ m}\cdot\text{s}^{-1}$. PBL height at 50m. Cross wind dimension 1 km. Land area 2.57 km^2 . Simple difference between well mixed air 50th percentile methane concentrations (downwind – upwind) = 0.016 ppm indicated a methane emissions rate of $0.6 \mu\text{g}\cdot\text{m}^{-2}\cdot\text{s}^{-1}$. Due to remoteness from the weather station

and ceilometer in Manhattan, the PBL and wind data were considered most likely sources of error.

North Upper Manhattan (NUM), 27 November 2012, downwind run on Broadway from 181st Street (12:29-12:36, N= 936, 40.85028 -73.93581) to Thayer Street (40.86494 -73.92850), upwind reference run in Brooklyn on Major Deegan Expressway along east side of Harlem River (11:36-11:40, N= 481, 40.8860 -73.8967 to 40.8632 -73.91141). Wind from 50° at time/direction adjusted speed of 0.6 to 1.2 m·s⁻¹. PBL height at 55m. Cross-wind dimension = 1.17km. Land area = 2.5 km². Simple difference between well mixed air 50th percentile methane concentrations (downwind – upwind) = 0.11 ppm indicated a methane emissions rate of 1 to 3 μg·m⁻²·s⁻¹, with uncertainties again due primarily to remoteness from sources of wind and PBL data.

Northwest Lower Manhattan (NWL), 29 November 2012, downwind run the length of 34th Street (16:59-17:22, N=2751, 40.74439 -73.97461 to 40.775710 -74.00493), upwind reference run on Lincoln Highway from 34th to Canal Streets (17:22-17:36, N=1196 , 40.75706 -74.00496 to 40.72647 -74.0111). Wind from 240° at 3.6 m·s⁻¹. PBL height at 800m. Cross-wind dimension = 2.75km. Land area = 5.2 km². Simple difference between well mixed air 50th percentile methane concentrations (downwind – upwind) = 0.111 ppm indicated a methane emissions rate of 110 μg·m⁻²·s⁻¹.

Southeast Lower Manhattan (SEL), 29 November 2012, downwind run the length of the FDR Drive from near the East River Park Amphitheater to 34th Street (16:25-16:59, N=4980, 40.71157 -73.97845 to 40.74438 -73.97459), upwind reference run on Lincoln Highway from Canal Street southward continuing eastward onto FDR Drive to near the East River Park Amphitheater (16:17-16:25, N=1319, 40.72647 -74.0111 to 40.71153 -73.97850). Wind from 240° at 3.6 m·s⁻¹. PBL height at 800m. Cross-wind dimension = 2.75km. Land area = 9.2 km². Simple difference between well mixed air 50th percentile methane concentrations (downwind – upwind) = 0.109 ppm indicated a methane emissions rate of 62 μg·m⁻²·s⁻¹.

East Lower Manhattan (ELM), 30 November 2012, downwind run on Grand Street from West Broadway to Essex Street (15:44:12-15:45:42, N=2369, 40.72400 -73.97337 to 40.73491 -73.97393), upwind reference run on FDR from near 10th Street to near 23rd Street along East River (13:37-14:20, N=156, 40.72241 -73.00371 to 40.71729 -73.98892). Wind from 60° at time/direction adjusted speed of 1.3 m·s⁻¹. PBL height at 1000m. Cross-wind dimension = 1.09km. Land area = 2.35 km². Simple difference between well mixed air 50th percentile methane concentrations (downwind – upwind) = 0.266 ppm indicated a methane emissions rate of 110 μg·m⁻²·s⁻¹.

Emissions Estimate Area	Wind Dir.	Wind Speed ($\text{m}\cdot\text{s}^{-1}$)	PBL Height (meters)	X-wind length (km)	Land Area (km^2)	Estimated Methane Emissions Rate ($\mu\text{g}\cdot\text{m}^{-2}\cdot\text{s}^{-1}$)
Cross County Parkway (CCP)	60	2.7	50	1	2.57	0.6
North Upper Manhattan (NUM)	50	0.6-1.2	55	1.17	2.5	1-3
East Lower Manhattan (ELM)	60	1.3	1000	1.09	2.35	110
Northwest Lower Manhattan (NWL)	240	3.6	800	2.75	5.2	110
Southeast Lower Manhattan (SEL)	240	3.6	800	2.75	9.2	62

Given the uncertainties in wind and PBL data and the coarseness of our estimates of the dimensional parameters of the emissions estimate areas, the emissions estimates were all plausible or consistent. The estimated methane emissions rates for the Cross County Parkway and North Upper Manhattan areas from 27 November data are comparable to each other and rates reported for similar urban/suburban settings by others (Jackson, 2014; Mays et al., 2009; McKain et al., 2015). The CCP area was remote from the Central Park weather station and the ORSL ceilometer location. The height of the PBL was changing rapidly during the methane survey of the North Upper Manhattan area. Consequently, emissions rates were reported as ranges because of uncertainties in the wind and PBL height data.

The 3 Lower Manhattan areas emissions estimates were in good agreement, the NWL and ELM emissions being equal at $110 \mu\text{g}\cdot\text{m}^{-2}\cdot\text{s}^{-1}$. The estimate for the SEL area at $62 \mu\text{g}\cdot\text{m}^{-2}\cdot\text{s}^{-1}$ was 45% lower than those for the NWL and ELM areas. This lower result may be an example of the potential error inherent in use of only well mixed air methane concentration data. Methane in poorly mixed air on the downwind side of a target area is part of the emissions within that target area. The well-mixed-air-only restriction necessarily imposes the potential for underestimating total emissions if a locally potent source is close to the downwind side of the target area. The ELM area was contained within the SEL area, and both contained the Con Ed East River Generating Station. The Generating Station was just inside the upwind side of the ELM, and just inside the downwind side of the SEL.

Methane from the Station would have been undetected on the upwind side and well mixed into the air on the downwind side of ELM and not removed by the well-mixed-air data filtration. In contrast, in the SEL the Station was just inside the downwind side, hence, poorly mixed, and recognized and removed by the well-mixed-air data filtration. Direct examination of the data indicated a substantial, typical, poorly mixed air methane excursion downwind of the Station in the SEL data set. Further, when the SEL emissions estimate was calculated without applying the well-mixed-air-only data filter the estimate increased to $125 \mu\text{g}\cdot\text{m}^{-2}\cdot\text{s}^{-1}$, only 14% higher than the estimates for the ELM and the NWL. This result supports the likely conservative validity of the emissions estimates for Lower Manhattan (below 34th Street) at $110 \mu\text{g}\cdot\text{m}^{-2}\cdot\text{s}^{-1}$, and suggests the East River Generating Station is a substantial local source of methane emissions.

Sources of Error

The proposed simple mass balance method requires measurement input values for wind speed, planetary boundary height, wind-run and cross-wind dimensions of the target area, and the difference between upwind and downwind well mixed air methane levels. We estimate the error in the well mixed methane measurements to be 0.5%. We estimate the relative errors for wind speed, PBL height and wind-run and cross-wind dimensions of the target area to be, respectively, 20%, 10%, 5% and 5%. Error propagation for a simple product model implies an overall error in our emissions estimate of less than 25%. The calculation of the whole island estimated emissions is a further simple product, which, assuming a 30% error in our estimated distribution of emissions over the island, leads to a propagated error of less than 40%. Further development of the method and supporting data collection efforts can be expected to substantially reduce these errors.

Plausibility of Results -- Comparison to Other Methods in Other Cities

The accuracy of the method is also potentially affected by three other factors: (i) the exclusion of poorly mixed air methane data, (ii) the assumption of effectively uniform vertical mixing throughout the PBL and (iii) that no methane is transferred through the top of the PBL. Exclusion of poorly mixed air methane data (i) is likely to cause considerable underestimate of emissions. This was illustrated by the results for the SEL and the ELM areas as discussed above. Exclusion of poorly mixed air data caused emissions in the SEL to be underestimated by an apparent 44%, while inclusion caused an apparent 13% overestimate, compared to the ELM. (ii) If the methane were transferred upward through the top of the PBL the assumption of no transfer would also cause an underestimate of emissions. (iii) The limited data and information we have suggests that vertical mixing

in the PBL is probably complete over Manhattan. If it were not, then the emissions estimate would be overestimated, but not likely by more than 25%. Hence, the emissions estimates we calculated for Manhattan are more likely to be too low than too high. The impacts of these factors can be managed in further development of the method.

We sought to evaluate the plausibility of our emissions estimates for Lower Manhattan. We were unable to locate other methane emissions estimates based on actual methane measurements for Lower Manhattan or other sub-city urban areas. As an alternative we undertook a comparison of our Manhattan results to those reported for other cities. To make such a comparison it was necessary to get all the cities methane emission rates onto the same basis.

We extrapolated the Lower Manhattan emissions rates to generate an emission rate for all of Manhattan by applying the relationship developed from our general analyses of methane survey data for all of Manhattan, i.e., that half of all emissions on the island occur south of 42nd Street. The extrapolated whole-island Manhattan methane emission rate was $66 \mu\text{g}\cdot\text{m}^{-2}\cdot\text{s}^{-1}$, which is the equivalent of 6.6 billion cubic feet of methane per year, or about 6.6% of the volume of natural gas used in Manhattan per year.

We located reports of related methane emissions estimates for 5 other cities (Table 2), Krakow, Poland (Kuc, Rozanski, Zimnoch, Necki & Korus, 2003; Zimnoch et al., 2010), London, UK (Helfter, Nimitz, Barlow & Wood, 2013), and in the U.S.A., Boston, Massachusetts (McKain et al., 2015), Indianapolis, Indiana (Mays et al., 2009), and an unidentified 'Small Town' in the US Midwest (Lamb et al., 1995). Zimnoch et al. (2010) measured PBL height by SODAR (sonic distance and ranging) and methane using gas chromatography and selected nighttime data to take advantage of stable PBL conditions. Helfter et al. (2013) used eddy covariance carbon dioxide and methane data and methane/carbon dioxide ratios to back calculate over time methane emissions for central London. Lamb et al. (1995) used a tracer release technique to estimate methane emissions. McKain et al used 4 static CRDS installations to measure methane levels for a year at 2 locations in Boston, 1 reference site outside Boston and 1 reference site outside the Boston urban region. Mays et al. (2009) used an aircraft-borne CRDS and other instrumentation to assess methane concentration, wind speed, PBL height, etc. The reported methane emissions rates for those four cities ranged from 0.43 to

$2 \mu\text{g}\cdot\text{m}^{-2}\cdot\text{s}^{-1}$, considerably lower than our estimate for Manhattan at $66 \mu\text{g}\cdot\text{m}^{-2}\cdot\text{s}^{-1}$. However, the five cities range widely in population density (66,000 persons km^{-2} in Manhattan to 440 in the Boston urban region) and gross annual NG consumption (12330 Gg yr^{-1} in the Boston urban region to 49 Gg yr^{-1} in 'Small Town').

In urban areas, the intensity of NG usage will be related to population. Gas flow rates and size and complexity of gas distribution systems can be reasonably expected to increase in proportion to the number of customers being served. With a daytime population density of around 66,000 persons km⁻², Manhattan is 6 times more densely populated than the next densest, London, at 11,000 persons km⁻² (Helfter et al., 2013; Moss & Qing, 2012). Those populations are served with NG, but delivery and use efficiencies can be expected to vary among cities. As a more concise approach we examined total NG usage per unit area for the 5 cities, and compared them on an equivalent gas usage density basis (Table 2).

Table 2. Natural Gas Usage and Methane Emissions in Five Cities.

City	Natural Gas Usage		Methane Emissions		
	Annual	Area•time density basis	Area•time density basis	On a Manhattan gas usage density basis	As percent of usage density
	Gg yr ⁻¹	μg m ⁻² s ⁻¹	μg m ⁻² s ⁻¹	(Units ^a)	%
Manhattan NYC US 2012	1800	1000	66	66	6.6
Indianapolis IN US 2008	920	28	2.2	79	7.9
"Small Town" US	49	68	2.2	32	3.2
Boston Urban Region US '12-'13	12330	22	0.59	27	2.7
Krakov Poland '96-'97	220	22	0.62	28	2.8
Krakov Poland '05-'08	300	29	0.43	14	1.4
London (4 boroughs) UK 2012	610	260	2.2	8	0.8
^a μg methane emissions m ⁻² s ⁻¹ per 1000 μg NG usage m ⁻² s ⁻¹					

The five cities range widely in gross annual NG usage (Gg yr⁻¹). When NG usage is considered on an area-time density basis (μg•m⁻²s⁻¹), Manhattan usage density (1000 μg•m⁻²s⁻¹), is nearly 4 times denser than that of London (μg•m⁻²s⁻¹), almost 36 times denser than that of Indianapolis (28 μg•m⁻²s⁻¹), more than 45 times denser than that of the Boston urban region. The Indianapolis emissions/usage-density ratio 79 was the highest. The ratio for Manhattan was 66. "Small town", Krakow in 1996-1997 and the Boston

urban region had similar ratios of 32, 28, and 27, respectively. Krakow in 2005-2008 and London had substantially lower ratios at 14 and 8, respectively. Zimnoch et al. (2010) suggested the apparent decrease in emissions in Krakow between 1996-1997 and 2005-2008 may have been due to a gas infrastructure improvement program. Given the age, size and complexity of the NG gas distribution system in Manhattan, both the emissions/usage-density ratio and, hence, our emissions estimate of $66 \mu\text{g}\cdot\text{m}^{-2}\cdot\text{s}^{-1}$ appear plausible.

Implications

Methane emissions from NG infrastructure have become a matter of some concern, especially with respect to the proposition that increased use of NG in place of other fossil fuels will result in lower GHG emissions per unit of useful energy. Investigations of urban methane emissions have consistently found much of the methane is from the local NG system (Zimnoch et al., 2010; Jackson et al., 2014; Belluci et al., 2012). Other recognized potential methane sources include automobiles and other combustion sources, sewage systems, landfills, wetlands, agricultural facilities. There are no agricultural facilities, wetlands, sewage treatment plants or waste landfills in Lower Manhattan. Using the automobile methane emissions rate (1.5×10^{-4} g CH₄ per g CO₂) of Nam, Jensen and Wallington (2004) and commuter and traffic estimates (Moss & Qing, 2012) we estimated vehicle methane emissions would not likely exceed $2 \mu\text{g}\cdot\text{m}^{-2}\cdot\text{s}^{-1}$ in Manhattan, and the total methane emissions due to incomplete combustion in vehicle and non-vehicle sources should not exceed $5 \mu\text{g}\cdot\text{m}^{-2}\cdot\text{s}^{-1}$. Consequently, we concluded it is likely that something approaching 90% of our estimated

$66 \mu\text{g}\cdot\text{m}^{-2}\cdot\text{s}^{-1}$ methane emitted in Manhattan was likely from the NG system, which will include leaks at point of use.

It appears that in most cities with NG service, most of the methane emissions are the collective effect of local NG infrastructure and utilization technology, and, consequently represent the distribution system component of total leakage for the NG production-transmission-distribution system. Considering methane emissions (NG leakage) on a NG-usage-area-density basis (Table 2) eliminates the need to consider all possible types of NG leaks (compressors, regulators, valves, lines, point of use, etc.). Methane emissions in the 5 cities ranged from 0.8% to 7.9% of the gas usage. In Indianapolis and Manhattan methane emissions amounted to 6.6%-7.9% of gas usage. Even in the Boston urban region, which includes large non-urban areas, methane emissions were 2.7% of the gas used.

The greenhouse gas (GHG) impact break-even point for NG-versus-coal (for power production) has been estimated at a total NG system leakage

rate of 2.8% of total NG production from well drilling through delivery and use (Alvarez et al., 2013; Howarth, 2014). Based on methane emissions estimates for the 5 globally prominent cities and a small US town, 2/3 of urban NG distribution systems exceed the GHG (electric power production) break-even gas leakage for the entire NG production-through-consumption system. None of the 4 US cities had a leakage rate below the 2.7%. Even for the US city with the lowest likely NG-related methane emission rate there is no plausible leakage rate for the upstream segments (production and transmission) of that NG stream that would allow NG to be construed as GHG advantageous with respect to other fossil fuels for electric power production. The dominant use of natural gas in the US (>60%) is combustion to generate heat for residential and industrial purposes, not electric power production. The energy conversion efficiency advantages of gas for electric power production do not apply to combustion for heat production. Consequently, the methane emissions (NG leakage) rates that support a GHG advantage for natural gas over other fossil fuels are much lower, making use of NG for heating GHG-disadvantageous at the emissions rates reported for the 6 cities we considered.

Conclusion

We developed a generally applicable, simple method for calculating methane emissions from distributed ground level ambient air methane concentration, weather and PBL data. Methane data for Manhattan showed concentrations consistently increased from upwind to downwind areas on the island. The method provided plausible consistent estimates of methane emissions in Lower Manhattan even though methane survey data were collected under different wind conditions and in nested or separate neighboring areas. Our simple calculation based on changes in methane concentrations, wind speed, height of the planetary boundary layer and observed relative differences between the northern and southern parts of the island generated an estimated methane emissions rate of $66 \mu\text{g}\cdot\text{m}^{-2}\cdot\text{s}^{-1}$ for the whole island, and plausible rates for 2 less densely populated areas in the region. We examined methane emissions as a function of NG usage density to compare the Manhattan emissions rate indicated by our method to rates reported for 5 other cities by other investigators using other methods. Our estimated emission rate for Manhattan was within the range of rates among the other 5 cities. The emissions estimates for the 6 cities indicated use of natural gas in lieu of other fossil fuels will not provide any climate change advantage, and will likely do more harm than good. We conclude the proposed simple mass balance methane emissions estimation method based on mobile CRDS data produced plausible results even with only opportunistic data sets. The method should be considerably more effective if

wind, PBL, and methane data can be collected in data surveys designed for the purpose of estimating emissions. Further efforts to apply the method opportunistically with respect to other previously collected data sets could rapidly generate measurement-based methane emissions estimates for numerous other areas. More fully developed and applied the method could substantially contribute to meeting the need for methane emissions data, and should be adaptable to other trace gases for which similar mobile measurement capabilities are available.

Acknowledgements

Funding and additional support was provided by Damascus Citizens for Sustainability (<http://www.damascuscitizensforsustainability.org/>) and A. Payne. We wish to acknowledge the efforts in Manhattan of R. Hardinger and R. Smith for arranging building access, assisting with navigating in the city, and numerous other contributions of personal time and resources. We are grateful for the assistance provided by C. Helfter, M. Zimnoch and L. Payne, for reviews and comments provided by B. Redmond, D. Lemly, J. Skorupa and others too numerous to mention.

References:

- Alvarez, R. A.; Pacala, S. W.; Windbrake, J. J.; Chameides, W. L.; Hamburg, S. P., Greater focus needed on methane leakage from natural gas infrastructure. *Proceedings of the National Academy of Sciences of the United States of America* **2014**, *109* (17), 6435-6440.
- Bellucci, F.; Bogner, J. E.; Sturchio, N. C., Greenhouse Gas Emissions at the Urban Scale. *Elements* **2012**, *8*, 445-449.
- Cade, B. S., & Noon, B. R. (2003). A gentle introduction to quantile regression for ecologists. *Frontiers in Ecology and the Environment*, *1*(8), 412-420.
- Dlugokencky, E. J.; Nisbet, E. G.; Fisher, R.; Lowry, D., Global atmospheric methane: budget, changes and dangers. *Philos Trans A Math Phys Eng Sci* *369* (1943), 2058-72.
- EPA-OIG (2013). U.S. Environmental Protection Agency-- Office of Inspector General. *EPA Needs to Improve Air Emissions Data for the Oil and Natural Gas Production Sector*. Report No. 13-P-0161. February 20, 2013.
- Fowler, D., Experimental designs appropriate for flux determination in terrestrial and aquatic ecosystems In *Developments in Atmospheric Science - Approaches to Scaling of Trace Gas Fluxes in Ecosystems*, Bouwman, A. F., Ed. Elsevier BV: Amsterdam, 1999; Vol. 24.
- Gan, C.-M.; Wu, Y.; Gross, B. M.; Arend, M.; Moshary, F.; Ahmed, S., A comparison of estimated mixing height by multiple remote sensing

- instruments and its influence on air quality in urban regions. In *IEEE International Geoscience & Remote Sensing Symposium, IGARSS 2010*, Honolulu, Hawaii, USA, 2010.
- Helfter, C.; Nemitz, E.; Barlow, J. F.; Wood, C. R., Carbon dioxide and methane emission dynamics in central London (UK). *Geophysical Research Abstracts* **2013**, *15* (EGU2013), 7036.
- Howarth, R.W. (2014) A bridge to nowhere: methane emissions and the greenhouse gas footprint of natural gas. *Energy Science and Engineering*. (open access, accepted 22 April 2014). doi: 10.1002/ese3.35.
- Jackson, R. B.; Down, A.; Phillips, N. G.; Ackley, R. C.; Cook, C. W.; Plata, D. L.; Zhao, K. 2014. Natural Gas Pipeline Leaks Across Washington, DC. *Environ Sci Technol* **48** (3), 2051-8. doi: 10.1021/es404474x.
- Koenker, R., & Hallock, K. (2001). Quantile regression: An introduction. *Journal of Economic Perspectives*, *15*(4), 43-56.
- Kuc, T.; Rozanski, K.; Zimnoch, M.; Necki, J. M.; Korus, A., Anthropogenic emissions of CO₂ and CH₄ in an urban environment. *Applied Energy* **2003**, *73*, 193-203.
- Lamb, B. K.; McManus, J. B.; Shorter, J. H.; Kolb, C. E.; Mosher, B.; Harriss, R. C.; Allwine, E.; Blaha, D.; Howard, T.; Guenther, A.; Lott, R. A.; Siverson, R.; Westburg, H.; Zimmerman, P., Development of atmospheric tracer methods to measure methane emissions from natural gas facilities and urban areas. *Environ Sci Technol* **1995**, *29* (6), 1468-79.
- Legbandt, T. NYCMetNet. <http://nycmetnet.cuny.cuny.edu>.
- Mays, K. L.; Shepson, P. B.; Stirm, B. H.; Karion, A.; Sweeney, C.; Gurney, K. R., Aircraft-based measurements of the carbon footprint of Indianapolis. *Environ Sci Technol* **2009**, *43* (20), 7816-23.
- McKain, K., Down, A., Raciti, S.M, Budney, J., Hutyra, L.R., Floerchinger, C., Herndon, S.C., Nehrkorn, T., Zahniser, M.S., Jackson, R.B., Phillips, N., Wofsy, S.C. 2015. Methane emissions from natural gas infrastructure and use in the urban region of Boston, Massachusetts. *Proceedings of the National Academy of Sciences of the United States of America* *112*(7) 1941–1946. doi: 10.1073/pnas.1416261112.
- Moss, M. L.; Qing, C. *The Dynamic Population of Manhattan*; Rudin Center for Transportation Policy and Management, Wagner School of Public Service, New York University: New York, New York, 2012.
- Nam, E. K.; Jensen, T. F.; Wallington, T. J., Methane Emissions from Vehicles. *Environmental Science and Technology* **2004**, *38*, 2005-2010.
- Payne Jr., B.F. & Ackley, R. (2012, December 16). Report on a Preliminary Investigation of Ground-Level Ambient Methane Levels in Manhattan, New York City, New York. Retrieved from <http://documents.dps.ny.gov/public/Common/ViewDoc.aspx?DocRefId={B D0C41AF-925B-425E-A17A-1EF5ABAFAC19}>.

- Payne Jr., B.F. & Ackley R. (2013, March 11). Extended Report on a Preliminary Investigation of Ground-Level Ambient Methane Levels in Manhattan, New York City, New York. Retrieved from <http://www.damascuscitizensforsustainability.org/wp-content/uploads/2013/03/Manhattan-Final-report.pdf>.
- Phillips, N. G.; Ackley, R.; Crosson, E. R.; Down, A.; Hutyra, L. R.; Brondfield, M.; Karr, J. D.; Zhao, K.; Jackson, R. B. 2012. Mapping urban pipeline leaks: methane leaks across Boston. *Environ Pollut* 173, 1-4. doi: 10.1016/j.envpol.2012.11.003.
- Piironen, Antti. 1996. Atmospheric Boundary Layer Structure. Retrieved from http://lidar.ssec.wisc.edu/papers/akp_thes/node6.htm.
- Stocker, T. F.; Qin, D.; Plattner, G.-K.; Tignor, M.; Allen, S. K.; Boschung, J.; Nauels, A.; Xia, Y.; Bex, V.; Midgley, P. M.; (eds.) *Climate Change 2013: The Physical Science Basis. Contribution of Working Group I to the Fifth Assessment Report of the Intergovernmental Panel on Climate Change*; Intergovernmental Panel on Climate Change: Cambridge, UK and New York, NY, USA, 2013.
- The White House (2014). *Climate Action Plan: Strategy to Reduce Methane Emissions*. March 2014.
- Zimnoch, M.; Godłowska, J.; Necki, J. M.; Rozanski, K., Assessing surface fluxes of CO₂ and CH₄ in urban environment: a reconnaissance study in Krakow, Southern Poland. *Tellus* 2010, 62B, 573-580.

“USE OF BIOMASS RESOURCES FROM FOREST AND INDUSTRIAL RELATED ACTIVITIES FOR GENERATION OF ENERGY IN THE ALUMINE AREA, PROVINCE OF NEUQUEN”

Alejandro Gallino
María Inés Jatib
Horacio Repetto
Marina Bentivegna
María Sol Assusa

Universidad Nacional de Tres de Febrero, Buenos Aires, Argentina

Abstract

The global context shows a significant increase in terms of energy consumption and dependence on fossil fuels, leading to high costs for the population, and its natural and social environment as well. This situation should be tackled in the very short term. Currently, the environmental impact registered has further led to the generation of new alternatives aimed at reducing this impact and maximizing sustainability. Focus has been placed on the development of renewable energy from biomass sources. In Argentina, one feasible proposed alternative consists in using forest waste for the development of bio-energy. The available inventories carried out in the Aluminé area, province of Neuquén, reveal a wide availability of suitable land for forest crops, building the necessary conditions for the forestry sector to become one of the productive activities with greater development possibilities in the Neuquén area. It is thus necessary, to introduce a paradigm shift in the energy matrix, through the use of these biomass resources derived from the forest industry activity. This change will replace, in the mid and long term and to a certain level, fossil fuels which the region currently depends on, and will make possible to achieve, in the near future, the necessary self-sufficiency and sustainability for energy development. This is initially intended for the region, and potentially nationwide.

Keywords: Biomass, forest-industrial sector, sustainability, self-management, energy paradigm.

Introduction

In any change process, it results essential to know the territory carrying capacity, its limitations, vulnerabilities and its sustainable suitability, as well. It is further necessary to identify and assess natural resources and specific ecosystems to be protected and preserved.

In terms of biomass resources, a wide range of new alternatives is identified due to the addition of the new energy matrix paradigm. All these factors demands a political approach based on the medium and long term in relation to interests, needs and constraints from the regional-local scope; that is, to be aware, from this territorial scale, of the responsibilities in the development and management.

"Indeed, the transformation of biomass is technologically relevant, not only for energy production (which can be sustainably produced by other renewable resources: solar, wind, geothermal ...); but due to the fact that biomass is the only renewable source available on a massive scale for the manufacturing of products, materials and carbon-based fuels"²

In 2006, Law 26,190 launched the "National Program for the promotion of renewable use of energy for electric power generation." Section 1 of this Law states: "Be it declared of national interest the generation of electric power from the use of renewable energy sources for the provision of public services, as well as the research for technology development, and the manufacture of equipment for this purpose."³ It further states that within a 10-year term, an 8% of the electricity consumption should be supplied from renewable energy sources.

Therefore, it results necessary to have an innovative approach with regards to the model of resources use, particularly in terms of energy, being capable of harmonizing economic, social, environmental and ecological variables in the regional context.

Under this premise, the main objective is to promote growth, protection and enhancement of the forestry activity and heritage in the Area of Aluminé, Province of Neuquén, as well as to increase the quantity and quality of the subsequent industrialization of the area.

² J. Arauzo y otros. "*Introducción a las tecnologías de aprovechamiento de biomasa*" [*Introduction to Biomass Use Technologies*] Available at: www.gecarbon.org/listnl.asp

³ Law 26.190 - Régimen de Fomento Nacional para el uso de fuentes renovables de energía destinada a la producción de energía eléctrica [National Program for the Promotion of Renewable Sources Use of Energy for Electric Power Generation]. Purpose. Scope. Application. Authority of Application. Policies. Investment Scheme. Beneficiaries. Benefits. Approvals. Trust Fund for Renewable Energy. Passed on December 6, 2006. Enacted on December 27, 2006. Ministry of Economy and Public Finances, Argentina. Available at: <http://infoleg.mecon.gov.ar/infolegInternet/anexos/120000-124999/123565/norma.htm>.

Likewise, the Project makes possible to develop and apply the best available technology, to promote the development of sector-related private investment, and of those companies providing associated services to every link of the industrial and forest production chain, thus ensuring social, economic and environmental sustainability of the activity. This project implies:

- An increase of areas subject to pruning and thinning in the implanted forest.
- Improved working conditions of pruning and thinning crews.
- Increased production of Abra Ancha Sawmill.
- Improved product quality of Abra Ancha Sawmill.
- Improved quality of power supply within the Project area.
- Making socially and environmentally sustainable the use and final disposal of forestry industrial waste.
- Improving environmental and social conditions in the urban area.
- Replacing local power generation, through internal combustion engines, for power generation through biomass, thus reducing the environmental impact which results from the use of fossil fuels.

Aluminé and its characteristics:

The province of Neuquén is one of the main generators of electricity in the country through hydroelectric plants located throughout the Limay and Neuquén Rivers. Furthermore, the electricity generated by the province using other sources, such as hydrocarbon resources in thermoelectric plants, mainly from the West of the province, results a relevant factor.

Neuquén has 60,000 planted hectares with exotic conifers⁴. This initiative has been developed over the last 40 years by the provincial Government, in response to the search for alternatives to the primary activity of hydrocarbon extraction.

According to the Provincial Strategy for the Agri-food industry of Neuquén, the forestry industry is considered one of the priority sectors to improve life quality of the population, pointing to the economic development related to the procurement of resources from productive activities and industrialization processes.

In order to achieve this goal, several actions are stated in different initiatives associated to the promotion of forest nurseries, forestry promotion through subsidies, implementation of plans for small producers, development of road networks for forest product transport, forest health, fire management,

⁴ Provincial Forest Plan Neuquén 1999-2006. Available at: http://copade.neuquen.gov.ar/intranet/files/documentos/Produccion_sustentable/7.pdf

fire protection, investments for the development of the forest industry, land use and promotion of wood for building houses.

The Municipality of Aluminé is the state administrative center of the City, permanent residential location and supply center for primary and secondary services. The administrative offices of the CIP [Corporación Interstadual Pulmarí] are therein located. The main population settlement was planned by the provincial government as a tourist village for second homes throughout the northern shore of the Aluminé Lake, in order to encourage controlled land supply in the region.

There is a deficit in the management of plantations due to the lack of capital for pruning and thinning activities. Whereas there are several sources for funding, as it appears from Law 25,080 on the promotion of forest plantations, or Provincial Law 2,482 in terms of promoting plantations, pruning and thinning, in many cases these incentives result insufficient, because the financial resources are not available when the producer needs them, therefore resulting in the self-financing of the producer; or in other cases the amounts received are lower than those required by the work to be performed. This situation is much more serious when it involves medium or small forest producers.

In terms of service offering, there are few forestry workers, poorly trained to perform the required activities. A 75% of the total forested hectares in Aluminé, is included in the stage where the thinning activities are essential to achieve a healthy forest at final cut stage, and with a relevant valuable wood volume, in terms of quantity and quality.

In connection to products resulting from management activities, the main issue that arises is the insufficient demand for these products, fact that directly impacts the decisions of producers. Therefore, as producers have no clear sales target, they opt to carry out no activities involving costs which they are not sure will be covered. The same situation occurs when the final cut should be performed on plantations. As a consequence, producers show lack of motivation to forest new areas.

In addition, the failure in the appropriate management of the forest vegetation has a direct impact on the quality of wood, which shows a significant amount of knots, unsuitable diameter classes, presence of pests and diseases, thus affecting commercialization.

Issues concerning the Mapuches communities and forestation

Eight communities live in Aluminé: Norquinco, Currumil, Lefiman, Aigo, Wiñoy Tayiñ, Hiengueihual, Catalan and Puel.

In general, the Mapuches communities consider forestry as a threat, since the introduction of exotic species changes, according to Mapuches'

beliefs, the balance of the ecosystem. Moreover, it also hampers the normal development of their traditional farming-related activities.

Many communities accept the fact that forest plantations are established in the region, often within the communities, and therefore, they seek to reconcile this exogenous activity with the work developed by them, especially considering the significant migration of young people to the center of Aluminé, in search of working opportunities.

Skilled labor for forestry activities is scarce. The experience of communities in forest use is limited to the use of dead wood, either as logs, posts, firewood and reeds procurement.

There exists background information related to the creation of a forest crew in the Currumil community, which was in charge of performing forest management, and providing pruning and thinning services to third parties in the community, with the possibility of producing a direct benefit for the community members through the income earned.

However: "...own social policies implemented throughout the last decades by the Neuquén provincial government, seek to "territorialize" the indigenous population through various programs. This fact has been worsened for more than a decade due to the rising unemployment and/or precarious working conditions in wage employment, situation that caused a significant flow of the indigenous population from rural to urban areas in past decades. This 'territorialization' and revaluation process of identities and ethnicities, with increasing demands from this indigenous population, seek to create a growing confrontation with forestry activities, thus redefining the relations against this exploitation (of high importance in the analyzed region)."⁵

Industrialization of products

Abra Ancha sawmill, established in Aluminé, is the only sawmill intended for coniferous processing throughout the center area of the province.

There is another small-scale production sawmill, which uses poplar wood as input during summer season, and there are a couple of small-scale portable sawmills, which process poplars wood.

5 Stecher, Gabriel and Sebastián Valverde. Los proyectos de desarrollo rural y forestal en contextos de pluriculturalidad. Las comunidades indígenas en la jurisdicción de la "Corporación Interestadual Pulmarí", [Projects of Rural and Forest Development in multicultural contexts. Indigenous communities in the jurisdiction of "Corporación Interestadual Pulmarí"]. Province of Neuquén, Argentina. In: NTERAÇÕES, Campo Grande, v. 13, n. 2, p. 169-180, jul./dez. 2012.

In connection to the Abra Ancha sawmill, an investment process started in 2010 resulted in the extension of the warehouse, and the addition of a new sawmill line of Brazilian industry (2011), designed with the aim of processing logs from the first thinning of conifers. Thus, the demand for wood to third parties increased, pulling the different links in the forest industrial chain.

Whereas, raw material from native forest has been used in the activity during the early stages, in recent seasons own forest product began to be industrialized with the purpose of obtaining most profitable products in the timber market.

Current processing accounts for 350,000 p2/month to 390,000 p2/month, in an eight-hour shift and using an average of 1,700 m³ per month.

The products obtained are planks and blocks for pallets, sold as green wood and sent to the Valley area for the assembling of fruit bins. Planks are used to produce tongue and groove boards, and braces, dried in the Industrial Park of Junín de los Andes, about 100 km away. As Abra Ancha sawmill has no drying facilities, this transportation increases costs. Wood drying allows offering higher value products.

Other products manufactured in Abra Ancha are wooden blocks used for construction works, as developed through the building system of embedded blocks (BME, for its acronym in Spanish) used by Corfone. The houses and camping cabins built by the Choroi Lake is an example of this kind of works.

As a result of the new facilities, the higher volume of processed wood gave rise to an increase of lingo-cellulosic waste (woodchips and sawdust). This waste, resulting from the industrial process, has no specific destination and is collected in the nearby property, causing significant environmental drawbacks.

If the sawmill production is estimated in a range of 1000 -1400 m³/month, waste generation would be about 1780-2500 tons. per month. This issue should be solved in the short or medium term. Furthermore, the energy project contemplates the use of forest waste as branches and trims which are not usually used and represent a significant fire risk.

Another problem to be considered for the normal sawmill operation is the precarious quality of the electric supply and the restrictions to comply with the increased demand. Electric supply in the Aluminé area is not sufficient to cover the potential demand of Abra Ancha Plant, together with the population demand, especially during the peak tourist season.

Power and Energy Supply. Pros and Cons

This section which constitutes the subject matter of the project focuses on the main Positive Impacts of biomass use, pointing out a number of converging aspects:

- **Macro perspective:** The Kyoto Protocol has given this type of undertaking the nature of 0 balance in terms of CO₂ emissions, taking into account that said emissions would equally occur due to the natural decomposition of biomass; however, they produce no additional benefit, provided that the maintenance of soil quality, which could be affected by a partial removal of waste from the forest, is ensured
- **Replacement of fossil fuels:** Given that the energy matrix of Argentina is mainly made up of natural gas and oil-related products, its use is limited in terms of the energy production of the new plant, or it replaces new undertakings with such energy base. In the specific case of Aluminé, the current power supply system, due to the low quality of its product and service, has been locally complemented with two diesel power generators installed in Aluminé. This situation should be considered as an additional local benefit, given that polluting emissions coming from these units could be avoided.
- **Improved service and product quality in the area of influence:** According to electrical studies made, based on EPEN [for its acronym in Spanish for Provincial Energy Agency of Neuquén] information, the Aluminé node is Electricity Importer, even assuming the whole operation of its thermal and hydraulic infrastructure. This fact makes the area sensitive and dependent on the reliability of the connection to the Zapala node. The incorporation of the new plant would transform the Aluminé node into an energy exporter, thus improving the regional system.
- **Response to further energy own demands:** The new sawmill production lines comprise an installed capacity of approximately 400 kW, with an actual demand of 250 kW. Furthermore, the wood drying process using steam, extracted from the power generator turbine, could be included in the future. This process would constitute an efficient electricity-steam co-generation system.
- **Economic benefit:** The feasibility study showed the benefits of the project from the economic and financial viewpoints.
- **Generation of direct and indirect jobs:** Job positions will be created during construction, as well as direct jobs required by the plant operation and the system of transformation and transport of energy, management of biomass for energy use, labor and equipment required by technical and logistic services.

- **Improvements to current working operations and risk reduction:** The new equipment required provides improvement in the operation and reduction in fire risk due to the removal of waste from the forest.

In addition, the facilities required for energy transformation and transport during the operation process and maintenance of the system, are not free from negative impacts to be removed, cleared or mitigated:

- **Electric and magnetic fields:** While medium voltage lines do not generate high intensity fields, rules on safety distances and prevention of risks and limitations on other infrastructure must be complied with.
- **Restrictions on land use:** Conditions stated within the right-of-ways areas shall be observed, and right-of-ways for maintenance purposes or contingencies shall be ensured.
- **Impact on flora and fauna:** Impact on flora and fauna is reflected on a reduced scale in the maintenance operations of right-of-ways areas, due to cleaning or selective pruning requirements. Regarding the fauna, main impacts are observed in birds, due to the risk of impact with conductors or by electrocution; the latter will depend on the geometry adopted for the laying of conductors (maximum distances among conductors represent minimum electrical risk).
- **Impact on the Socioeconomic Activity:** Already in the construction phase, visual impact, and some inconveniences to the farming activity are observed due to the restrictions imposed by the right-of-ways areas. Road system obstructions may further be considered in case of contingencies, or the eventual transport of biomass from other sources.
- **Contingency Risks:** Main contingencies are related to fire, unscheduled plant shutdowns, service exits from the transmission line due to technical, climatic or accident-related reasons.

Conclusion

In general, forest biomass can be used for energy production, as well as other organic resources with a positive environmental impact and high energy use. "It is important to emphasize that the potential use of biomass energy in Argentina is greater than its current use. In this sense, and for its future development, it results necessary to perform an important diffusion of the existing opportunities and available using technologies."⁶ Furthermore, it is a renewable resource, whose use contributes to the environmental conservation, allowing:

- The development of energies in line with the environment
- The reduction of greenhouse gases emissions

⁶ Pinasco, Horacio *"Generation of Energy with forest waste and crop"*. Available at: <http://inta.gob.ar/>

- The development of the regional and national industry

In the specific case of this project, the following actions, covering the industrial and productive process, are proposed and may be further translated into public policies, promoting social and environmental development of the region. These actions are as follows:

Sustainable management of the forest (associated with the primary production)

With regards to the primary production sector, this project aims to improve the quality of the wood produced in Aluminé, through a sustainable management of plantations. In this sense, it is important to increase the number of producers carrying out the necessary forestry work, thus improving production. The activities consist in performing a timely pruning, thinning, application of herbicides, pest and disease controls.

Moreover, the project will promote the creation and technical training of crews for pruning and thinning activities. Said crew will be able to provide services to third parties, causing a direct impact on the increase of job positions, as higher labor would result necessary.

Technical assistance and training to beneficiaries will be also provided, as well as the necessary tools for the development of productive activities. In this sense, consulting services may be hired for the drawing of a sustainable forest management plan in the project area, allowing the solution of incorrect operation issues, due to the lack of technical knowledge.

In terms of the Mapuches communities that live in places where there are forest plantations, the project will aim to make a proper forest-gazing management, so that they can further develop their farming activities according to a scheme whose main focus will be the sustainable development of resources.

Construction of a Biomass plant of power generation from biomass waste, with the installation of a dryer in the sawmill and the incorporation of an additional production line

As a result of the set up of the plant and ancillary facilities, a greater demand for wood will be produced, increasing the purchases made by CORFONE to third parties. This fact would generate an increased processing capacity, rising from 390,000 p2/month to 600,000 p2/month, and will encourage producers to properly manage their plantations in order to deliver quality wood in a timely manner.

The construction of the plant will also make possible to solve the lignocellulosic waste accumulation, giving solution to the environmental problem.

The processing facilities of residual biomass will make available steam which could feed the drying chambers in Abra Ancha. The set up of drying chambers will avoid the disadvantage of transporting wet boards, and would also increase the production value without additional energy cost.

The plant operation will allow the production of electric energy which will ensure energy supply to the plant and the sawmill facilities, reducing restrictions in terms of power, frequency duration and current cuts. Surplus may be further delivered to the public electric system.

Therefore, it can be assumed then that the implementation of the project will achieve among others, the following important effects: the replacement of fossil fuels with residual biomass, resulting from wood processing; the improvement of the availability and quality of the electric supply in the area of influence; the reduction of fire risks through the partial reuse of scattered waste produced by forest exploitation, and the solution to the environmental threat caused by the accumulation of forest industrial waste at the plant. Another effect to be included is the additional direct and indirect labor demand, as well as the production of additional economic resources associated to the profitability of this undertaking.

References:

J. Arauzo et al. "Introducción a las tecnologías de aprovechamiento de biomasa" [Introduction to Biomass Use Technologies] Available at: www.gecarbon.org/listnl.asp.

Law 26.190 Regimen de Fomento Nacional para el uso de fuentes renovables de energía destinada a la producción de energía eléctrica [National Programme for the Promotion of the Use of Renewable Sources of Energy Destined for Electric Power Generation]. Purpose. Scope. Application. Authority of Application. Policies. Investment Scheme. Beneficiaries. Benefits. Approvals. Trust Fund for Renewable Energy. Passed on December 6, 2006. Enacted on December 27, 2006. Ministry of Economy and Public Finances of the Argentina Republic. Available at: <http://infoleg.mecon.gov.ar/infolegInternet/anexos/120000-124999/123565/norma.htm>.

Pinasco, Horacio "Generación de Energía con cultivos y residuos forestales" [Energy Generation with crop and forest waste]. Available at: <http://inta.gob.ar/>

Forest Provincial Plan Neuquén 1999-2006. Available at: http://copade.neuquen.gov.ar/intranet/files/documentos/Produccion_sustentable/7.pdf

Stecher, Gabriel and Sebastián Valverde. Los proyectos de desarrollo rural y forestal en contextos de pluriculturalidad. Las comunidades indígenas en la jurisdicción de la "Corporación Interestadual Pulmarf", [Projects of rural and

forest development in multicultural contexts. Indigenous communities in the jurisdiction of “Corporación Interstadual Pulmarí”]. Province of Neuquén, Argentina. In: NTERAÇÕES, Campo Grande, v. 13, n. 2, p. 169-180, jul./dez. 2012.

FREEDOM OF INFORMATION AND THE RIGHT TO ENVIRONMENTAL PROTECTION

Ana Cristina Carvalho, PhD

Centre for International Governance Innovation, Canada

Abstract

Freedom of information is essential to exercise the right to environmental protection, which belongs to all people in the world and deserves a special attention as they will not be able to exercise it without access to environmental information. The United Nations Human Rights Council adopted a resolution on human rights and climate change, which calls for increased international dialogue on the adverse impacts of climate change with an emphasis on those States with the greatest need of assistance from the international community. However, the effective environmental protection is only possible through the active participation of the public, so citizens should be enabled to take their own responsibility for the environment more seriously. In this sense, the Aarhus Convention stipulates important rights for the participation of citizens in environmental protection and establishes a number of rights of the public (individuals and their associations) with regard to the environment. This paper aims to analyze whether international law can help to promote the access to environmental information in an efficient way. The adopted methodology comprehends a deductive approach and techniques of qualitative, theoretical, explanatory and bibliographic research, by consulting books, websites, journal articles, news and official documents. The results show a critical view of the current rules and propose suggestions on how the issue of access to environmental information should be addressed in order to benefit the whole international community by promoting access to world's environmental information.

Keywords: Freedom of information, Environmental Protection, International law

Introduction

The value of the information increases every day and it is essential to exercise the right to the environmental protection, so international law plays a very important role to help implement freedom of information.

Although the internet represents a revolutionary method for people to interact, informing and being informed, it is essential that governments use this tool appropriately.

This work seeks to discuss how international law can help promote freedom of information towards the exercise of environmental protection in an efficient way and the adopted methodology comprehends a deductive approach and techniques of qualitative, theoretical, explanatory and bibliographic research, by consulting books, websites, journal articles, news and official documents.

Freedom of Information and International Law

In 1946, the United Nations (UN) General Assembly adopted the expression 'Freedom of Information (FOI)' in its Resolution 59 (UN, 1946) meaning the right to gather, transmit and publish news anywhere and everywhere without fetters. FOI was then recognized as a fundamental human right and as the touchstone of all the freedoms to which the United Nations is consecrated.

Brazil held the UN Conference on Environment and Development in 1992, most known as 'Rio 92', which led to Rio Declaration on Environment and Development. Its Principle 10 heralds that each individual shall have appropriate access to information concerning the environment that is held by public authorities at the national level, including information on hazardous materials and activities in their communities (UNEP, 1992).

Environmental information was first defined by the Aarhus Convention (UNECE, 1998) as any information in written, visual, aural, electronic or any other material form on:

(a) the state of elements of the environment, such as air and atmosphere, water, soil, land, landscape and natural sites, biological diversity and its components, including genetically modified organisms, and the interaction among these elements;

(b) factors, such as substances, energy, noise and radiation, and activities or measures, including administrative measures, environmental agreements, policies, legislation, plans and programmes, affecting or likely to affect the elements of the environment within the scope of subparagraph (a) above, and cost-benefit and other economic analyses and assumptions used in environmental decision-making;

(c) The state of human health and safety, conditions of human like, cultural sites and built structures, inasmuch as they are or may be affected by the state of the elements of the environment or, through these elements, by the factors, activities or measures referred to in subparagraph (b) above”.

The UN General Assembly keeps discussing access to environmental information and approving new Resolutions, but they are basically

recommendations. Rio Declaration Principle 10 demands rules within domestic legal orders, while the Aarhus Convention did state the right of access to environmental information. However, it has only 47 Parties (46 countries and the European Union). So, regardless of the international effort to spread the access to environmental information, this issue still depends a lot on domestic policies.

Transparency: Information Request *versus* Open Data

Due to the fact that environmental information is not personal, but a kind of public information, providing access to environmental information requires the information to be published, which relates to transparency, a word whose meaning denotes two necessary and jointly sufficient conditions: the visibility of information, and its inferability – the ability to draw accurate conclusions from it (Michener & Bersch, 2013).

When it comes to visibility of information, open data came to life in 2009 when several governments announced initiatives to provide greater public access to government data sets, which went beyond the data contained in official publications or releases of summary datasets to providing unrestricted access to administrative records and unit record data, limited only by the necessary precautions to preserve anonymity where confidentiality had been promised as a condition of data collection (Belkindas & Swanson, 2014).

Open data is data that can be freely used, re-used and redistributed by anyone – subject only, at most, to the requirement to attribute and share alike. This definition comprehends:

- “Availability and Access: the data must be available as a whole and at no more than a reasonable reproduction cost, preferably by downloading over the internet. The data must also be available in a convenient and modifiable form;
- Re-use and Redistribution: the data must be provided under terms that permit re-use and redistribution including the intermixing with other datasets;
- Universal Participation: everyone must be able to use, re-use and redistribute - there should be no discrimination against fields of endeavour or against persons or groups. For example, ‘non-commercial’ restrictions that would prevent ‘commercial’ use, or restrictions of use for certain purposes (e.g. only in education), are not allowed” (Open Knowledge, n.d.).

The adoption of the open data concept through a proactive disclosure is the most transparent way to spread environmental information because it eliminates the need of a request by the citizens, which can take a long time to be attended. It is true that many countries do have national rules on access to information, but when it comes to environmental information it is

essential to have open information by means that data should be available independently of a request.

On the other hand, the inferability of information implies that people will be able to understand the data's meaning, so that the set of characters can turn into knowledge. Data, information and knowledge have different concepts in the universal domain: "data are sets of signs that represent empirical stimuli or perceptions, information is a set of signs which represent empirical knowledge, and knowledge is a set of signs that represent the meaning (or the content) of thoughts that the individual justifiably believes that they are true" (Zins, 2007, p. 487). So, just publishing data is not enough also: it is important to show the information in a way people will be able to understand.

The North American Agreement on Environmental Cooperation (Commission for Environmental Cooperation, 1993) could also provide a useful example: under its Articles 14 and 15, citizens and non-government organizations can raise claims, known as citizen submissions, against the Parties to the agreement alleging that a Party is failing to effectively enforce its environmental law. Goldschmidt (2002, p. 345) recognizes the citizen submissions as an example of transparency and public participation in international environmental agreements.

It is also important to point out that the role of freedom of information laws should not be resumed to access to information and participation, as human activities often have led to unforeseen impacts on the environment, and once environmental damages occur, the cost for environmental restoration may be extraordinarily high. This is why the environmental impact assessment (EIA) procedure is required to be carried out before any action that may have an impact on the environment is initiated. In the course of EIA, information on possible risks is collected and disclosed to the public concerned (Morishima, 2007, p. 194).

The right to environmental protection belongs to people from all over the world and the language in which the information is published can also make hard for them to access it and be aware of the risks we are facing regarding climate change. In this sense, international organizations such as Article 19, Avaaz and Greenpeace play such an important role by helping people to understand the gravity of the problems we are facing nowadays, as well as encouraging them to participate on a number of discussions and requests.

Conclusion

The freedom of information has long been recognized, since the Resolution 59 adopted by the UN General Assembly in 1946. However, the concern with environmental information has considerably increased after

Principle 10 of the Rio Declaration on Environment and Development in 1992. In 1998, the Aarhus Declaration established the right of access to environmental information.

A number of countries have domestic laws on access to information that apply to environmental information, but these rules could yet be improved in order to promote open data, so that citizens do not depend on information requests to be aware of the environmental scenario. Also, the correct comprehension of the rules requires the availability of efficient tools to help people interpret them, and international organizations play a very important role in this sense.

Also, the countries should adopt the necessary measures in order to eliminate bureaucracy and improve Open Government as a way to fight climate change together with citizens.

References:

- Belkindas, Misha, and Eric Swanson. (2014). "International support for data openness and transparency". *Statistical Journal of the IAOS* 30 (2014) 109-112.
- Carvalho, Ana. (2014). *Marco Civil da Internet no Brasil – Análise da Lei nº 12.965/14 e do Direito de Informacao*. Sao Paulo: Alta Books, 2014.
- Commission for Environmental Cooperation. (1993). *North American Agreement On Environmental Cooperation*. Retrieved from <http://www.cec.org/Page.asp?PageID=1226&SiteNodeID=567>
- Goldschmidt, Mark. (2002). "The Role of Transparency and Public Participation in International Environmental Agreements: The North American Agreement on Environmental Cooperation" *Boston College Environmental Affairs Law Review*, Vol. 29 (2002) 343-307.
- IPCC. (2014). *Climate Change 2014 Synthesis Report – Summary for Policymakers*. Retrieved from https://www.ipcc.ch/pdf/assessment-report/ar5/syr/AR5_SYR_FINAL_SPM.pdf
- Michener, Greg, and Katherine Bersch. (2013). "Identifying Transparency" *Information Policy* 18 (2013) 233-242.
- Morishima, Akio. (2007) "Environmental Information in the Law" *Environmental Policy and Law*, 37/2-3 (2007) 194-195.
- Open Knowledge. (n.d.). *Open Data Handbook*. Retrieved from <http://opendatahandbook.org/>
- UN. (1946). *Calling of an International Conference on Freedom of Information*. Resolution 59, 14 December 1946. Retrieved from <http://daccess-dds-ny.un.org/doc/RESOLUTION/GEN/NR0/033/10/IMG/NR003310.pdf?OpenElement>

- UN. (2012). The future we want. Resolution of the General Assembly A/RES/66/288. 27 July 2012. Retrieved from http://www.un.org/ga/search/view_doc.asp?symbol=A/RES/66/288&Lang=E
- UN. (2012). Resolution adopted by the General Assembly on 21 December 2012. A/RES/67/2013. Retrieved from http://www.un.org/en/ga/search/view_doc.asp?symbol=A/RES/67/213
- UN. (2013). Resolution adopted by the General Assembly on 18 December 2013. A/RES/68/167. Retrieved from http://www.un.org/en/ga/search/view_doc.asp?symbol=A/RES/68/167
- UNECE. (1998). Convention on Access to Information, Public Participation in Decision-Making and Access to Justice in Environmental Matters. Retrieved from <http://www.unece.org/fileadmin/DAM/env/pp/documents/cep43e.pdf>
- UNECE. (2015). Report of the Task Force on Access to Information on its third meeting. ECE/MP.PP/WG.1/2015/3. Retrieved from http://www.unece.org/fileadmin/DAM/env/pp/wgp/WGP_19/ECE_MP_PP_WG.1.2015.3.eng.pdf
- UNEP. (1992). Rio Declaration on Environment and Development. Retrieved from <http://www.unep.org/Documents.Multilingual/Default.asp?DocumentID=78&ArticleID=1163>
- UNEP. (2014). United Nations Environment Programme access-to-information policy. Retrieved from <http://www.unep.org/environmental-governance/Portals/8/documents/UNEP-access-to-information-policy.pdf>
- UNEP. (2015). UNEP Access-to-Information Policy. Retrieved from <http://www.unep.org/environmental-governance/UNEPsWork/policy/tabid/794452/Default.aspx#comments>
- UNESCO. (n.d.). Freedom of Information. Retrieved from <http://www.unesco.org/new/en/communication-and-information/freedom-of-expression/freedom-of-information/>
- Yale University and Columbia University. (2010). 2010 Environmental Performance Index. Retrieved from http://epi.yale.edu/files/2010_epi_summary_for_policymakers.pdf
- Zins, Chaim. (2007). "Conceptual Approaches for Defining Data, Information and Knowledge" *Journal of the American Society for Information Science and Technology*, 58 (4): 479-493. Retrieved from http://www.success.co.il/is/zins_definitions_dik.pdf

MODELING OF HYDROLOGICAL AND ENVIRONMENTAL PROCESSES THROUGH OPENMI AND WEB SERVICES

Konstantinos Kokkinos' PhD

Department of Computer Science and Engineering,
Technological Education Institute, Larissa, Greece

Department of Civil Engineering, University of Thessaly, Volos, Greece

Nicholas Samaras, PhD

Department of Computer Science and Engineering,
Technological Education Institute, Larissa, Greece

Chrysi Laspidou, PhD

Athanasios Loukas, PhD

Department of Civil Engineering, University of Thessaly, Volos, Greece

Abstract

Integrated collaborative modeling has been proven lately to be the most accurate computer methodology that allows modelers to scrutinize the environmental processes using a holistic approach. Due to the dynamic and interdependent nature, such processes involve the interlinking of hydrological, meteorological, environmental, ecosystems and socio-economical characteristics. In this paper we deal with the development and the integration of a collaborative system of models devoted to the water quantity and quality monitoring, and also to the management of water resources in a watershed. The system is also tailored by a socio-economical study that highlights the impact of the aforementioned management to the local community of the region under study. Models that integrate the collaborative system need to be coupled so that to run simultaneously under the spatial and temporal synchronization condition. To achieve such a simultaneous synchronization, the Open Modeling Interface, (OpenMI) is invoked. The system has been applied and tested to the Lake Karla watershed in Thessaly region, Greece. However due to the loose integration methodology used for its development and to its open ended property, the system can be easily parametrized to offer such an analysis on other similar case studies. An extension to the OpenMI standard provides the remote simultaneous run of models using web services and allowing the development of a cloud repository of models for future use.

Keywords: Water resources management, web, services, coupling, OpenMI

Introduction

Research dealing with the simulation and the monitoring of complex interdependent environmental processes is mostly inspired by a cascading methodology that simulates each phenomenon in sequential fashion aggregating the individual outcomes into a collection of general results. This research methodology attempts to produce integrated and collaborative environmental software frameworks that focus in three distinct aspects as to how they see the use and the functionality of these frameworks (Laniak et al., 2013): (a) stakeholder involvement, (b) adaptable functionality of the decision process and (c) reuse of the framework for various case studies and scenarios. On the opposite site lately, there is a considerable amount of research that prioritizes the holistic thinking and assessment of water management problems. According to this approach, the interest in the development of an integrated modeling framework shifts towards the knowledge unification of different heterogeneous domains into a coherent and user friendly representation (Kragt et al., 2011; Otto-Banaszak et al., 2011). Advocates of this methodology argue in terms of creating a standardization procedure of model interlinking and coupling for integrated modeling. Two major methodologies are proposed: (a) the Consortium of Universities for the Advancement of Hydrologic Science, Inc. (CUAHSI) Hydrologic Information System (HIS) (Maidment, 2008; Tarboton et al., 2009) and (b) the Open Modeling Interface (OpenMI) (OpenMI, 2015). Both attempt to facilitate model coupling. OpenMI additionally provides a reference Software Development Kit (SDK) for a standard implementation. Because the two systems were developed by independent groups, there is no formal mechanism for using both the HIS and the OpenMI collectively. However, the systems share important similarities that make interoperability possible (Castronova et al., 2013).

This study attempts to interlink the criteria set by (Laniak et al., 2013) with the coupling functionalities promoted by the holistic approach and thus, provides a new roadmap in water resource integrated modeling. More specifically, we propose a set of milestones that need to be achieved in order to capture all the idiosyncrasies of the hydrological phenomena under study, the optimization of the conceptual models that simulate these phenomena and the interlinking of the models in a holistic simulation paradigm (Kokkinos et al, 2014):

- Documentation of the best practices and development guidelines for the system conceptualization, quantitative modeling methodology, and synthesis of the modeling results.

- Development of rigorous methods for data exchange among components of collaborative systems that resolve dimensional conflicts (e.g. space and time aggregations, socio-economics, chemicals etc.).
- Development of standardization process in metadata annotations and description semantics.
- Development of a conceptual framework dedicated for comprehensive analysis in integrated modeling systems and,
- Provision of spatial and temporal synchronization of the participating models in an open-ended architecture that allows the inclusion of further models and the generalization of the analysis independently of the case study.

In this work, a collaborative environmental modeling prototype is presented which is based on the loose integration paradigm. According to this technique, several participating models can individually or simultaneously simulate the surface and groundwater hydrology processes in a watershed as well as the lake water balance and the development of cyanobacteria in it. Simulation time steps of running the aforementioned models may vary and the produced time series may result in values of various units. However, when models need to collaborate with unidirectional or bidirectional linking and time series interchanging is necessary, we involve the OpenMI technology that has the ability to invoke the simultaneous runs of the models taking care of their spatial and temporal differences. This feature provides a flexible operational environment both for the stakeholders and the researchers. Additional features include a visualization component of the time series produced, an integrated database repository of all input and output data and the ability to append this database in adding new model data using a converter to modify these data based on the “*any model to OpenMI*” functionality. For models that carry code of proprietary nature that does not allow the implementation of OpenMI-wrappers to apply the coupling process, a semi-automatic methodology is used which is based on the background data interchanging directly from the stored input and output files of the models.

In this paper we develop an integrated monitoring and simulation software framework (monitoring and modeling system) to assess the hydrological, environmental, ecological and socio-economic dynamics in lakes basins or wetlands and to manage their water resources. This framework consists of a series of interconnected (or coupled) models and even though it has been developed as a general tool for any basin, in this paper we show its implementation for the recently restored Lake Karla in Thessaly, Greece. We aim in the creation of a decision support system able to help towards more efficient use of water resources and thus protect the environment. Furthermore, the creation of such research and experimentation

tool (test bed) can be a quick and easy tool for hydrologists, environmentalists and other scientists for taking measurements concerning specific characteristics of wetlands. The following sections of this paper, illustrate the details of this logical software architecture. We first present the case study of the monitored watershed and justify the characteristics of our approach. We then provide a schematic and verbal illustration of the logical modeling architecture and the overall simulation framework implemented. Following is the presentation of the participated models. At the end of the paper we discuss the specifics of the model coupling using the OpenMI standard. We also show the development of a web application to link models based on this standard. This allows modelers to remotely use models of other modelers and couple them through this user friendly environment. All these functionalities mentioned above make this operational environment integrated and productive in assessing water resources in a watershed.

The Lake Karla, Thessaly, Greece case study

Thessaly is a region in central Greece which faces the most prominent example of today's water resources over-exploitation problem due to the fact that the area is intensely cultivated. The available surface water resources of the region, correspondent to the Pinios River, are not sufficient to meet the needs of the extensive agriculture of water demanding crops (cotton, maize, etc.). This situation has led to a remarkable increase in water demand, which is usually fulfilled by the over-exploitation of groundwater providing an irrational pattern of groundwater that result in a gradual deterioration of the already disturbed water balance and the acceleration of water resources degradation.

Apart from the problems that the overall region has, the watershed of Lake Karla faced various human interventions over the years. Up until the 1960's the lake area fluctuated from 40 to 180 km² due to the very gentle land slope and the inflow-outflow balance thus; a large part of the surrounding farmland was often inundated facing soil salinity problems. Karla was converted to agricultural land in order to protect Thessaly from flooding, to extend the farming area to the poor farmers and to minimize the malaria problem, but the results of that conversion were much more complex. Some of those results were: change of the area microclimate, reduction of the aquifer water level, introduction of sea water in the aquifer, lack of drinking and irrigation water, common flooding of the farmed areas, pollution of the adjacent gulf, loss of an important habitat for endangered European birds, as well as overall reduction in the number of farmers in the area (Gerakis and Koutrakis, 1996). In many cases, official authorities' interventions that converted wetlands into agricultural land caused an unexpected effect: the people that were supposed to benefit from this

conversion - the farmers - were the first ones that eventually suffered the negative consequences of it. Figure 1 depicts the broader area of Thessaly and the borders of the watershed under study.

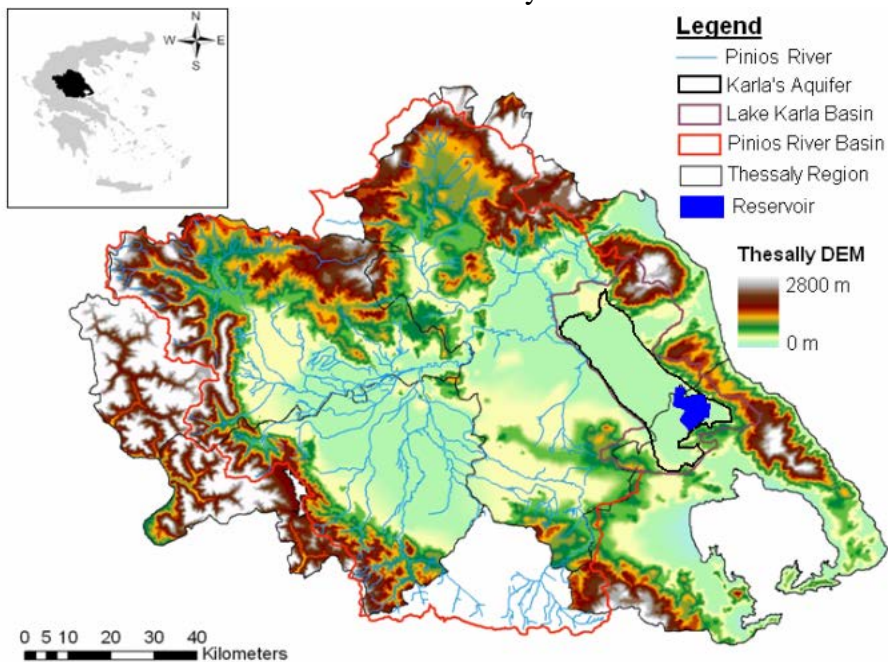

Fig.1 The field of study of the Lake Karla Basin in relevant scale to the Thessaly region.

The government decided to restore the lake with the construction of a reservoir, which started to operate in December of 2010. A historical overview of the environmental policies that lead to the drainage of the lake is presented in (Laspidou and Gialis, 2014). For the above reasons, the competent authorities continuously promote the development of an integrated monitoring system that evaluates the surface and groundwater water resources, observes the nutrient flows' dynamics in the reservoir, analyzes the important natural ecosystem under restoration behaviour and tries to draw conclusions on the socio-economics' impacts of the above to the local community.

Logical Architecture of the Modelling Integrated Framework

The proposed system consists of a collection of numerical and conceptual hydrological and environmental models for the simulation of surface and groundwater hydrology, lake balance, ecosystem and socio-economic conditions affecting the dynamics of the physical processes.

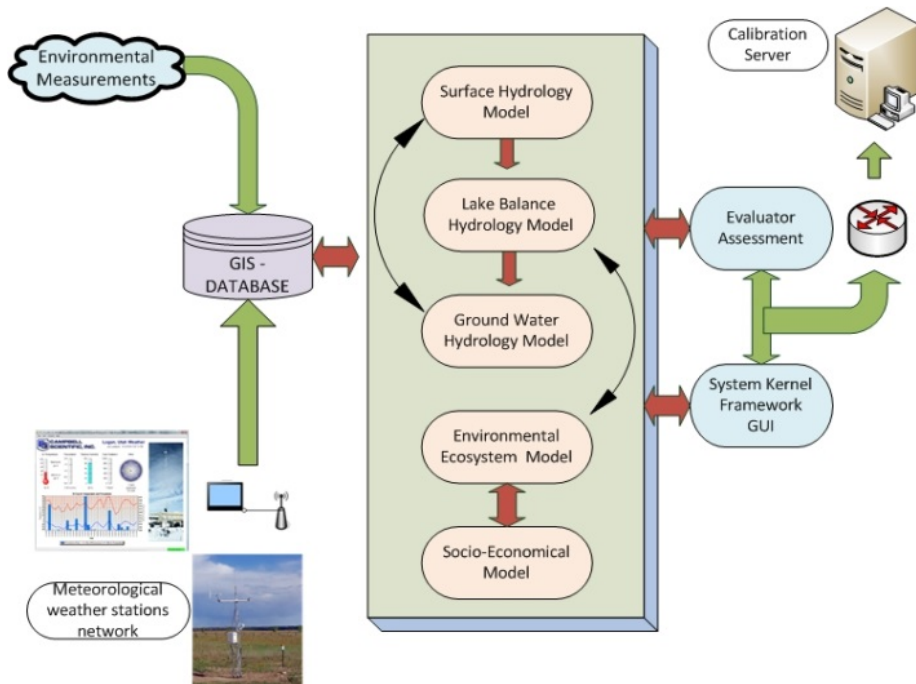

Fig. 2 The architecture of the collaborative modelling framework.

The participating models are: (a) a surface hydrology model, (b) a lake/reservoir water balance and operation model, (c) a groundwater hydrology model, (d) an environmental ecosystem model and (e) a socio-economic model. Data are aggregated from various sources into a GIS-database that captures both the spatial and temporal characteristics of the model input variables. Observations of meteorological data coming from meteorological stations set in the area as well as satellite remote sensing data are put into the database. Environmental data are gathered on a monthly basis to determine the occurrence and production of *Microcystis Aeruginosa* cyanobacteria development in a reconstructed lake environment. A full-scale monitoring study of *Microcystis Aeruginosa* and relevant environmental, hydro-meteorological factors and water quality parameters are also conducted in the restored lake Karla. Nutrient fluxes from and into lake sediment are measured, assessing the role of lake sediment as source or sink of nutrients. All these time series data are included in the database and are updated on an appropriate time step basis.

The system is equipped with a model calibration server, where the user may calibrate the surface hydrology and the lake water balance models using a variety of input data lengths. The primary calibration and optimization method used is the Generalized non-linear Reduced Gradient (GRG2), however, the system provides the appropriate hooks for inclusion of additional techniques. The framework kernel allows the user through an

intuitive Graphic User Interface (GUI) to run individual models of the system or couple models into a simultaneous simulation. The coupling of models is designed according to the set of input and output exchange items needed by the models from other models to run. Models are coupled in a unidirectional manner for our case study due to specific hydrological processes monitored. However, bidirectional coupling can be included in a seamless way using the OpenMI Application Program Interface (API). The implementation of the coupling wrappers is accomplished using the OpenMI-SDK in Visual Studio C# programming language.

Description of participating models

Surface Hydrology

For monitoring the surface hydrology of the region, a monthly conceptual water balance model, called UTHBAL was developed and validated by (Loukas et al., 2003; Loukas et al., 2007). The model has been developed in lumped, semi-distributed and fully distributed spatial aggregations. The model uses as inputs the time series of precipitation, temperature and potential evapotranspiration and allocates the watershed runoff into three components, namely, the surface, the medium and the base flow runoff using a soil moisture mechanism. The actual evapotranspiration, the surface runoff, the soil moisture, the snowpack water equivalent and the groundwater recharge are the outputs with the last being the linking data to the groundwater model.

Lake-Reservoir Water Balance

The reservoir model is called UTHRL given in (Loukas et al., 2007). It's a conceptual model using the following equation to describe the operation of the reservoir in a monthly time step:

$$V(j) = V(j-1) + Q(j) - E(j) - A(j) - Y(j) \quad (1)$$

where $V(j)$ and $V(j-1)$ correspond to the stored water volumes in the reservoir on the months j and $j-1$ respectively, $Q(j)$ is the inflow to the reservoir on the month j , $E(j)$ is the net water loss from the reservoir for the month j , $A(j)$ is the real withdrawal for the month j , and $Y(j)$ is the real overflow during that month. The reservoir storage and overflow are calculated using (1). The monthly net water losses of the reservoir are estimated from the equation:

$$E(j) = E_o(j) - P_o(j) + L(j) + Q(j) \quad (2)$$

where, $E(j)$ are the net water losses of month j , $E_o(j)$ is the evaporation from the reservoir water surface of month j , $P_o(j)$ is the direct precipitation on the reservoir during month j , $L(j)$ are the estimated deep percolation losses to groundwater and $Q(j)$ is the natural surface runoff that

would have been generated from the area of the reservoir if the reservoir does not exist. The above quantities are expressed to volume units (hm^3). The water level and the surface area are estimated using the reservoir storage-water level and surface area-water level curves. Using these curves, an expression is developed relating the reservoir water surface area, F , to reservoir storage, V :

$$F = a + bV^c \quad (3)$$

where, a , b , c are estimated coefficients through curve fitting.

Groundwater Hydrology

The Groundwater MODFLOW System (GMS) modeling software is a commercial product of MODFLOW model used for the simulation of groundwater. MODFLOW is considered a worldwide standard model for groundwater simulation. MODFLOW is a modular finite-difference flow model that solves the groundwater flow partial differential equations using the values of hydraulic conductivity along all the coordinate axes, the potentiometric head, the specific storage of the porous material, the time and the volumetric flux per unit volume representing sources and/or sinks of water, where negative values are extractions and positive values are injections.

Environmental Ecosystem Model

The PCLake model calculates the water quality parameters chlorophyll a, transparency, phytoplankton types and the density of submerged macrophytes. It also calculates the distribution and fluxes of the nutrients N and P. Inputs to the model are: Lake hydrology, nutrient loading, dimensions (mean depth and size) and sediment characteristics. An extensive description of the model may be found in (Janse, 1996). The model describes a completely mixed water body and comprises both the water column and the upper sediment layer (Figure 3). In this figure, doubled blocks denote compartments modelled in both dry weight and nutrient units. Three functional groups of phytoplankton are distinguished: cyanobacteria, diatoms and other small edible algae. Arrows with solid lines denote mass fluxes (e.g. food relations), arrows with dotted lines denote 'empirical' relations (minus sign denotes negative influence, otherwise positive influence).

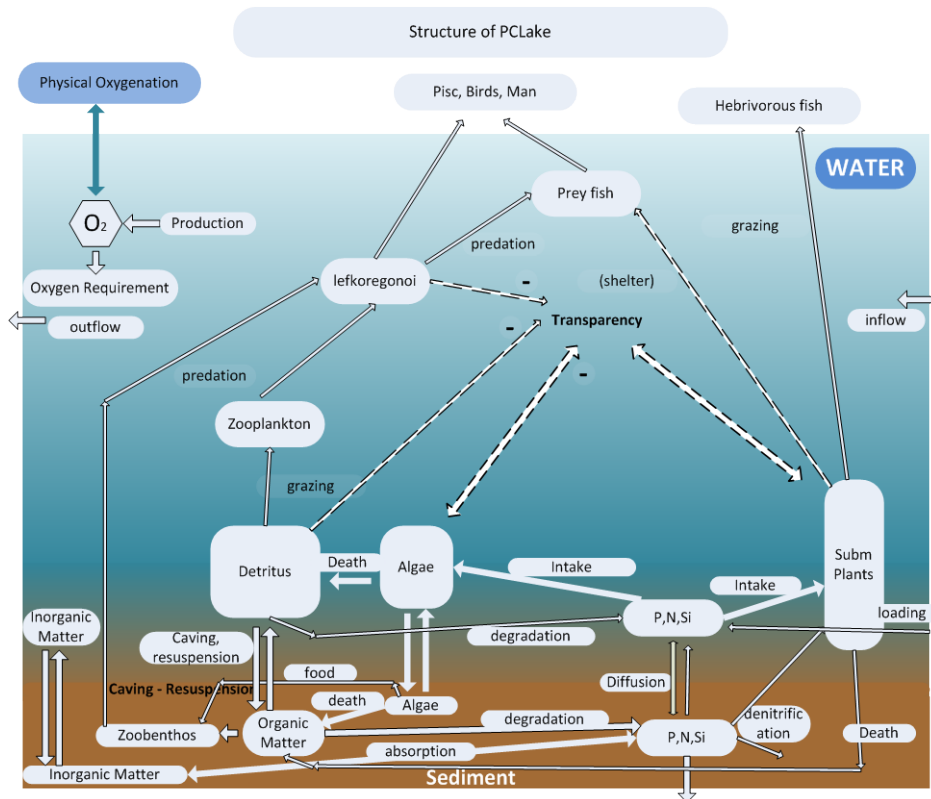

Fig. 3 The structure of the PCLake model. Courtesy of (Janse, 1997).

Socio-economics

The socio-economic model analyzes the relationships between the physical/natural system conditions, the human interventions to water environment and the relevant socio-economic procedures. More specifically the study tries to identify the impacts of the lake restoration to the social lives of the residents in the nearby regions of the lake. Factors that are important are the water irrigation costs and the environmental side effects caused by the lake restoration.

Model Coupling

Model coupling is achieved by migrating the computational engines of the models to the OpenMI-standard. This migration essentially enables the spatial and temporal synchronization of the participating models prior to their simultaneous run. In the possible scenario that the models cannot be migrated to the OpenMI standard due to the proprietary nature of their code then, a semi-automatic coupling methodology is implemented that reads and writes data directly to the relevant input and output files of the models. More specifically, all transformations of data are stored into xml-type files that

provide the properties as to the model type, the time step of the simulation, the geometry (cell-id, cell size), the entity and the value calculated. UTHBAL participates in two coupling processes. In the first, the basin surface runoff from UTHBAL is passed to UTHRL that balances the inflows and outflows of the reservoir in order to calculate the spillway overflow and the reservoir water storage. In the second, UTHBAL passes the calculated groundwater recharge to MODFLOW but with a semi-automatic way.

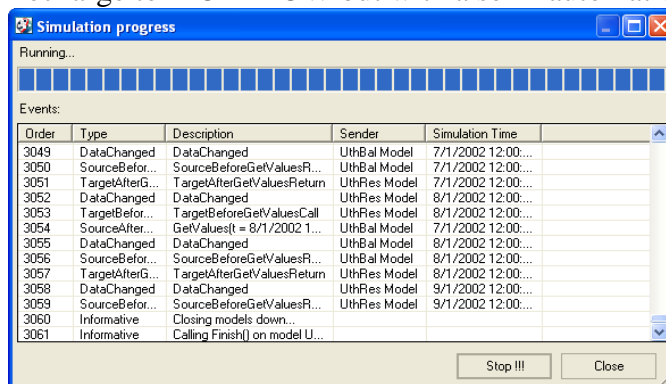

Fig. 4 Linking of UTHBAL and UTHRL models to run simultaneously.

Figure 4 depicts the process of the UTHBAL and UTHRL coupling in a simultaneous simulation using OpenMI. As shown, the user can easily inspect the passed values and the time horizon of the simulation. On the other side, MODFLOW uses the water inflow, the evaporation and the withdrawal quantities from UTHRL along with the calculated groundwater recharge from UTHBAL to create maps of the hydraulic heads and to calculate the volumetric budget of the aquifer. Finally, the aquifer volumetric budget is passed to the PCLake environmental software since the calculation of phytoplankton, macrophytes, sediments (suspended, active and deep), bottom detritus, phosphorus in the sediments and phosphorus in the water column are depended on the water volumetric budget of the aquifer.

Furthermore, we added the involvement of Web Services as a concept for integrating scientific models in this collaborative environment. However, this methodology is successful for environmental model coupling if and only, all participating models are modularized into self-containing geo-processing units (Granell et al., 2010). On the other hand, using such a web application, we can make operations available to end-users who do not have the expertise required to solve an indispensable step in a compound modeling process (Pebesma et al., 2011). However, the gain in flexibility when linking models will be directly proportional to the availability of the services provided. If the service components are basic, generic and self-explanatory they are more likely to meet the end-users' requirements.

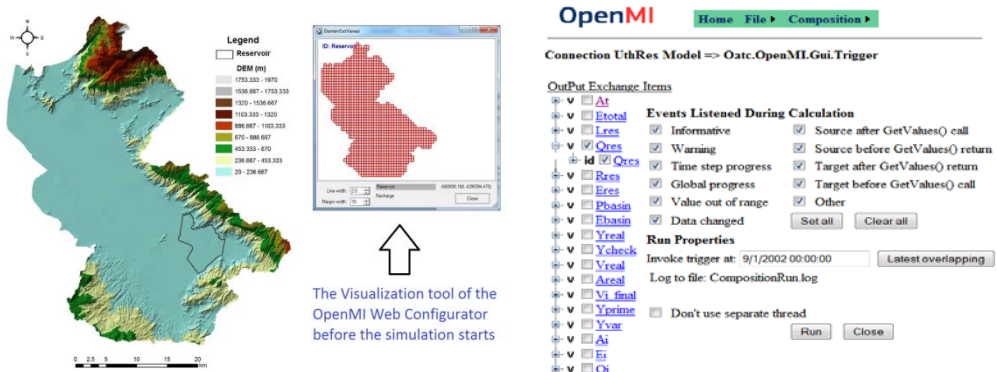

Fig. 5 Left) Digital Elevation Model of Lake Karla watershed in the location of the reservoir and visual representation of the model grid cells in the Web Configurator. Right) Variability of input/output exchange items in the linked simulation and monitoring of process interrupts

The web application is based on the composition class which implements all the web methods relating to the coupling composition consisting namely of: adding models, initiating triggers, setting up connections, indicating input and output exchanged items and monitoring output properties. The web application works with the session oriented methodology to assist the user authentication and the security of data. Every user starts his own session in order to deposit a model and its input data so that, there is no sharing among other users. A session variable is used to store the serialized composition class every time when an update or an interrupt occurs. Through the OpenMI web configurator, shown in Figure 5 (left), modelers can upload models which carry their model descriptions (GeoLocation, involved variables, node specification, model revision, time series etc.). Information is passed into the web service using the Simple Object Access Protocol (SOAP), specification for exchanging structured information in the implementation of Web Services. The calling of the trigger to start the simultaneous simulation in the OpenMI web configurator preserves the specifications of the WSDL language generated by the service which basically is an XML-based language that is used to describe the functionality offered by the service.

Conclusion and Future Challenges

We have implemented a collaborative environmental modeling and water resources prototype under which, several water resources models can be plugged, interlinked and exchange data during concurrent simulation. For models that due to their proprietary software functionalities cannot be coupled, we provide a semi-automatic methodology by integrating an additional database in parallel to the GIS that stores all the necessary data format conversions, supports strong data assimilation in the visualization

component and converts the stored measurements in XML format. The system uses the standard of OpenMI for data interchange when spatial and temporal synchronization of the models is achieved. We added an extension to OpenMI through which, users can migrate models, couple models and run simultaneous simulations of them as web services. Via a web configurator, this coupling allows users of the system to remotely run the coupling module, and therefore initiating a cloud repository where modellers can deposit models and data to be simulated. The synergy and interoperability between models under the same framework is therefore a more complete solution to the challenge of integrated environmental modeling. The approach we use with the inclusion of an online and remote model coupling gives the modeller community a useful tool to run hydrological simulations using a variety of models and to provide ground for comparative analysis. We therefore believe that, decision support systems that use this type of model interoperability are able to help towards more efficient use of water resources and thus protect the environment.

We plan to further extend the system, by providing additional web services, implementing new calibration algorithms for model optimization and hopefully to finally end with an online decision support system to evaluate regional water resources.

Acknowledgement

This research has been co-financed by the European Union (European Social Fund - ESF) and Greek national funds through the Operational Program "Education and Lifelong Learning" of the National Strategic Reference Framework (NSRF) - Research Funding Program: ARCHIMEDES III: Investing in knowledge society through the European Social Fund.

References:

- Castronova, A. M., J. L. Goodall, and M. Ercan (2013), Integrated modeling within a Hydrologic Information System: An OpenMI based approach, *Environmental Modeling & Software*, doi:10.1016/j. envsoft.2012.02.011, 39, 263-273.
- Gerakis P.A. and Koutrakis E.T. (eds), "Greek wetlands. Greek Center for Biotopes-Wetlands", (EKBY), Athens (in Greek), 1996.
- Janse J. H. and Aldenberg T. The eutrophication model PCLake, RIVM, Bilthoven, report no. 732404005, 1996.
- Granell, C., Díaz, L., and Gould, M., (2010). "Service-oriented applications for environmental models: Reusable geospatial services", *Environmental Modeling and Software*, 25(2), pp. 182-198, ISSN: 1364-8152.

- Janse, J. H., "A model of nutrient dynamics in shallow lakes in relation to multiple stable states", *Hydrobiologia* Volume 342/343, pp. 1–8, 1997.
- Kokkinos K., Samaras N., Loukas A. and Mylopoulos N., (2014). A Collaborative Approach to Environmental Modeling. *IEEE 23rd International Conference WETICE*, pp. 223-228.
- Kragt, M.E., Newham, L.T.H., Bennett, J., Jakeman, A.J., (2011). An integrated approach to linking economic valuation and catchment modelling. *Environmental Modelling & Software* 26 (1), pp. 92-102.
- Laniak, G. F., G. Olchin, J. L. Goodall, A. Voinov, M. Hill, P. Glynn, G. Geller, N. Quinn, M. Blind, S. Peckham, S. Reaney, N. Gaber, R. Kennedy, and A. Hughes (2013), Integrated environmental modeling: A vision and roadmap for the future, *Environmental Modelling & Software*, 39, 3-23, doi:10.1016/j.envsoft.2012.09.006.
- Laspidou CS, Gialis S. Lake Karla and the contradictory character of Greek Environmental Policies: A brief historical overview. *Proceedings to the IWA Regional Symposium on Water, Wastewater and Environment: Traditions and Culture*, 22-24 March 2014, Patras, Greece.
- Loukas A., Vasiliades L., and Mpastrogiannis, N., (2003). Hydrologic simulation of surface water balance in Yermasoyia watershed, Cyprus. In Sidiropoulos E., Iacovides I., (eds) *Research of water resources in Cyprus*, Nicosia, Cyprus, pp. 83-114 (in Greek).
- Loukas A., Mylopoulos N., and Vasiliades L., (2007). A modeling system for the evaluation of water resources management strategies in Thessaly, Greece. *Water Resources Management*, 21(10), pp. 1673-1702.
- Maidment, D.R., 2008. Bringing water data together. *Journal of Water Resources Planning and Management* 134 (2), 95.
- OpenMI, (2007). Open Modeling Interface. www.openmi.org, (last accessed, 05.28.2015).
- Otto-Banaszak, I., Matczak, P., Wesseler, J., Wechsung, F., (2011). Different perceptions of adaptation to climate change: a mental model approach applied to the evidence from expert interviews. *Regional Environmental Change* 11, pp. 217-228.
- Pebesma, E., Cornford, D., Dubois, G., Heuveling, G., Hristopoulos, D., Pilz, J., Stöhlker, U., Morin, G. and Skøien, J., (2011). "INTAMAP: the design and implementation of an interoperable automated interpolation Web service", *Computers & Geosciences*, 37(3), pp. 343-352.
- Tarboton, D.G., Horsburgh, J.S., Maidment, D.R., Whiteaker, T., Zaslavsky, I., Piasecki, M., Goodall, J., Valentine, D., Whitenack, T., 2009. Development of a community hydrologic information system. In: *18th World IMACS/MODSIM Congress*. Cairns, Australia, pp. 988-994.

IMPACTS OF HOT IN-PLACE RECYCLING TECHNIQUES IN PAKISTAN

Dr. Salahuddin Azad

National University of Science and Technology Pakistan

Abstract

A hot in-place recycling (HIR) technique was employed for the first time on Lahore-Islamabad Motorway in 2005 to rehabilitate sections where the rut depth was about 40 mm. Since HIR technology was new to Pakistan, research was carried out to study the effects of recycled wearing course of pavement. It was accomplished by comparing structural adequacy of pavement and material characterization before and after recycling. Analysis of recycled HMA wearing course indicated a reduction in modulus for a mix that was very stiff and aged prior to recycling. Relative degradation of the HMA wearing course was observed; however, it remained close to standard specifications specified by Executing Agency National Highway Authority (NHA). The research enhanced awareness of HIR among local engineers and contractors.

Keywords: Hot in-place recycling, Resilient modulus, Volumetrics, Gradation, dynamic shear rheometer, Performance grade

Introduction

The Tremendous increase in vehicular traffic, increased use of hot mix asphalt (HMA) pavements, ensuring traffic flow during execution of work, maintenance of geometrics and removal of old pavements are challenging pavement management tasks for any agency. Efficient rehabilitation techniques with minimal waste of valuable construction materials have become a necessity of the time in management of pavements at acceptable serviceability levels (AASHTO, 1993). The HIR technique has proven to be a viable on-site method for rehabilitation of pavements at low costs. HIR can successfully treat surface defects such as corrugation, surface rutting and longitudinal and slippage cracking to a depth of 50 mm (Kandhal and Mallick, 1997). In Pakistan, HIR technique was on the sections rutted to a depth of 38-50 mm.

Scope of study

The study was conducted to draw a comparative evaluation of the selected pavement sections before and after HIR. A Field work involved HMA coring before and after recycling and recording temperatures during various stages of HIR, Laboratory investigations like HMA volumetric analysis, aggregate gradation analysis, extracted asphalt properties (penetration test and DSR) and resilient modulus before and after recycling the selected pavement sections were conducted.

Materials and methods

Methodology adopted for this research before and after recycling has been given in Figure -1.

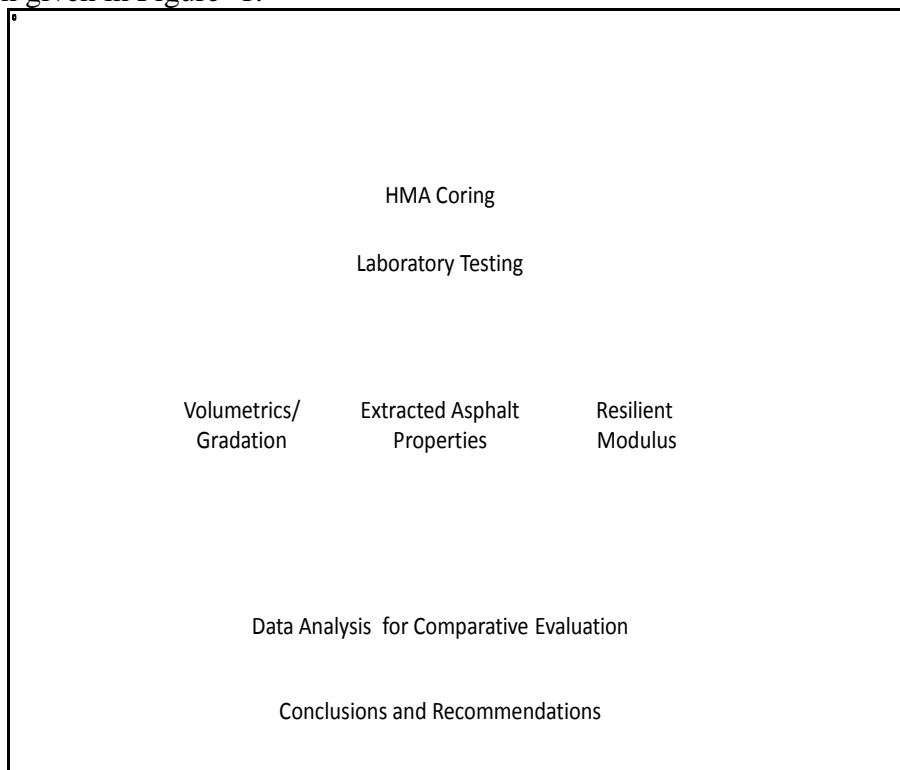

Figure -1 Evaluation method

Site selection

The selected site carriageway was divided into three sections of 150 m each separated by 10 m transition length as shown in Figure 2. The original pavement design of the test sections has been explained in Figure 3. All cores (Figure-4) were 102 mm diameter with thickness ranging between 44 mm (1.73”) to 55 mm (2.17”).

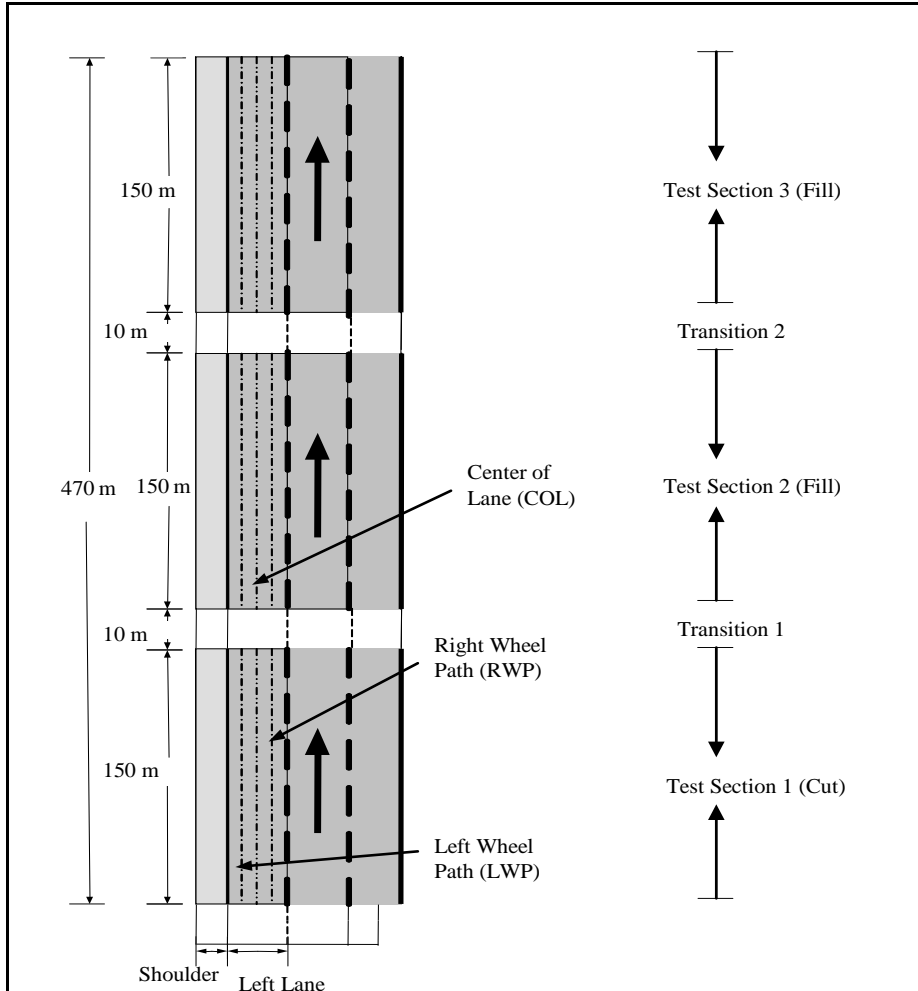

Figure -2 Different sections of Selected Site

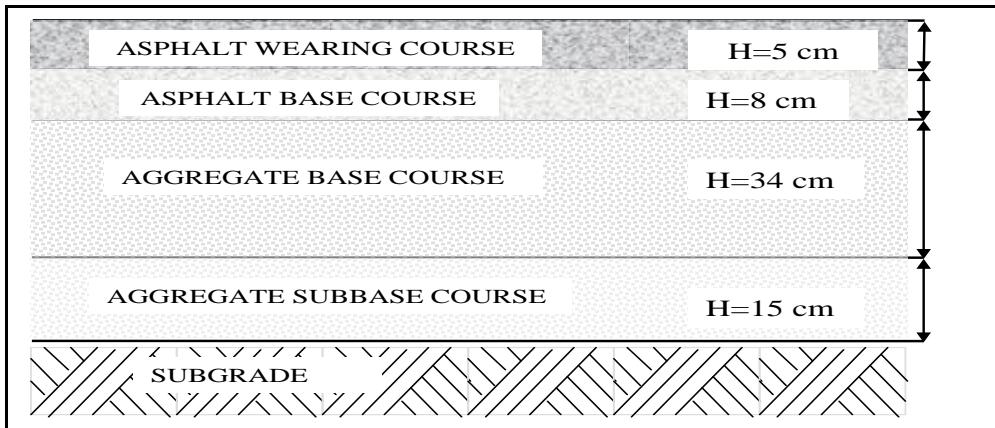
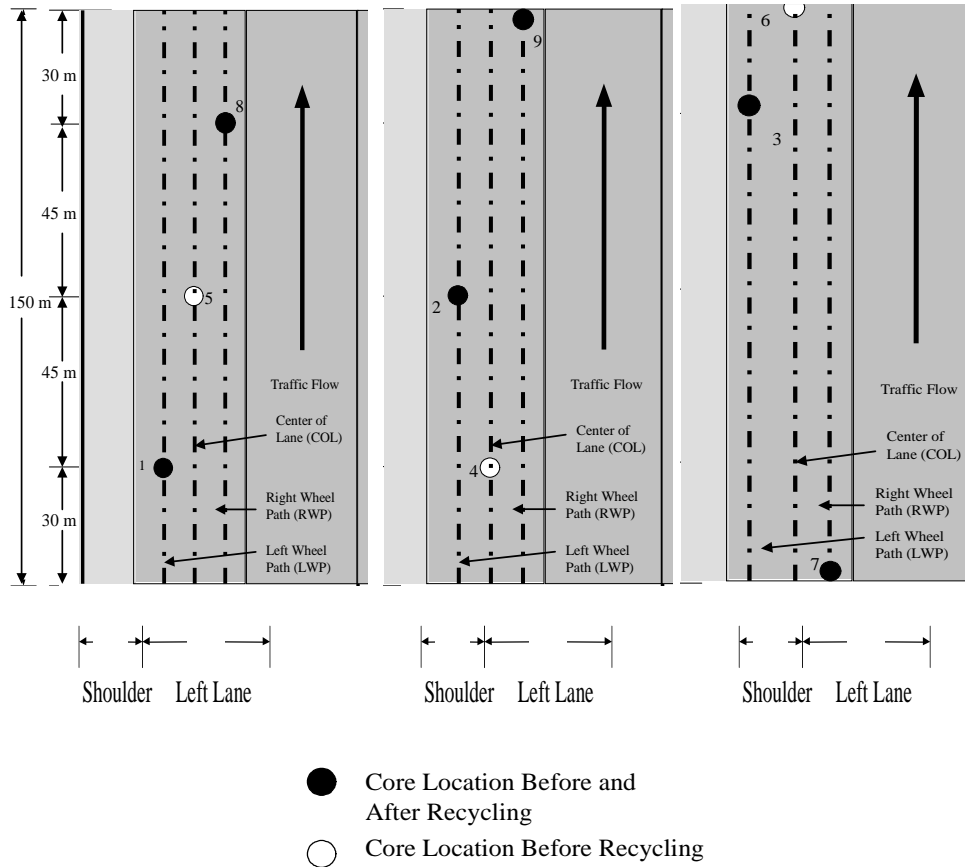

Figure -3 Cross section of original pavement



(a) Section 1 (b) Section 2 (c) Section 3

Figure- 4 Coring plan of selected section

HIR Equipment

Technical specifications of the panel heating machine HM 4500 and Remixer RX 4500 units (Figure-5,6,&7) are tabulated in Table 1 and 2. HM 4500 heats pavement gently by infrared heater elements up to 60 mm of depth.

Table- 1 Specifications of panel heating machine HM 4500

Heating Width (max)	4.50 m
Heating Area	44.64 m ²
Heater Elements (adjustable)	Infrared
Max. Heating Performance	2,260 kW
Volume Gas Tank (Propane)	6,000 liters
Engine Output	79 kW
Operating Weight	22,600 kg

Source-Website

Table -2 Specifications of Remixer RX 4500

Working Width	3.0-4.5 m
Working Depth	0-60 mm
Engine Output	220 kW
Operating Weight	48,820 kg
Number of Wheels	4
Max. Heating Performance	2,210 kW
Travel Drive System	Hydraulic / all-wheel

Source-Website



Figure- 5 Pre-heating unit



Figure- 6 Scarifying and heating unit



Figure -7 Remixing unit

Field Tests

A total of 9 HMA wearing course cores (3 cores from each section) before recycling and 6 HMA wearing course cores (2 cores from each section) after recycling were extracted for further laboratory testing and evaluation. During the application of HIR process, temperatures were measured at various stages of recycling. Surface temperatures recorded at

different times during various stages of the HIR process have been tabulated in Table-3. There were three panels in front and one on rear of panel heating machine HM 4500. The minimum laydown temperature for 5 cm (2") with base temperature greater than 32°C (90°F), should be around 126°C (260°F) Roberts et al. (2009). Temperatures recorded at different times during various stages of HIR process indicated that they were well below the prescribed guidelines even though in HIR laydown temperatures are lower than conventional HMA. About 1% fresh asphalt binder (penetration grade 60-70) was added during the recycling process. Virgin aggregate and new HMA was not added during HIR on test sections.

Resilient modulus Test

The cores removed from selected sites before and after recycling (Figure-4) were brought to the laboratory. The wearing course was separated from HMA cores. Resilient modulus testing was performed on HMA wearing course cores (102 mm diameter) according to ASTM D 4123 and laboratory testing procedure by Barksdale et al. (1997). Universal testing machine (UTM-5P) by Industrial Process Control Global-IPC (IPC) was used for the tests. A total of 9 asphalt concrete wearing course (3 cores from each section) before and 6 asphalt concrete wearing course (2 cores from each section) after recycling with thickness ranging between 44 mm (1.73") to 55 mm (2.17") were tested. Barksdale et al. (1997), suggest load ranges of 30, 15, and 4% of tensile strength measured at 25°C to be used to conduct the test at temperatures of 5 ± 1 , 25 ± 1 , and 40 ± 1 °C, respectively. The indirect tensile strength of asphalt core was determined by using Marshall loading frame based on *TXDOT Designation: Tex-226-F*. A Haversine load duration of 0.1 sec with rest period of 0.9 sec (frequency, 1Hz) was used for resilient modulus test as recommended by Barksdale et al. (1998). Poisson's ratio values used during the resilient modulus test was as recommended by Von Quintus et al. (2002). Temperature, loads, preconditioning cycles and poisson's ratio used for resilient modulus test of HMA wearing course before and after recycling are tabulated in Table-4. The summary of resilient modulus test results of HMA wearing course before and after recycling are in Table-5. Core designation includes whether the core is taken before or after recycling (BR/Before Recycling, AR/After Recycling), location (L/Left Wheel Path, C/Center of the Lane, and R/Right Wheel Path), test section number, and core number.

Table- 3 Temperatures (°C) variation at different stages of HIR process

Section	Time (hrs)	Panel Heating Machine e Front			Panel Heating Machine e Rear	Mix under Screenshot	After compaction
1	1000	81.8	92.5	127.0	136.0	92.0	66.0
1	1200	90.0	102.0	150.0	155.0	97.0	70.0
2	1300	100	117.0	170.0	175.0	102.0	74.0
2	1400	85.0	96.0	135.0	145.0	95.0	69.0
3	1600	94.0	107.0	160.0	160.0	101.0	72.0
Average		90	103	148	154	97	70

Source; Field work

Table- 4 Resilient modulus test procedure

Temperature (°C)	Load (N) before Recycling	Load (N) after Recycling	Cycles (No.)	Poisson's ratio
5	1250	1100	100	0.25
25	625	550	100	0.30
40	150	150	50	0.40

Source; Field work

Table -5 HMA Wearing Course Resilient Modulus Test Results

Sample #	Modulus (MPa)			Bulk Specific Gravity
	5°C	25°C	40°C	
Before recycling				
BRL-1-1	15662	10724	3975	2.44
BRC-1-5	16479	7390	3397	2.44
BRR-1-8	18558	10553	3040	2.46
Average	16900	9556	3471	2.45
BRL-2-2	21246	8348	2436	2.46
BRC-2-4	25801	11535	2891	2.46
BRR-2-9	16429	7806	2328	2.46
Average	21159	9230	2552	2.46
BRL-3-3	16172	6585	1427	2.46
BRC-3-6	16673	10880	2219	2.44
BRR-3-7	12813	4447	1040	2.32
Average	15219	7304	1562	2.41
Overall Average	17759	8696	2528	2.44
Std Dev	3766	2385	923	0.05
CoV	21%	27%	36%	2%
After recycling				
ARL1-1	11536	3253	802	2.28
ARR1-8	9054	3437	940	2.34
Average	10295	3345	871	2.31
ARL2-2	10547	4718	953	2.33
ARR2-9	8447	2318	672	2.28
Average	9497	3518	813	2.30
ARL3-3	9405	2059	550	2.26
ARR3-7	9586	2646	625	2.27
Average	9496	2352	588	2.27
Overall Average	9763	3072	757	2.29
Std Dev	1109	965	168	0.03
CoV	11%	31%	22%	1.50%

Source; Field work

Volumetric and gradation testing

Bulk specific gravity of asphalt concrete core specimen was tested in accordance with AASHTO T 166-07. Extraction procedures for removing asphalt from aggregates in an asphalt mixture followed the methods listed in ASTM D2172 (Centrifuge Extraction). Recovery of asphalt binder from solution was done with binder recovery apparatus 45-3720 by ELE international according to British Standard, BS 598. Volumetric properties of asphalt wearing course before, and after recycling (Table-6) and the gradation envelops of HMA wearing course before and after recycling has been given in Figure 8 and 9.

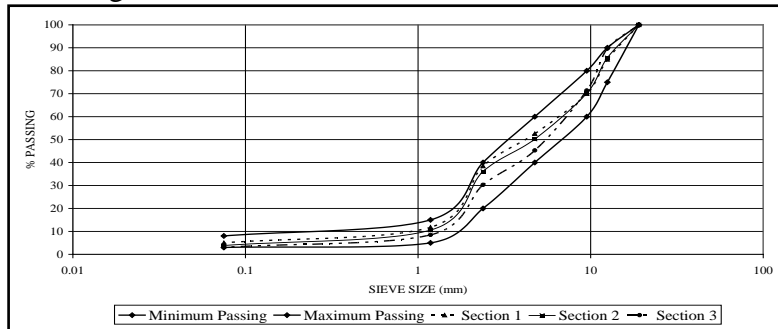

Figure -8 Gradation analysis of HMA wearing course before recycling

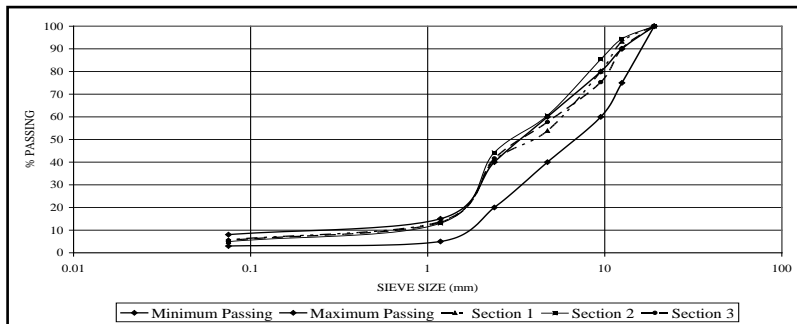

Figure -9 Gradation analysis of HMA wearing course before recycling

Table- 6 volumetric properties of HMA wearing course

Sample#	Agg %	Asphalt %	Weight (gm)			(b)-(a)	Bulk Specific Gravity (Gmb)	Asphalt Gs	Gse of Agg	Max Theoretical Gs (Gmm)		% Air Voids	VMA %	VFA %
Before recycling wearing course cores														
BRR-1-8	95.1	4.9	789.8	469.2	790.8	321.6	2.46	1.03	2.76	2.55		3.70	14.2	73.9
BRL-2-4	94.9	5.1	867.4	515.5	868.4	352.9	2.46	1.03	2.76	2.54		3.32	14.3	76.8
BRC-3-6	94.8	5.2	836.5	495.9	833.3	337.4	2.44	1.03	2.76	2.54		2.33	13.6	82.9
Average	95	5.0					2.46					3.12	14.0	77.9
After recycling wearing course cores														
ARL1-8	94.5	5.5	830	472.8	830	357.4	2.34	1.03	2.70	2.48		6.32	17.6	64.1
ARL2-9	94.4	5.6	852.4	477.8	856	378.2	2.28	1.03	2.70	2.48		8.95	20.1	55.5
ARL3-3	94.2	5.8	694.8	385.8	693	307.2	2.26	1.03	2.70	2.47		8.36	20.0	58.2
Average	94.4	5.6					2.30					7.8	19.2	59.3

Source; Field work

Reclaimed asphalt binder test

The penetration grade as well as the performance grade (PG) of recovered asphalt binder from asphalt cores before recycling was determined according to ASTM D 5-06. Penetration grades of recovered asphalt binder before recycling ranged between 55 and 57 whereas after recycling ranged between 58 and 60. The PG (higher temperature only) was determined by Dynamic Shear Rheometer (DSR) according to AASHTO T 315-06. The RAP binder was tested in the DSR at a high temperature as if it was original (McDaniel and Anderson, 2001). Performance grades of recovered asphalt binder before recycling ranged between 58 and 64 whereas after recycling ranged between 52 and 58.

Results and discussion

Analysis of resilient modulus data

Wearing course layer moduli show that the material is stiff; however, the variation of modulus was in a medium range. Average values of 17759 MPa at 5°C, 8696 MPa at 25°C and 2528 MPa at 40°C (Table-5) can be taken as representative values. Test Section-1 contained a stiffer HMA layer as compared to other test sections at 25°C and 40°C. Section-2 has highest modulus values at 5°C. Overall average specific gravity of 2.44 shows that material has become too dense and compact with age that may be a cause of high modulus. This has also been reflected in low air void results reported in Table-8 and wearing course high modulus values measured by Falling Weight Deflect meter (FWD) of the same sections given by Qureshi et al. (2010) of same sections. The results for wearing course layer moduli show that the material is of medium stiffness after hot in-place recycling. Average values of 9763 MPa at 5°C, 3072 MPa at 25°C and 757 MPa at 40°C (Table-5) can be taken as representative values. Section-2 contains stiffer HMA layer as compared to other test sections at 25°C whereas Section-1 contains stiffer HMA at 40°C and at 5°C. Average specific gravity of 2.30 shows that density of the HMA wearing course layer has significantly reduced. This will cause the pavement to become more susceptible to rutting and moisture related damage but also prone to fatigue cracking. Based on the above results, analysis can be summarized as follows:

- The reduction in stiffness of HMA layer is probably due to addition of fresh asphalt and reduced density.
- The significant reduction of modulus at 40°C will increase the pavement susceptibility to rut and moisture related damage of HMA wearing course.

Analysis of volumetrics and gradation

The recovered asphalt binder, air voids and bulk specific gravity before recycling ranged between 4.9 and 5.2 %, 2.33 and 3.70 %, 2.44 and 2.46 (Table 6), respectively. Average air voids of 3.12% along with average bulk specific gravity of 2.46 before recycling shows that the HMA wearing course layer has become denser with age. The HMA wearing course layer important volumetrics parameters were measured to be average asphalt content (5%), average VMA (14%) and average VFA (77.9%), all remained within reasonable limits.

The recovered asphalt binder, air voids and bulk specific gravity after recycling ranges between 5.5 and 5.8 %, 6.32 and 8.95 %, 2.26 and 2.34 (Table 6), respectively. Average air voids of 7.8% along with average specific gravity of 2.30 after recycling shows an increase in air voids and reduction in density as compared to volumetric data before recycling. Insufficient compaction seems to be one of the causes of the reduction in density, even after fresh asphalt was added to the pavement. HMA wearing course layer important volumetrics parameters shows a trend of increase in asphalt content (5.5%) and VMA (19.2%) and decrease in VFA (59.3%) but all within reasonable limits. It is assumed that reduction in stiffness in HMA wearing course layer is due to a combination of higher asphalt content, finer gradation, lower density and increased VMA. This follows the finding of a study carried out by Roque et al. (2002) that mixes with higher VMA exhibited lower stiffness.

The gradation of HMA wearing course before recycling (Figure 8) was well within gradation envelop of NHA “Class B” specification. The degradation of the aggregates in AC wearing cores due to scarification (after recycling) was observed (Figure-9). However it remained within the limits of NHA “Class B” asphalt wearing course specifications.

Analysis of reclaimed asphalt data

Based on the results, analysis can be summarized as follows:

- Binder has softened, but not significantly, after recycling as indicted by penetration results given in Section 6.3. The softening of asphalt binder is probably due to addition of fresh asphalt. Increase in penetration showed that the effect of infra-red heating was relatively gentle and its effects on age hardening were negligible. Based on the limited number of samples used for extracting binder.
- There is no significant change in PG after recycling given in Section 6.3.

Conclusion

Based on the results of the field, laboratory investigations and data analysis conducted during the investigation of hot in-place recycling effects on HMA wearing course on Lahore-Islamabad Motorway, the following conclusions are inferred

The test sections contained very stiff and aged HMA layer with presence of medium level rutting. The penetration and performance grade of binder showed that effect of infra-red heating was gentle and binder has softened minutely, probably due to addition of fresh asphalt. Recycled wearing course seems to be structurally sound on the basis of resilient modulus test results whose values were in medium range. Insufficient heat penetration was observed in the wearing course due to fast speed of HIR train. In-place air voids of recycled wearing course are lower probably due to lower mix temperature and insufficient compaction.

References:

- AASHTO (1993). "Guide for design of pavement structures". American Association of State Highway and Transportation Officials, Washington, DC, USA.
- Barksdale, R. D., Alba, J., Khosla, N. P., Kim, R., P. C. Lambe, P. C., and Rehman, M. S. (1997). "Laboratory Determination of Resilient Modulus for Flexible Pavement Design." *NCHRP Web Document 13 (Project 1-18): Contractor's Final Report*, TRB, National Research Council, Washington, D.C., USA.
- Kandhal, P. S., and Mallick, R. B. (1997). "Pavement Recycling Guidelines for State and Local Governments – Participant's Reference Book". *Publication FHWA-SA-96-054*. National Center for Asphalt Technology, Auburn, AL, USA.
- McDaniel, R. and Anderson, R. M. (2001). "Recommended Use of Reclaimed Asphalt Pavement in the Superpave Mix Design Method: Technician's Manual". *NCHRP Report 352*, TRB, National Research Council, Washington, D.C., USA.
- Qureshi, N. A., Akram, T., and Ali, S. (2010). Field Evaluation of Hot In-Place Recycling Experience in Pakistan - A Case Study. *Proceedings of Makassar Conference in Civil Engineering*, Makassar, South Sulawesi, Indonesia,
- Roberts, F. L., Kandhal, P.S., Brown, E.R., Lee, D.Y., and Kennedy, T.W. (2009). "Hot Mix Asphalt Materials, Mixture, Design and Construction, USA.
- Roque, R., Birgission, B., Tia, M., and Nukunya, B. (2002). "Evaluation of Superpave Criteria for VMA and Fine Aggregate Angularity: Voids in

Mineral Aggregate (VMA)”. *Florida Department of Transportation Report No. WP11511865*, Vol. 1

Von Quintus, H.L. and Simpson, A.L. (2002). “Backcalculation of Layer Parameters for LTPP Test Sections” *Layered Elastic Analysis for Flexible and Rigid Pavements, Research Report, Volume II, Long-Term Pavement Performance Program*, Federal Highway Washington, DC, USA.

INTERNATIONAL LEGAL REGULATION OF GREENHOUSE GAS EMISSIONS AND UKRAINIAN POLICY ON IMPLEMENTATION OF THE KYOTO PROTOCOL

Liubov Zubkova, research member
National Academy of Internal Affairs, Ukraine

Abstract

The aim of the report is provide comprehensive analysis of international legal regulation of greenhouse gas emissions limitation and Ukrainian experience in this area. There is a common concern that global warming only makes our world warmer. But it tends to cause substantial climate changes resulting in extreme natural events like droughts, flooding of the coastal territories, powerful hurricanes and abnormal temperatures. By the end of 21st century these changes are expected to put millions of lives in danger. This negative tendency is currently observed in many countries including Ukraine. The Kyoto Protocol is an international agreement linked to the United Nations Framework Convention on Climate Change, which commits its Parties by setting internationally binding emission reduction targets. It is the first agreement between nations to develop global solutions for economic and environmental problems in the 21st century. Analysis of the regulatory instruments regarding global climate change shows that Ukraine still hasn't adopted the strategic approaches to legislative regulation of greenhouse gas emission. There is no clear policy in the tax assessment, application of excise taxes, environmental taxes, consumer/manufacturer taxes, rate differentiation and other ways of promoting energy efficiency and energy overuse remedies. But the mechanisms of legislative implementation of legal regulation are being designed at this stage.

Keywords: Kyoto Protocol, United Nations Framework Convention on Climate Change, implementation, global warming, state regulation

Introduction

There is a common concern that global warming only makes our world warmer. But it tends to cause substantial climate changes resulting in extreme natural events like droughts, flooding of the coastal territories,

powerful hurricanes and abnormal temperatures. By the end of 21st century these changes are expected to put millions of lives in danger.

Scientific research proves the increase of different extreme natural phenomena in caused by global climate change in the world. For example, number of hurricanes (Categories Four and Five) has increased up to 1970 for approximately 75%. The highest indicators were recorded in northern and south-western parts of the Pacific and Indian Ocean. It should be pointed out that the number of hurricanes in North Atlantic region has exceeded the limit during the last decade.

The number of drought-stricken regions has also grown – it was mainly caused by the disbalance between unessential decrease of terrestrial weather elements and enhanced evaporation due to warming processes. The same negative tendency is currently observed in Ukraine – number of dangerous natural phenomena is increasing year by year.

Today many scientists consider the unprecedented rapid climate changes to be the result of anthropogenic influence (first of all we talk about fossil fuel burning). Many countries, especially the least developed ones, suffer the most from these changes. Specialists claim that huge resources are required for the regulation and stabilization of the climate and limitation of greenhouse gases emission.

I.

The Kyoto Protocol is a legally binding agreement under which industrialized countries take measures for climate change prevention. Many specialists are involved in cost estimate procedures concerning reduction of greenhouse gas emission, development of environmentally-friendly economic programs and mechanisms of the Protocol implementation (e.g. mechanisms of transferring the carbon credits and taxes). All countries must focus on limitation of the greenhouse gas emission to prevent the global warming. The Kyoto Protocol which extends the 1992 United Nations Framework Convention on Climate Change (UNFCCC) has become a final result of international efforts aimed to search the globalized solutions of economic and ecological issues. It defines the key structural elements of the foundation of anti-climate change global campaign in the 21st century. It must be mentioned that the majority of world's population neither heard of the abovementioned agreements nor got its point. Meanwhile the climate change issues directly affect our lives and the solution is of common concern. The aim of this report is to provide the comprehensive analysis of the Kyoto Protocol and its influence on the legal regulation in Ukraine and at international scale.

In 1970 UN Secretary-General mentioned “natural disasters caused by warming” in his Ecological Report. In 1972 the first UN Conference on

the Human Environment was held in Stockholm where the UN Environment Programme (UNEP) was adopted. It presented the solutions for the so called "first generation" environmental problems like water and air pollution, soil impoverishment etc. Since then the UN Environment Programme has become the most extensive and influential form of international cooperation within the scope of environmental protection. In 1983 the World Commission on Environment and Development was created for the UNEP purposes to be accomplished. In 1987 the Commission prepared the "Long-Term Development Programme" published later under the title "Our Common Future". This programme contained recommendations concerning development and improvement of national legislation on environmental protection. In 1980s within the context of the UN Environment Programme and in association with the World Meteorological Organization (WMO) many scientific seminars were convened where specialists came to a consensus on the abovementioned issues.

The majority of countries are capable of significant emission cut without additional expenses taking "painless" measures. These measures include easing of market limitations and economic disproportions (e.g. through changes in legal regulation and reduction of subsidies for fossil fuel extraction), prevention of carbon dioxide emissions from further increase (including other harmful substances of non-industrial origin) by, for example, "clearing" of car exhaust fumes.

In this aspect the 'fair play' principle in the climate change control is important as inherent value and tool effective implementation of international agreements.

In June 1992 the United Nations Framework Convention on Climate Change was adopted during the Earth Summit - United Nations Conference on Environment and Development (UNCED) – in Rio de Janeiro. This document contained recommendations concerning steps aimed at regulation of the abovementioned issue (came into effect on March 21, 1994). The history of Kyoto Protocol creation must be analyzed in a single package with this document. Recommendations deal with control of atmosphere changing and its stabilization on the safe level: "The main aim of the Convention is to promote measures for fixed retention of greenhouse gas emissions on the level of guaranteed anthropogenic threat exclusion concerning the balance of the planet's climate system".

The adoption of the Convention resulted in creation of specific area in the scope of international law and established the principles approved by its signatories.

USA was one of the first countries to ratify the Convention later followed by others. By December 1990 the United Nations Framework Convention on Climate Change had been adopted by 50 countries –

sufficient for the document to come in effect in three months according to law. The term is considered to be relatively short for this type of international treaty. Up to the Kyoto meeting the number of signatories increased to 167 (without EU).

The next step to be taken was the convocation of the first Annual Conference of the Convention Parties – this event was aimed to assess the steps taken after the Earth Summit and identify the key perspectives of further development. The decision was made to hold the Conference in Berlin in 1995. During the first session the members adopted the “Berlin Mandate” (1/CP1) which initiated the international negotiation process on development of new legally binding document to accompany the Convention in terms of specific commitments of the Parties concerning reduction or limitation of emissions. Discussion of organizational matters in Berlin was generally impassive without taking into account the failure of attempts to approve the formal procedural norms (this situation repeated in Kyoto). Emission trading was the most debatable issue but the compromise was eventually achieved – a set of specific steps was forwarded without clearly formulated commitments on emission limit for contributing countries. It resulted in new stage of intensive negotiation finished in Kyoto.

Conference in Kyoto has become one of the most important global events in the scope of international protection of environment. Representatives of different countries were to take clearly defined and legally unbeatable commitments admitting the previous agreements with their declarations and consensus to fail. “This agreement got a widespread approbation and was stated to become an important step in facing the challenges caused by the global climate change”. Still many contradictions can be traced in it causing the negotiation complexity: it was necessary to formulate the commitments more clearly, provide appropriate quantitative formula, dispense them between the participants and create a mechanism for execution control. The negotiation was concentrated on the emission reduction commitments taken by the countries according to the main provisions of the Berlin Mandate. The discussions concerned three main aspects: extent of commitments (period of fulfillment with consideration of emission sources and effects); level of commitments to be taken (including differentiation between parties); international mechanisms ensuring extra flexibility for the parties’ commitments to be fulfilled.

What conclusions can be made after analyzing the negotiation process on Kyoto Protocol? First of all, it must be noted that despite the common belief that in the age of economic globalization national state declines in importance the Kyoto Protocol is an agreement between national states. The environmental protection organizations declined almost all the mechanisms of credit transfer and demanded to toughen the commitments.

But governmental authorities were determined to achieve the consent and took all possible measures to protect the planet's atmosphere as well as their own interests.

The USA managed to keep the leading position during the negotiation process. American policy was aimed to achieve the highest possible flexibility in all aspects of climate change prevention where the political and economic interests of the state came to the fore. The negotiation process in Kyoto was also marked by internal conflicts of the developing countries which had difficulties in formulation of positive ideas and achievement of consent. Countries with transition economy were more successful in protection of their interests tackling it to EU and American interests in credit trading. Developing countries presenting 70% of the conference participants and 75% of world's population proposed a set of commitment initiatives through AOSIS – Alliance of Small Island States and issues concerning potential negative consequences (AOSIS made offers on climate change influence and OPEC (Organization of Petroleum-Exporting Countries) provided information on the effects of the measures taken). Many OPEC members admitted failure of attempts to limit the emissions in the developing countries to be the main flaw in the negotiation process due to the fact that they were mostly presented by the states with powerful industrial sector and leading world polluters (e.g. China and India). At the same time these states are not bound by any commitment according to the Kyoto Protocol despite the fact that extent of emissions produced by Indian and Chinese industry goes far beyond the estimated limits – specialists claim China to become the leading world polluter by 2030.

Commitments under Kyoto Protocol consider emissions of six greenhouse gases from defined sources; in general it means overall anthropogenic pollution in form of greenhouse gas emission in countries with developed industry.

Political struggle around the Kyoto Protocol caused the excessive flexibility in the commitment fulfillment. This struggle continues in scope of fulfillment of the commitments and usually traced in discussions on wash-off accounting regulations, credit trading and CDM (Clean Development Mechanisms).

States' attitude to the Protocol itself is different. EU member states tried to raise the bar up to 15% on emission reduction. Russia stood for establishment of differentiated emission reduction system to reach the overall level of 3%. Japan insisted on 5% reduction – this indicator was defined in the document for the majority of states. The USA insisted on inclusion of the commitments for developing countries into the text of the document. This requirement has substantial background – some of developing countries are massive industrial polluters (e.g. China and India).

These states use technologies of the developed countries in order to produce less carbon dioxide. The defined commitments stimulate Western Europe and Japan to develop more effective technologies and at the same time improve the ecological situation in developing countries.

Immediately after the final document was signed the USA representatives started to deliver the thoughts that ratification of the Kyoto Protocol is not of economic benefit. It was based mostly on the claims that its provisions contradict the Byrd-Hagel Resolution adopted by the US Senate in 1977 (before the USA joined the Kyoto Protocol).

According to the Resolution, the USA must not participate in international treaties which do not include obligatory target parameters and terms concerning not only industrially developed states but also developing countries if these treaties may “cause serious damage to the US economy”.

On May 31st, 2002 EU officially informed the UN about ratification of the Kyoto Protocol. It was an important step on the way to practical implementation of this document.

18th Conference of the Framework Convention Parties and 8th Meeting of the Kyoto Protocol Parties were held in Doha (Qatar) on November 26th – December 7th 2012. The negotiation resulted in adoption of the decision package called Doha Climate Gateway. Resulting from activities of the Special Work Group on Kyoto Protocol an amendment was issued. Second commitment period of the Kyoto Protocol started on January 1st 2013 and will finish on December 31st 2020 – industrially developed countries (37 in total) will continue to reduce the greenhouse gas. New Zealand, Russia and Japan refused to make commitments on emission reduction, Canada withdrew from the Kyoto Protocol. Total commitments presented by states on emission reduction during the second period comprise only 18% of the total emission level (1990) or 3% of the global emissions reduced. According to the last report of International scientific group on climate change the abovementioned commitments aren't capable of holding the global warming under 2°C. If this temperature is exceeded, it may cause irreversible natural effects. Researchers from Potsdam Institute of for Climate Impact prove that current global temperature is coming to 4°C. That is why countries must reconsider their commitments for the second Kyoto period. They will save their right for greenhouse gas emission credit trading of the first or second commitment period, but Amendment to the Kyoto Protocol provides limitations for the purchasing countries. If necessary, countries have right to buy not more than 2% of the established Assigned Amount Units (AAU) of the first period. Through transactions credits will be transferred from the excess reserves of the previous period of the selling country to the reserve of the purchasing country. In case if Ukraine exceeds the average emission level of 2008-2010 by 2020, the country will have right

to compensate the difference from the extra credit reserve of the first period. It is stated in the subsection 25 of the Amendment to the Kyoto Protocol.

The Doha Climate Gateway decisions didn't cover the issues on extra admissions for greenhouse gas emission in Kyoto Protocol after 2020. That is why during the process of new "post-Kyoto" agreement arrangement the issue on transfer and use of the Assigned Amount Units will arise. Currently full participation in the second commitment period requires countries to calculate new amount units, assess the potential effects of the Amendments and correct the commitments on emission reduction by 2020.

Working group on long-term cooperation encouraged industrially developed countries to raise quantitative commitments on greenhouse gas emission reduction according to conclusions made by International Group of Experts on Climate Change and actualize the low-carbon economic development. The decisions made will be used as base for formulation and implementation of the new mechanisms of the greenhouse gas reduction in parallel with the current flexible mechanisms of the Kyoto Protocol. Ways of providing financial support for adaptation to the climate change for developing countries weren't clearly defined though the necessity of financial support was outlined.

The following issue will concern the implementation of Kyoto Protocol to the UN Framework Convention on Climate Change and national legal regulations of greenhouse gas emissions in Ukraine.

Analysis of the regulatory instruments regarding global climate change shows that Ukraine still hasn't adopted the strategic approaches to legislative regulation of greenhouse gas emission. There is no clear policy in the tax assessment, application of excise taxes, environmental taxes, consumer/manufacturer taxes, rate differentiation and other ways of promoting energy efficiency and energy overuse remedies. But the mechanisms of legislative implementation of legal regulation are being designed at this stage.

The main reason for legal framework of the state regulation of greenhouse gas emission to be incomplete is that Ukraine has no convincing threat for the commitment infraction regardless of the period comparing to industrially developed countries.

Conclusion

For industrially developed countries state regulation of industrial greenhouse gas emissions is an obligatory condition for the national aim to be achieved. For example, EU members were obliged to cut the overall emissions by 8% - this task will not be fulfilled if the appropriate measures aimed at industrial emission reduction are not taken.

The majority of estimations covering greenhouse gas emissions clearly show that national emission level will be 30-40% lower of the average level in 1990. Up to now Ukraine had no necessity for any additional state regulations on greenhouse gas emission limitation and reduction on industrial (sector/enterprise) level. But these steps are essential – firstly, Ukraine must prepare to the next commitment period beforehand. Secondly, promotion of industrial emissions reduction will provide an opportunity to settle the issues on additional reduction to be sold on international AAU market. Finally, cautious and gradual implementation of state measures for greenhouse gas emission regulation will promote the “environmental” refocusing of economy with energy-saving technologies – it will be cost-efficient for the country and increase the GDP.

The second reason is absence of national strategies on industrial emissions reduction – attention was mostly paid to provision of reports concerning state regional and sector programmes.

No special taxes for greenhouse gas emissions were introduced in Ukraine – initial discussions in the scope of the Protocol ratification concerned only development of the State Concept on Legislative Regulation of the Greenhouse Gas Emissions. There is a clear contradiction between the experts’ recommendations of the state tax pressure to be decreased for the development of small and medium-sized business and positive experience of European countries where the additional “carbon” taxes were imposed on big enterprises.

Two main concepts are currently being implemented in Ukrainian legislation:

1. Planning of annual average emission amount;
2. Liberal mechanism for the emission level to be achieved and guaranteed according to the international commitments.

Legislative regulation of the greenhouse gas emissions must be gradually improved with attention to every detail in order to achieve maximum economic and environmental effect.

References:

www.eea.eu.int

www.un.org

www.unfccc.int

www.climatechange.ru

www.environmentaldefense.org

Report for the World Bank by the Potsdam Institute for Climate Impact Research and Climate Analytics. 4°C Turn Down Heat. Nov.2012

<http://unfccc.int/resource/docs/2012/cmp8/eng/109.pdf> 4

http://unfccc.int/files/meetings/doha_nov_2012/decisions/application/pdf/cop18_agreed_outcome.pdf

<http://zakon.rada.gov.ua/cgi-bin/laws/main.cgi?nreg=832-14>

<http://zakon.rada.gov.ua/cgi-bin/laws/main.cgi?nreg=435%2F96-%E2%F0>

DEVELOPMENT AND EVALUATION OF AN ADAPTIVE NEURO FUZZY INFERENCE SYSTEM FOR THE CALCULATION OF SOIL WATER RECHARGE IN A WATERSHED

Konstantinos Kokkinos, PhD

Department of Computer Science and Engineering,
Technological Education Institute, Larissa, Greece

Department of Civil Engineering, University of Thessaly, Volos, Greece

Athanasios Loukas, PhD

Department of Civil Engineering, University of Thessaly, Volos, Greece

Nicholas Samaras, PhD

Department of Computer Science and Engineering,
Technological Education Institute, Larissa, Greece

Abstract

Modeling of groundwater recharge is one of the most important topics in hydrology due to its essential application to water resources management. In this study, an Adaptive Neuro Fuzzy Inference System (ANFIS) method is used to simulate groundwater recharge for watersheds. In-situ observational datasets for temperature, precipitation, evapotranspiration, (ET_0) and groundwater recharge of the Lake Karla, Thessaly, Greece watershed were taken into consideration for the present study. The datasets consisted of monthly average values of the last almost 50 years, where 70% of the values used for learning with the rest for the testing phase. The testing was performed under a set of different membership functions without expert's knowledge acquisition and with the support of a five-layer neural network. Experimental verification shows that, the 3-3-3 combination under the trapezoid membership function with the hybrid neural network support and the 2-2-2 combination under the g-bell membership function with the same neural network support perform the best among all combinations with RMSE 4.78881 and 4.12944 giving on average 5% deviation from the observed values.

Keywords: Groundwater Recharge, Neuro Fuzzy Inference

Introduction

Soil water content is a key parameter that controls several hydrological processes and provides valuable information for water resources planning and management. Soil water modeling is very important for hydrology, weather and climate studies, water resource management, reliable irrigation design, and determining contaminants and nutrients' fate and transport. For a watershed, the groundwater recharge or deep drainage or deep percolation is the hydrologic process where water moves downward from surface water to groundwater. This process usually occurs in the zone below the level of the plant roots and is often expressed as a flux to the water table surface (Allison, 1978). Thus, the accurate estimation of groundwater recharge has an importance for water resource engineering problems such as soil water balance, irrigation systems and water supply for cultivation.

Furthermore, groundwater recharge is a process which is highly affected by a variety of non-linear factors like rainfall characteristics and overall precipitation, watershed morphology, evapotranspiration occurred in the area, soil moisture, etc. However, any effort to model the relationship between the groundwater recharge and the aforementioned factors would be confronted with difficulties including being highly non-linear, time-varying, spatially distributed, and stochastic. In addition, the deficiencies in data like missing data, noisy data, and in some cases having insufficient data present a major problem in groundwater recharge modeling.

In the past decades, several soft computing techniques have been applied in a number of diverse fields including system modeling, fault diagnosis and control, pattern recognition, financial forecasting and water resources. These techniques are known for their efficiency in dealing with complicated problems, with only sets of operational data available. However, the application of soft computing techniques to groundwater recharge modeling and the modeling of several hydrological processes in general is limited in the literature. To the best of our knowledge there are just few publications that are mostly related to the rainfall-runoff, the forecasting of inflows into a reservoir and some works that are dealing with the estimation and forecasting of the evapotranspiration factor in a watershed. From this point of view, the application of soft computing techniques for the forecasting of groundwater recharge initiates a new research branch for the groundwater modeling.

In this work we develop an Adaptive Network Fuzzy Inference System (ANFIS) for the forecasting of groundwater recharge. The modeling is based on using three input time series namely: temperature, precipitation and evapotranspiration. The output is a time series of the groundwater recharge. The system we develop is based on time series of monthly values since the decade of 1960's up to date and refers to the Lake Karla watershed

in Thessaly Greece. For this time period, we have also collected observational data regarding the groundwater recharge taken from several observation wells located in the area against which, we compare our ANFIS simulation.

In the following sections, we describe: a short yet compact literature review on the fuzzy inference systems, (FIS) and the applications of FIS into hydrological modeling, a description of the region under study, the development and the specifics of the ANFIS and a discussion of the results produced. Finally, conclusions and future challenges are drawn.

Literature Review

Most of the soft computing methodologies that deal with hydrological processes mainly focus on the prediction of rainfall-runoff and the evapotranspiration. The prediction of the rainfall-runoff is closely depended on factors such as the precipitation, evaporation, transpiration, interception, infiltration, stream flow and of course the variability in time and space of the above. However, the rainfall-runoff is practically contributes mainly to deep percolation especially for basins and watersheds with impermeable boundaries.

Research that deals with this prediction is divided in the categories of Artificial Neural Networks (ANN), Genetic Algorithms and Fuzzy Logic. However we concentrate only in the Fuzzy Logic methodology since our work is closely related to that category.

The work in (Talei et al., 2010) used an ANFIS for event-based rainfall-runoff modelling. The results of the ANFIS were compared with an established physical-based model. The study showed that ANFIS is comparable to the physical model and is found to give a better peak flow estimation compared to the physical model. Also (Dorum et al., 2010) compared the predictions of rainfall-runoff data using ANN and ANIFS methods. For this comparison they used a multi regression. This study showed that ANN and ANIFS models can be used in determination of rainfall runoff relationships of basins except peak situations.

The work by (Gerner, A., 2013) mainly focuses on the uncertainty regarding the potential, albeit unknown extent of groundwater basins based on continuous surfaces which represent the degree of membership to a distinct geographical entity (termed as fuzzy regions). The proposed strategy was applied on the large scale in an arid karst mountain range in northern Oman. The ANFIS methodology applied was in good agreement with the results of other conceptual hydrologic models used and was confirmed by the plausibility of average recharge rates for distinct response units and seasons.

Also (Umamaheswari and Kalamani, 2014) employed an ANFIS approach to observe its applicability on prediction and forecasting of

monthly groundwater level fluctuation in the study area (Amaravathi River Minor Basin). Their proposed model was the best fit by the hybrid technique with 6:3:3 membership functions with their forecasted model performance to exactly replicate the current situation of the groundwater system.

Finally, in the most recent research work, (Maiti and Tiwari, 2014) examined the comparative merits and demerits of ANN, Bayesian ANN and ANFIS in the predictive modeling of groundwater level fluctuations. Initially they carried out a sensitivity analysis based on an automatic relevance determination scheme to examine the relative influence of each of the hydro-meteorological attributes on groundwater level fluctuations. Then, the 3 techniques were applied to model the groundwater level fluctuation time series of six wells from a hard rock area of Dindigul in Southern India. They compared the 3 models using standard quantitative statistical measures such as Root Mean Square Error, (RMSE) and Pearson's correlation coefficient (R). Based on the above analyses, it was found that the ANFIS model performed better in modeling noise-free data than the other two models.

Study Area

We are dealing with the hydrological processing of the surrounding watershed of Lake Karla in Thessaly, Greece. The natural basin of Lake Karla was initially extended in an area of $1,663 \text{ km}^2$ but after the construction of complimentary works, the drainage area of the restored lake Karla will be 1171 km^2 (Figure 1-Left) (Loukas et al., 2007).

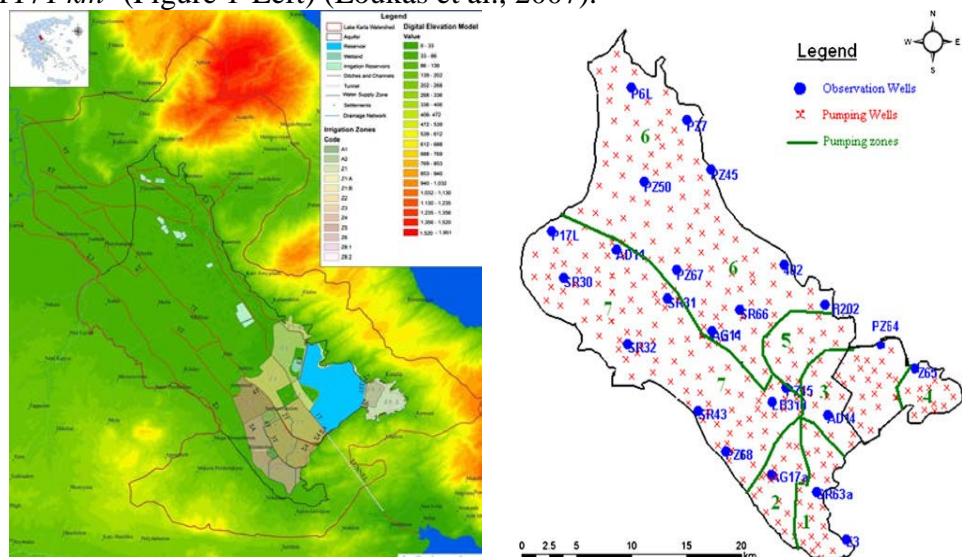

Fig. 1 Left) Lake Karla basin map indicating the underlying aquifer and the reservoir. Right) Aquifer map with pumping wells, zones and observation wells.

The region is characterized by its continental Mediterranean climate and there is a noticeable fluctuation of temperature between winter and summer time. The average temperature is 16-17° C and the mean annual relative humidity is 67%-72%. Snowfall is usually on the mountains during winter when significant snow peaks develop.

The waters of the region are used primarily for irrigation. Unfortunately, the water balance of the watershed is disturbed and it keeps deteriorating due to the overexploitation of the groundwater system resulting into the degradation of the available water resources. The phreatic aquifer of the lake has been simulated by the Modflow numerical model, (Harbaugh et al., 2000). The region has been discretized into an orthogonal grid of 40.000 cells, with a grid spacing of 200m X 197m. The resulting network has covered a region of about 500 km². To the west a (not so strong) hydraulic contact with the adjacent aquifer has been established and simulated with the General Head Boundary while the eastern boundary, consisting of schist was considered impermeable. The primary surface inflow of the model was the surface recharge. The study area was divided into 7 pumping zones, as is shown in (Figure 1-Right).

Adaptive Neuro Fuzzy Inference Systems

A fuzzy inference system (FIS) is an inference mapping that provides an intuition for the relationship between a series of input and output sets. This mapping from a given input to an output using fuzzy logic is called Fuzzy Inference (Adriaenssens et al., 2004). These systems have proved to work better when the input and output sets are time series data of the same time step. The FIS uses fuzzy logic principles to establish the input-output relationship through a rule based inference engine that consists of: (a) a rule-base, containing fuzzy if-then rules, (b) a data-base, defining the membership functions (MF) and (c) an inference system, combining the fuzzy rules and producing the system results (Sen, 2001). There are two types of popular FIS, the Takagi-Sugeno FIS, (Takagi and Sugeno, 1985) and the Mamdani FIS (Jang et al., 1997). The difference between the two approaches is the definition of the consequent parameters in the network. The FIS used in this study is a Takagi and Sugeno type FIS in which the rule base is constructed from the input-output pairs and it consists of five layers as seen in Figure 2: (L1) Input fuzzification, (L2) Fuzzy set database construction, (L3) Fuzzy rule base construction, (L4) Decision making and (L5) Output defuzzification.

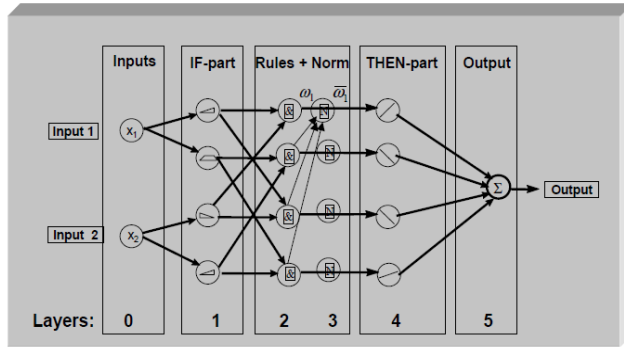

Fig. 2 Adaptive neuro-fuzzy inference system structure (Khoshnevisan et al. 2014)

In Layer 1, every node i is an adaptive node with a node function, given in eq. (1):

$$O_{1,i} = \mu_{A_i}(x) \quad \text{for } i = 1, 2 \quad (1)$$

where x indicates the input to node i , A_i represents the linguistic label associated with this node function, and $O_{1,i}$ is the membership function of A_i that specifies the degree to which the given x satisfies A_i . Regarding all other input y , the node functions have exactly the same behavior with the function family as x , with the condition that they belong to the same layer. In Layer 2, every node is a fixed node and acts as a simple multiplier. The outputs of these nodes are given by eq. (2):

$$O_{2,i} = w_i = \mu_{A_i}(x) \mu_{B_i}(y) \quad \text{for } i = 1, 2 \quad (2)$$

which are the so-called firing strengths of the rules.

Every node, in Layer 3, is an adaptive node indicated as N . The i -th node calculates the ratio of the i -th rule's firing strength to the sum of all rules' firing strengths. Eq. (3) shows how to obtain the output of this layer:

$$O_{3,i} = \bar{w}_i = \frac{w_i}{w_1 + w_2} \quad (3)$$

Each node, in Layer 4, is an adaptive node with a function given by eq. (4):

$$O_{4,i} = \bar{w}_i f_i = \bar{w}_i (p_i x + q_i y + r_i) \quad (4)$$

where \bar{w}_i is the output of layer 3, and $\{p_i, q_i, r_i\}$ are referred to as consequent parameters. Finally, the single node, in Layer 5, is a fixed node indicated as Σ (sum) that computes the overall output as the sum of all incoming inputs:

$$O_{5,i} = \sum_i \bar{w}_i f_i = \frac{\sum_i w_i f_i}{\sum_i w_i} \quad (5)$$

To construct an ANFIS from a given input/output data set, we first construct the FIS whose membership function parameters are tuned (adjusted) using either a back propagation algorithm alone or in combination with a least squares type of method (Singh et al., 2012). Learning using the

neuro-adaptive method works similarly to that of neural networks as for the procedure to learn information about a data set. In other words, ANFIS, which is a combination of ANN and FIS, has the benefits of the two models (Azadeh et al., 2011). Propagation and hybrid are two learning methods which are generally applied in ANFIS to clearly describe the relationship between input and output (Khoshnevisan et al. 2014). Hybrid learning, which is a combination of gradient decent method and least squares approach, can decrease the complexity of the algorithm and simultaneously increase the learning efficiency. The parameters associated with membership functions will change through the learning process using a gradient vector that facilitates in this recalculation. So every time the gradient vector is obtained, an optimization procedure can be performed to adjust parameters in order to reduce errors.

ANFIS application in predicting groundwater recharge

For our simulation we used the Matlab 2014(b)-ANFIS tool named ANFIS-Editor. The tool is designed to utilize different variables including a normalization method, trial step quantity and various data classification methods to achieve the minimum error between predicted values and real data. The number and type of membership functions, (MF), the type of output MF, the optimization method (hybrid or back propagation) and the number of epochs are five important adjustments in ANFIS to reach the most effective model with minimum errors. Figure 3 summarizes the types of membership functions used in our simulation. Our primary goal was to find the effect of these adjustments and their subdivisions in different combinations in order to develop these ANFIS models and compare the results. For this purpose, all possible combinations of these adjustments are applied to the same sets of training and testing data. For the aforementioned reasons, we included in our experiment four data monthly time series of 434 values with each one spanning almost the last 50 years of observations, namely: temperature, precipitation, evapotranspiration and groundwater recharge. The first three are used as the input data whereas the groundwater recharge is the one that our system predicts. Out of the 434 values, the first 303 values are used for training and the rest 131 for testing and forecasting.

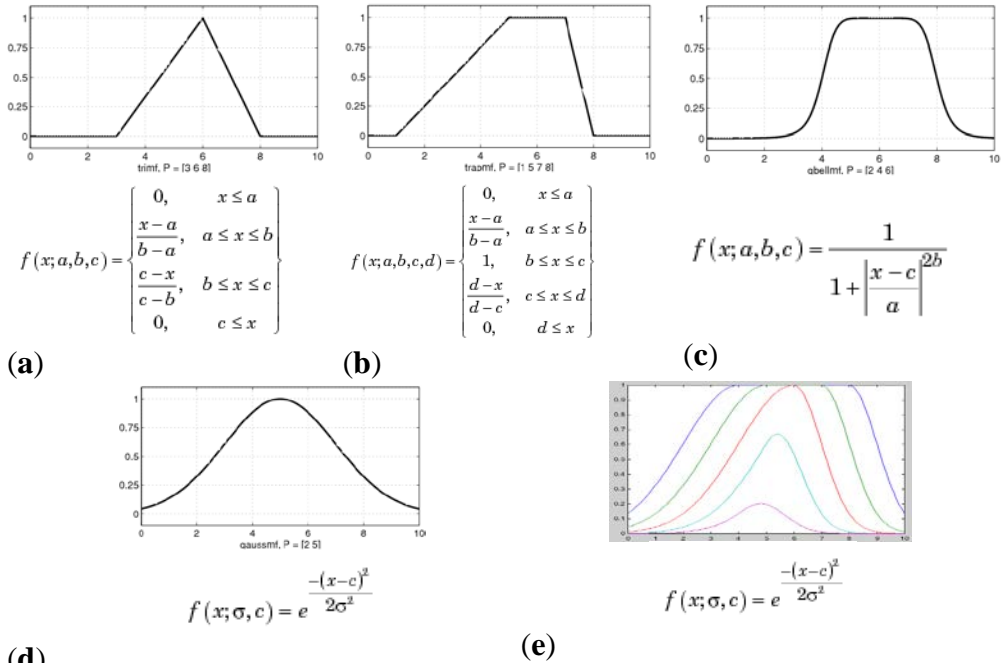

Fig. 3 Membership functions used in the ANFIS: (a) trimf, (b) trapmf, (c) gbelmf, (d) gaussmf and (e) gauss2mf.

The same split of the data set was used for every combination of membership function and function type. Figure 4 shows the loading of training data and the basic configuration of the ANFIS-Editor module.

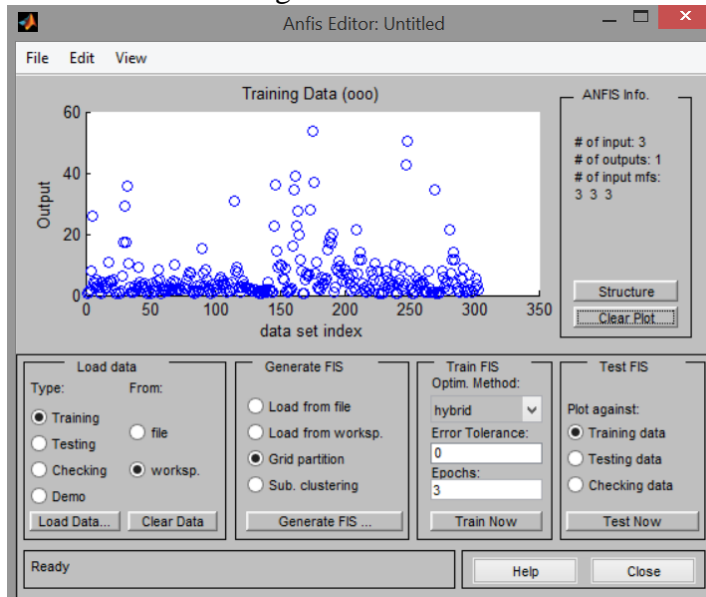

Fig. 4 Training phase in anfisedit and selection of the fuzzy inference system.

The Takagi & Sugeno fuzzy inference system contains an inference engine in which the conclusion of a fuzzy rule comprises a weighted linear combination of the crisp inputs rather than a fuzzy set (Takagi and Sugeno, 1985). The system has the following structure:

$$IF \ x \text{ is } A \ \text{and} \ y \text{ is } B \ \text{THEN} \ f = px + qy + r \quad (6)$$

where p , q , and r are constant parameters. The model is suitable for approximating a large class of non-linear systems. For our case, the fuzzy rules are purely constructed from data without any expert's knowledge acquisition. In this case, the fuzzy rules are designated a priori and the parameters of the membership functions are adapted during the learning process from input to output data using a hybrid neural network. The neural net defines the shape of the membership functions of the premises. Figure 5-Left shows an example of the unsupervised construction of fuzzy rules and Figure 5-Right the corresponding neural network that participates in this construction.

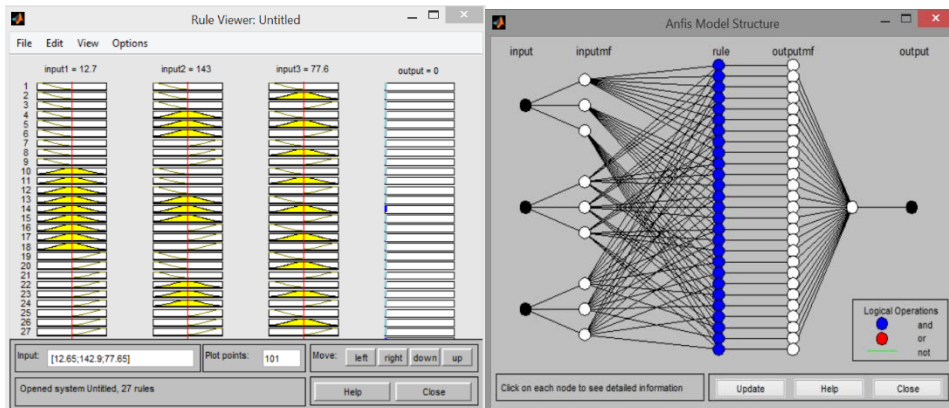

Fig. 5 Left) Fuzzy rule viewer for the case of the 3-3-3 trapmf membership function. Right) The corresponding 5-layer neural network that participates in the construction of the fuzzy rules.

For the learning/training part, the system uses two passes in the hybrid learning procedure. In the forward pass of the hybrid-learning algorithm, the system forces the functional signals of the neural network to go forward till layer 4. At this point, the consequent parameters are identified by the least-squares estimate. We then move to the backward pass, where the error rates propagate backward and the premise parameters are updated by the gradient descent. In our case the parameters are fixed, for both combinations 3-3-3 and 2-2-2. Thus for both cases the overall output is expressed as a linear combination of the consequent parameters. Table 1 depicts all the results taken after running 5 simulations with the combination 3-3-3 and another 5 simulations with the combination 2-2-2.

Number of Membership Functions: 3-3-3 Linear						Optimization: Hybrid/Back			
MFT	NN	NLP	NNLP	TNP	NTDP	NCDP	NFR	RMSE	MAPE
trimf	78	108	27	135	303	131	27	133.41975	16.6720
trapmf	78	108	36	144	303	131	27	4.78881	2.10136
gbelmf	78	108	27	135	303	131	27	13.67616	3.05041
gaussmf	78	108	18	116	303	131	27	8.80895	2.26571
gauss2mf	78	108	36	144	303	131	27	6.85502	2.35748
Number of Membership Functions: 2-2-2 Linear						Optimization: Hybrid/Back			
MFT	NN	NLP	NNLP	TNP	NTDP	NCDP	NFR	RMSE	MAPE
trimf	34	32	18	50	303	131	8	6.61821	7.01869
trapmf	34	32	24	56	303	131	8	6.95011	2.26861
gbelmf	34	32	18	50	303	131	8	4.12944	1.92513
gaussmf	34	32	12	44	303	131	8	4.69009	2.04586
gauss2mf	34	32	24	56	303	131	8	5.74805	2.17019
MFT = Membership Function Type NN = Number of Nodes NLP = Number of Linear Parameters NNLP = Number of Non-Linear Parameters TNP = Total Number of Parameters					NTDP = Number of Training Data Pairs NCDP = Number of Checking Data Pairs NFR = Number of Fuzzy Rules RMSE = Root Mean Square Error MAPE = Mean Absolute Percentage Error				

Each set of the 5 runs correspond to the use of the trimf, trapmf, gbelmf, gaussmf and gauss2mf membership function types respectively. The table contains information of the number of fuzzy rules used for each case and the use of linear and non-linear parameters. For each case, the RMSE and the Mean Absolute Percentage Error, (MAPE) was calculated. The results show that, the best approach for the hybrid combination of 3-3-3 is the use of the trapezoid membership function with RMSE=4.78881 and MAPE=2.10136.

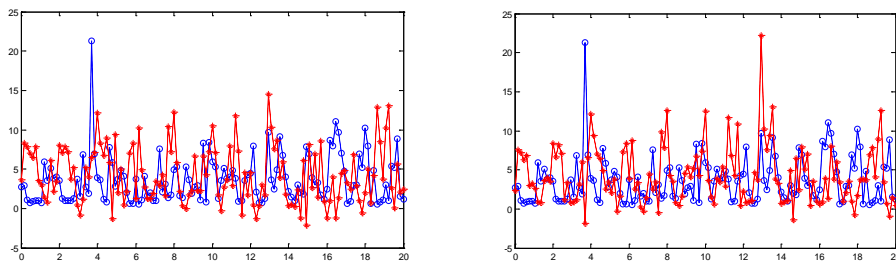

Fig. 6 Left) Observed and predicted time series with the 3-3-3 trapmf membership function configuration. Right) Observed and predicted time series with the 2-2-2 gbelmf membership function configuration.

On the other hand, the best approach for the hybrid combination of 2-2-2 is the use of the gbel membership function with RMSE=4.12944 and MAPE=1.92513. Based on RMSE results both indicated cases perform roughly equally in the range of average 5% error from the observed values. Figure 6 shows the predicted values of the groundwater recharge (red curve) against the observed (blue curve) for the two cases.

Conclusion and Future Challenges

In this work, we presented a novel approach in predicting the groundwater recharge of a watershed using temperature, precipitation and evapotranspiration time series data. The methodology uses an ANFIS where 70% of the available data participates in the learning process with the rest for testing the predicted values against the observed. The results are very promising reaching an almost 5% deviation from the observed values. We plan to model a similar technique for forecasting but with the use of Adaptive Neural Networks and Bayesian Neural Networks. We strongly believe that a combination of the three methodologies can provide a new and useful tool for hydrologists and modelers in managing water resources in a watershed.

Acknowledgement

This research has been co-financed by the European Union (European Social Fund - ESF) and Greek national funds through the Operational Program "Education and Lifelong Learning" of the National Strategic Reference Framework (NSRF) - Research Funding Program: ARCHIMEDES III: Investing in knowledge society through the European Social Fund.

References:

- Adriaenssens, V., De Baets, B., Goethals, P.L.M, and N. De Pauw. (2004). Fuzzy rule-based models for decision support in ecosystem management. *The Science of Total Environment* 319, 1-12.
- Allison, G.B. and Hughes, M.W., (1978). The use of environmental chloride and tritium to estimate total recharge to an unconfined aquifer. *Australian Journal of Soil Research* 16 (2) pp. 181–195.
- Azadeh, A., Saberi, M., Anvari, M., Azaron, A., and Mohammadi, M., (2011). An adaptive network based fuzzy inference system–genetic algorithm clustering ensemble algorithm for performance assessment and improvement of conventional power plants. *Expert Systems with Applications* 38, pp. 2224–2234.
- Gerner, A., (2013). A novel strategy for estimating groundwater recharge in arid mountain regions and its application to parts of the Jebel Akhdar Mountains (Sultanate of Oman). Phd Thesis.
- Harbaugh, A. W., Banta, E. R., Hill, M. G., (2000), MODFLOW-2000, the U.S. Geological Survey Modular Groundwater Model: User guide to modularization concepts and the ground-water flow process, U.S. Geological Survey, Open – File Report, 00-92, USA.
- Jang, J.S.R., (1993). “ANFIS: Adaptive-network-based fuzzy inference systems. *IEEE Trans. Syst., Man, Cybern.*, 23, pp. 665–685.

- Jang, J.S.R., Sun, C.T., and Mizutani, E., (1997). *Neuro-Fuzzy and Soft Computing*. Prentice Hall. ISBN 0-13-261066-3, 607p.
- Khoshnevisan B., Rafiee S., and Mousazadeh H., (2014). Application of multi-layer adaptive neuro-fuzzy inference system for estimation of greenhouse strawberry yield Measurement 47, 903–910.
- Loukas, A., Mylopoulos, N. & Vasiliades L., (2007). A Modelling System for the Evaluation of Water Resources Management Scenarios in Thessaly, Greece. *Water Resources Management*, Vol 21. Pp. 1673 – 1702.
- Maiti, S., and Tiwari, R.K., (2014). A comparative study of artificial neural networks, Bayesian neural networks and adaptive neuro-fuzzy inference system in groundwater level prediction. *Environmental Earth Sciences*, Volume 71, Issue 7, pp. 3147-3160.
- Sen, Z., (2001). *Fuzzy Logic and Foundation*. Bilge Kultur Sanat Publisher, Istanbul. ISBN 9758509233, 172p (in Turkish).
- Sidiropoulos P., Folia S., Mylopoulos N., and Loukas A., (2008). A Coupled Surface Hydrology-Lake-Groundwater Modeling Framework for the Lake Karla Basin, Proceedings of the International Conference "Protection and Restoration of the Environment IX", Kefalonia, Greece.
- Singh, R., Kainthola, A., and Singh, T.N., (2012). Estimation of elastic constant of rocks using an ANFIS approach, *Applied Soft Computing* 12, pp. 40–45.
- Takagi, T., Sugeno, M., (1985). Fuzzy identification of systems and its application to modeling and control. *IEEE Transactions on Systems, Man, and Cybernetics* 15, 116–132.
- Talei, A., Chua, L.H.C. and Quek, C., (2010). A novel application of neuro-fuzzy computational technique in even-based rainfall-runoff modeling. *Expert Systems with Applications* 37, 7456-7468.
- Umamaheswari, R., and Kalamani, D., (2014). Adaptive Neuro Fuzzy Inference System for Monthly Groundwater Level Prediction in Amaravathi River Minor Basin. *Journal of Theoretical and Applied Information Technology*, Vol. 68, No.3, pp. 523-530.

ENVIRONMENT, WATER AND TERRITORY: DIAGNOSIS AND METHODOLOGICAL ANALYSIS OF WATER RESOURCES MANAGEMENT IN A WATERSHED OF HIGHLANDS OF JALISCO MEXICO

Aldo Antonio Castañeda Villanueva, Prof. M.S

Universidad de Guadalajara, México

Cándido González Pérez, Dr.

Departamento de Estudios Organizacionales,
Centro Universitario de Los Altos, México.

Raymundo Velasco Nuño, Dr.

Departamento de Ciencias Biológicas,
Centro Universitario de Los Altos, México.

Abstract

For the management of natural resources, one option is integrated partial management of small watersheds; specifically the local management of water bodies as amalgam both bio-physical, socio-cultural elements, such as falling within the watershed itself. In the present work advances in the diagnosis and methodology of the research project on the quality and availability of water resources in the watershed of "Jihuite" and its interrelation with the growth of the city of Tepatitlán, Jalisco exposed, because of the change on land use, population growth and agricultural and industrial development of the region in the last 25 years. The watershed of the Jihuite is located 6 km from the city of Tepatitlán, belongs to the sub-basin of the Rio Verde, the Santiago basin and the hydrologic region Lerma-Santiago-Pacific, with an area of approximately 60 km². By the methodological approach of Cultural Ecology and various quantitative and qualitative stages, such as parametric data collection on quality and degree of availability, statistical techniques (principal component analysis) and the use of participatory geographic information systems, as well as interviews, surveys and field trips local uses and handling of water bodies were addressed, by the different users of the watershed, identifying strengths and weaknesses of the current program for local water management, in order to promote local management alternatives that offer greater certainty and sustainability of the resource.

Keywords: Water management, El Jihuete watershed, Highlands of Jalisco

Introduction

With the passing of time, humanity in its procurement of food and shelter, has changed and impacted the surrounding environment, in recent years these effects have been critical to the extent that some of these changes in terrestrial nature are difficult reverse like; environmental pollution, global climate change and significant decrease in the productivity of ecosystems. Man uses large amounts of water for their daily personal activities, but much more to produce food, paper, clothing and other products it consumes. The water footprint (WF) of a country is defined as the total volume of water used to produce the goods and services consumed by its inhabitants,, the concept of WF was introduced to provide information on water use by different sectors, the production of some food demand more water than others, while some industrialized products, such as paper, may require the use of large amount of water for their production, the amount of water used in the production of each product is referred virtual water content, Globally 86% of the WF is related to the consumption of agricultural products, 10% with consumption of industrial goods and less than 5% with household uses, the main factors that determine a country WF are: a) average water consumption per capita, related to gross national income, b) consumption habits of its inhabitants, c) climate, particularly evaporative demand and d) agricultural practices. In the period 1997-2001, more WF countries were the United States, Greece and Malaysia (Figure 1), up from 2,300 m³/person/year; in contrast, Afghanistan and Somalia have a water footprint per capita less than 700 m³ /person/year. In the same period, Mexico had a WF per capita of 1,441 m³/person/year (Chapagain et al., 2004).

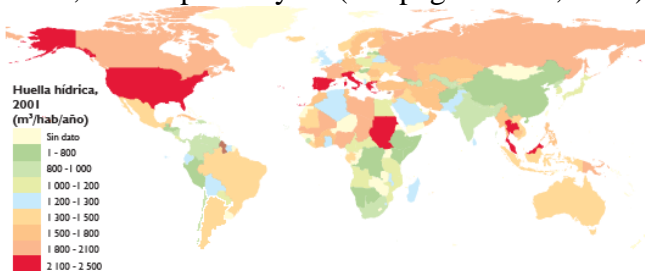

Fig. 1: Water footprint in the world.

Water is an essential for the overall development of human populations need, however is no longer an abundant and available resource quantity and quality. In Mexico the increased demand for water for agricultural use (88%), followed by the municipal (5%), industrial (7%) and without considering energy generation; on the one hand, this has led to

overexploitation, and secondly, pollution of our water resources (CNA, 2008). Therefore, local governments and users face an enormous challenge to design and implement new models of integrated river basin management to ensure the quality and supply of water to their communities and future generations (UNDP, 2006), which is included citizen participation in designing policies and agreements that promote sustainable water management, as the case of "the new water culture". During the last 20 years of the twentieth century, with the dependence on water extracted from deep wells, some with more than three hundred meters, the population of these regions has changed their practices, so that runoff water from rivers and streams passed to be on the surface drains. At the beginning of XXI century is consolidated in the region competition for water with large cities, but also with industry, agriculture and livestock (Barkin, 2005).

The territory of Highlands of Jalisco is divided into two regions: Highlands-North and Highlands-South; the first with a total area of 8882.23 km² (11.08% of the area of the state), the depth of the deep wells for the extraction of water in this region is about 200 meters on average, except for the municipalities of Ojuelos and San Diego de Alejandria where the depths are 300 and 400 meters, and Highlands-South with an area of 6677.36 km² (8.33% of the surface of the state), both regions are located in the hydrologic region 12 "Lerma-Santiago". The Highlands-South region presents an aquifer defined in Acatic-Tepatitlán-Arandas area with an approximate area of 6,000 km², same as for its geo-hydrological characteristics is widely exploited, especially the municipalities of Tepatitlán and Arandas, varying depths wells in the area between 200 and 500 meters. The sources of water pollution in these regions are directly related to the socio-economic activities taking place in each area, in general livestock farms (pork, poultry and livestock), seasonal agriculture and processing industry dominated growing (meats, dairy, tequila, etc ...), referring the cattle inventory in Mexico (Jalisco and Highlands of Jalisco) the following amounts (Table 1) are reported:

Table 1: Livestock Inventory. Based on data from INEGI 2012

	México	Jalisco	Highlands of Jalisco
Bovine milk	2 340,903	311,779	189,184
Bovine meat	29 420,059	2 661,779	105,700
Pork	15 230,631	2 595,303	1 396,738
Laying hens	184 711,880	83 901,202	73 556,730
Poultry meat	311 961,857	33 711,220	13 235,625

Reflecting the importance of the Highlands area, both in domestic livestock production, as in the generation of organic waste and wastewater, as evidenced by the high degree of eutrophication of water bodies that serve as regional livestock troughs and dam reservoirs, used as drinking water for

towns like Tepatitlán (Ramirez et al., 1997). As Secretary of the environment and social development of the state of Jalisco (SEMADES, 2006), says that all municipalities of the Highlands of Jalisco have problems of pollution of surface water, pouring untreated wastewater to the river network and farm wastes. The farming systems have also been identified as sources of nonpoint pollution to surface water bodies (Flores et al., 2009). More dramatic is the situation in which these contaminated the water resources Highland region is planned for use in cities like Guadalajara in Jalisco and Leon in Guanajuato. In Highlands-South and Highlands-North regions problems of overexploitation of aquifers (CNA, 2006), accentuated by the extraction of deep groundwater with high fluorine content (Hurtado & Gardea, 2005), with the consequent negative effect on health report population and declining water for human consumption (Figure 2). The impact of climate change on natural resources, particularly water, in the last four years, has already shown devastating effects, such as modifying the distribution of rainfall, which in 2003 caused flooding in Tepatitlán, in 2006 the loss a wide area under crops in the region and in general in the state of Jalisco the main factors that relate to the two types of pollution are: 1) the excess of nutrients contained in the food consumed and excreta; 2) the output of nutrients and suspended solids via surface runoff; 3) soil physicochemical processes associated with phosphorus and nitrogen nutrients; 4) the management of manures; 5) The erosion in grazing areas; 6) the residual long-term effect of continuous application of manure; 7) the intensity of grazing or overgrazing; and 8) the proximity of grazing animals to water currents and dramatic perspective of water in the Hihglands region of Jalisco, makes it imperative to implement actions for the conservation of natural resources.

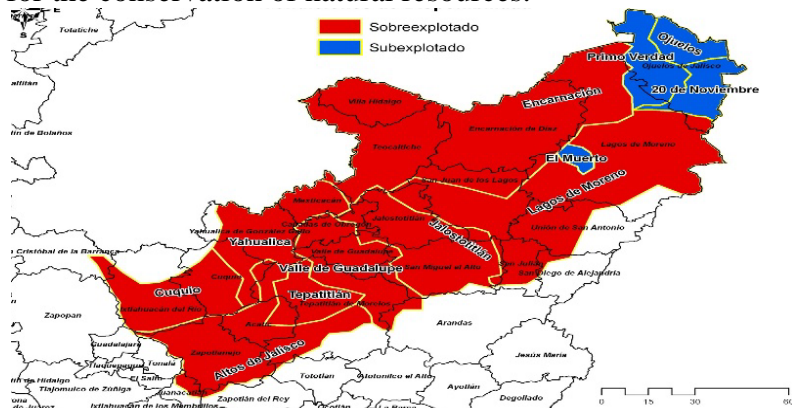

Fig. 2: Location of aquifers in Highlands of Jalisco. Source: CEAJALISCO, 2014

Study area: Tepatitlán is located on the old colonial way with the aim of controlling the silver that was transported from Zacatecas to Mexico City, east of Guadalajara. In 1940 he finished the paving of the road, which

prompted the regional productive extraction, particularly milk, ensuring military control of the area. It was here that the federal government suffered a defeat against the Highlanders ranchers during the rebellion known as "Cristiada", between 1926 and 1929, during this period there was an unprecedented increase in the number of settlers mainly due to re-concentration campaigns bound by the federal government and Tepatitlán had to give asylum to a large number of people, if 8,000 people lived in the city in 1920 to 1927 had to be concentrated 25,000 people, but this increase in population walks parallel to the demand for water. This is the time in the history of the city in which a transformation is experienced. The city life starts changing forms of water management and this will also be important for change, unseen short term, culture regarding water management (Casillas, 2013). Agricultural and forest watershed "The Jihuite", is located in the town of Tepatitlán, northeastern state of Jalisco (Figure 3), is geographically located between latitude $20^{\circ}50'57''$ and $20^{\circ}55'50''$ N and $102^{\circ}36'50''$ meridians and $102^{\circ}43'W$, at an altitude of 1900–2150 meters, with an area of about 5,900 hectares, the climate is sub-humid temperate. The average annual maximum, minimum and average temperature is 25.6, 7.6 and $16.6^{\circ}C$, respectively. The annual average rainfall is 816.3 mm. (Flores, et al., 2012). The topography of the basin is hilly with slopes of 1-58% (INEGI, 2008), most of the floor of the watershed is luvisol iron, clay or clay loam texture, depth of one meter, another type of soil that occurs in the northern part is the eutric planosol, clayey with depth of 40 centimeters or less. Land use indicates that about 30% of the area is devoted to annual crops, 10% temporary grassland, rangeland 55% to 5% native species used with roads, buildings and other uses. The ownership of land is the small property.

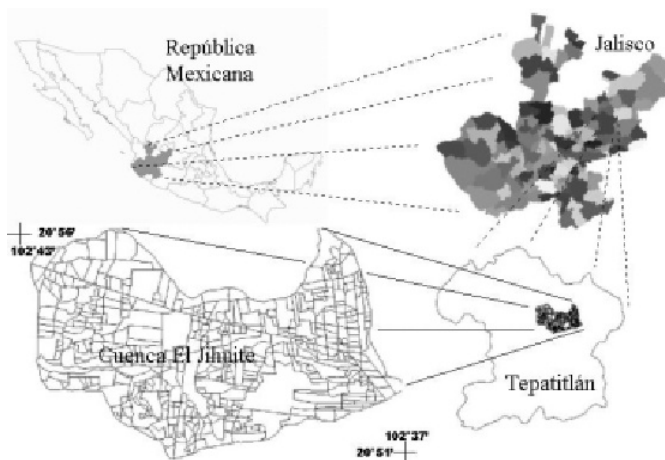

Fig. 3: Location of the watershed "The Jihuite".

The growth in agricultural and industrial activities in Highlands of Jalisco, represent an important supply of raw materials and basic foodstuffs for both the region itself and to other parts of the country, however, these activities affect the sustainability of natural resources water. The extent and boundaries of the watershed was performed using digitized aerial photographs, resulting in an area of 5850.63 hectares, over 53.97 acres of the reservoir of the dam for a total of 5904.6 hectares (Figure 4).



Fig. 4: Total area and land use in the watershed "The Jihuite".

Cultural ecology and borders

Cultural ecology (CE) had born within social anthropology, as concepts, theoretical and methodological theory of cultural change of Julian Steward contributions. For over 130 years, analyzes of the relationship between nature and culture or nature and society, permeate the reflections of anthropologists and Geertz states that environmental factors define the cultural manifestations and that all societies in the world would pass no excuses through the same stages of socio-cultural development, but seemed unaware of the influence of the environment on cultural advancement, however, Boas early twentieth century, showed the existence of deep cultural differences between communities, including people whose habitat was similar, at what Leslie A. White call "basic law of evolution of culture" than to support a story of cultural development, with a universal taxonomy thereof, stating the existence of almost universal parallels in adaptation processes environment and thus establish general levels of cultural development, according to the CE Steward "presents a problem and method", the question lies in whether human adaptations to their environments societies require particular ways behavioral, or cease freedom for certain kinds of possible behaviors". Conceptions of Frederick J. Turner that the boundary born", at the edge of the empty land and is primarily a frontier settlements, an ever-moving line that marks the advance of civilization", the same way; "That cultural system that best exploits the environmental resources necessary, will tend to expand in such a medium, at the expense of

less effective systems", with this approach the expansion or contraction of the border is explained in terms of the technological capacity of groups human (Fabregas, 2003). On the other hand Barth discusses how ethnic boundaries to a defined group of people, which are purely social and can not be territorial, ethnic boundary is located at the margins of culture of a people and their forms of social organization, but constitute its core, "the border is not on the shore but in the center," concludes that ethnic boundaries are maintained through a specific set of cultural characteristics, the persistence of the group depends on the continuity of these features, while the change is allowed precisely those features that are not involved in the definition of the border. In general, a boundary is created from human activity, of encounters and clashes with their own history and that of others, is modeled and transformed by the activity and growth of human group or for the consequences of their dominance over another group, so Fabregas and took from the CE proposed a comprehensive anthropology able to cover the multidimensionality of society and culture, this method requires maintaining the importance of empirical dimension without losing sight of the theoretical development and in terms of studies of regions and borders, long-term vision is the most important in monitoring changes empirical and theoretical elaboration. The regions or borders are a result of not only specific but changing human experiences. In CE each society "uses an adaptive strategy to manage their environment, exploit it to their advantage and ensure continuity of society itself, so essential to analyze the historical moment of adaptation and its particular context" (Fabregas & Tomé , 2002). The CE brings us to the relationship of a company with its environment, how access to basic resources and the historical process of forming regions is controlled, in this context, technology is a factor of prime importance in any adaptation process (Henry Morgan) and the concept of low border this approach, is created when a natural environment is transformed into culture and introduced into the historical trend. Borders are spaces for relations between different CE and its historical dimension is crucial, are changing for the regions, in constant motion that generates social and cultural diversity.

The CE study region in Mexico

Several works of Manuel Gamio (1922) and Jorge A. Vivo (1951) point out the importance of understanding the natural environment in the analysis of a culture or society, Gonzalo Aguirre Beltrán (1950-1969) emphasized the preponderance of the environment and the interrelationship that human groups establish with him, to understand the formation and configuration of regions. The CE was contextualized theory in Mexico, thanks to the efforts of Angel Palerm and Eric Wolf (1954-1955), especially for analyzing ethnohistory of the central Mexico Palerm related Marxist

discussion about Asian Production Mode (APM) with the approach of Wittfogel around the eastern society and the method of the CE, to apply to ethnohistorical study of the Valley of Mexico (Acolhuacan area at Texcoco State of Mexico). The hydraulic society proposed by Krader (1975) who argues that it is not technology that gives its nature to society, anyway hydraulic technology is part of an adaptation strategy involving a basic factor to control water in the process food production. Wittfogel chose technological determinism in an environment that requires control of water to make production possible. Palerm aligning with Wittfogel established the existence of the "Hydraulic society" in the Valley of Anahuac. Brigitte Boehm (1986) identifies both Mesoamerica as a "cultural area" with associated bureaucracies that managed public affairs, such as the establishment of the State in prehispanic Mexico, the Wittfogel himself included Mesoamerica as a "marginal area" of "oriental despotism", due to the importance of public water control works that existed in the Valley of Anahuac, conceived and executed by the State.

Jalisco and his Highlands

Fabregas argues that in the case of the historical process of formation of the Highlands of Jalisco, more important than the extent of the land and its productive capacity, was the existence of an agricultural economy subordinated to mining allowing capital accumulation and lie smallholders produced "for consumption", the colonial oligarchy could transform the cream of the crop in goods, to acquire these goods by the rest of the population, was necessarily mediated by the existence of low wages that complemented the household production, this control of the oligarchies on goods, resulted in increased debts of smallholders, and therefore increasing wage dependency, consolidating the division of labor that unbalance the family economy and seated structures in this. By sacrificing the rural economy, the family stopped being production unit to become mere reservation of labor, therefore mechanism lowering of wages, poor smallholders became tenants or sharecroppers, having to sell their land, generated the predominance of large properties. In this scenario locale of Highlands area, show that "the abundance or scarcity of land and its specific use" was completely determined by the social relations of production around social work "(Fabregas, 1986). Take argues that this shows that the CE must necessarily include political processes in environmental explanations (the relationship between economics, politics and society contribute more to configure the regional boundaries, the components themselves of the natural structure of the environment as watershed).

Panoramic and next

Certainly one of the major social challenges worldwide is appropriate and responsible use of natural resources such as water management, as its proper utilization depends not only from government policies but also necessarily the decisive participation of society, and that the better the situation of water resources, more timely supply in quantity and quality to ensure future generations understand it.

The diagnosis indicates that the quality of water bodies in the watershed under study, mainly from the dam, has deteriorated, mainly due to agricultural and industrial activities take place there; on one side are maize, sorghum and agave that on fertilized cause the hydraulic drag of nutrients, and the other discharges untreated wastewater from livestock farms and industries, resulting in the dam, a high concentration of nitrogen, phosphorus and organic matter encourage algae growth and decreased dissolved oxygen. Similarly denoted a marked variation in the pattern of rainfall in the watershed that directly affects both the surface intakes, and the natural recharge of the aquifer, causing sensitive diminutions in dynamic levels in deep water extraction wells.

In the later stages of the investigation and the approach of Cultural Ecology method of qualitative techniques were developed through field trips in the watershed to investigate the forms of local water management and perceptions of different stakeholders. Comparing the results with statistical and parametric analysis of quality and availability to set short- and medium-term sustainability scenarios.

References:

- Barkin, D. La gestión del agua urbana en México: Retos, debates y bienestar, Universidad de Guadalajara. México, 2005.
- Casillas, M. La tercera revolución del agua: Urbanización, gestión y contaminación del agua: El caso de Tepatitlán de Morelos Jalisco, México, durante el siglo XX. Revista Agua y Territorio Núm. 1 (Enero-Junio), Jaén España, 2013.
- Casillas, M. y González, C. Del campo a la ciudad, reflexión en torno a la gestión del agua en Los Altos de Jalisco, 2010.
- Chapagain, A. y Hoekstra, A. Water footprints of nations. Value of Water, Research Report Series No. 16, UNESCO-IHE. Delft. The Netherlands, 2004
- Comisión Estatal del Agua-Jalisco, CEA-Jal. Datos y Estadísticas por Cuenca Hidrológica; http://www.ceajalisco.gob.mx/cuencas_prioritarias.html, 2011.
- Comisión Nacional del Agua. CNA. Situación del subsector agua potable, alcantarillado y saneamiento. Comisión Nacional del Agua 2006.

Comisión Nacional del Agua. CNA. Estadísticas del agua en México sobre sequía, México, 2008.

Comisión Nacional del Agua. CONAGUA. Sistema nacional de información del agua (SINA). México 2013.

Comisión de Planeación para el Desarrollo del Estado de Jalisco. COPLADE. Agenda para el desarrollo regional: Región 03 Altos-Sur: <http://capturportal.jalisco.gob.mx/wps/wcm/connect/a81520804dbe31289df1fd5160bedb77/03+Agenda+Regional.pdf?MOD=AJPERES&CACHEID=a81520804dbe31289df1fd5160bedb77>, 2004.

Fábregas, A. La formación histórica de una región: Los Altos de Jalisco, México. CIESAS ediciones de la casa Chata. México, 1986.

Fábregas, A. La ecología cultural política y el estudio de regiones en México, en Revista de Dialectología Tradiciones Populares vol. LXIV, núm. enero-junio, México 2009.

Flores, H., *et al.* Aportes de nitrógeno y fósforo de tres sistemas agrícolas de la cuenca hidrográfica de El Jihuite, en Jalisco, México. Revista Agrociencia Núm. 43 México, 2009.

Hurtado, R. y Gardea, J. Estimación de la exposición a fluoruros en Los Altos de Jalisco, México". Salud Pública de México, 47(1), México, 2005.

Instituto Nacional de Estadísticas y Geografía INEGI. <http://www.inegi.org.mx/geo/contenidos/imgpercepcion/default.aspx>, 2012.

Palerm, A. La distribución del regadío en Mesoamérica. Ciencias Sociales. Washington, D.C., Unión Panamericana, Departamento de Asuntos Culturales, Oficina de Ciencias Sociales, Vol. V, Núm. 25, 1952.

Palerm, A. y Wolf, E. El desarrollo del área clave del imperio texcocano. Revista Mexicana de Estudios Antropológicos 14, México 1955.

Palerm, A. y Wolf, E. Agricultura y civilización en Mesoamérica. México: Sep- Setentas, 1972.

Peniche, S. y Guzmán, M. "La gobernanza del agua en Jalisco", en Gobernanza y gestión del agua en el occidente de México: La metrópolis de Guadalajara. Colección Alternativa al desarrollo Ed. ITESO, coordinadores: OCHOA/BURKNER Guadalajara México, 2012.

Programa hídrico visión 2030 del estado de Jalisco http://www.ceajalisco.gob.mx/pdf/phej_2030.pdf

Ramírez, H., *et al.* "Informe socio-económico de la cuenca del Jihuite". INIFAP manejo integral de la cuenca agropecuaria y forestal del Jalisco, 1996.

Secretaría del Medio Ambiente y Desarrollo Social, SEMADES <http://semadet.jalisco.gob.mx/desarrollo-territorial/sistema-de-informacion-territorial>, 2006.

Secretaría del Medio Ambiente y Recursos Naturales, SEMARNAT

http://www.semarnat.gob.mx/informacionambiental/Documents/pdf/cap_1_poblacion.pdf, 1996.

Stewart, J. Theory of cultural change: the methodology multilinear evolution, Urban University of ILLINOIS Press USA, 1995.

Tomé, P. Antropología ecológica; influencias, aportaciones e insuficiencias” Ávila; Institución Gran Duque de Alba, España, 1996.

Tomé, P. y Fábregas, A. Entre parientes, Zapopan. El colegio de Jalisco, México 2004

United Nations Development Programme (UNDP). Informe sobre Desarrollo Humano: Más allá de la escasez: Poder, pobreza y crisis mundial del agua, <http://hdr.undp.org/es/content/informe-sobre-desarrollo-humano>, 2006.

“AN APPLIED RESEARCH TO SUPPLY ENERGY COMING FROM EXPLOITATION OF BIOMASS SCRAPS TO “LITTLE AND MIDDLE ENTERPRISE (LME)” (PART ONE)

Prof. Eng. Francesco Patania

Prof. Eng. Antonio Gagliano

Prof. Eng. Francesco Nocera

Department of Industrial Engineering (DII) of Catania University (Italy)

Eng. Agrifoglio Antonio

Independent researcher

Abstract

The research was funded by “Operative National Plan - European Capital for Regional Development” (PON-FERS 2007-2013, Industry 2015). Authors considered the Sicilian LME producing wastes from operational processes as like woody chips, wood shavings, shells of hazelnut or almond and so on. A previous survey carried out on a consistent sample of Sicilian LME showed that electrical power required by operational processes ranges substantially around three main values (250, 500 and 635 kW_e) and research was addressed to obtain previous values of electrical power. People takes in consideration the exploitation of biomass through pyrolysis process since it produces syngas usable as fuel in gas-turbine of CHP plant, bio-oil and bio-char too, both of them able to supply thermal energy to many section of plant.

The whole paper describes the general plane of research and guidelines for:

- calculus of sizes of biomass stockpile storage (storage and drying - first section)
- design of equipments of pyrolysis process and exhausts treatment (pyrolysis process – second section)
- design of cogeneration system (CHP techniques – third section).

The result of research specifies too the economical decreasing of operational costs of LME and the remarkable environmental benefits arose by exploitation of biomass.

For room reason the part one of paper describes the generalized characteristics of research and results of calculations to design drying and storage section.

Keywords: Biomass, Pyrolysis, Energy, CHP, Enterprise

Research

Aim of research is production of syngas through a “pyrolysis process” fed by residual biomass from manufacturing of LME. Syngas supplies a gas turbine of a CHP system to produce electrical power required by operational cycles of LME (250, 500, 600 kW_e).

Steam at low pressure obtained through heat exchanges with exhaust of turbine feeds pyrolysis reactor.

Steam is utilized too, through heat exchange with external air, to produce hot air to remove moisture content in biomass.

Fig.1 shows a schematic flow-diagram of all operational paths of process.

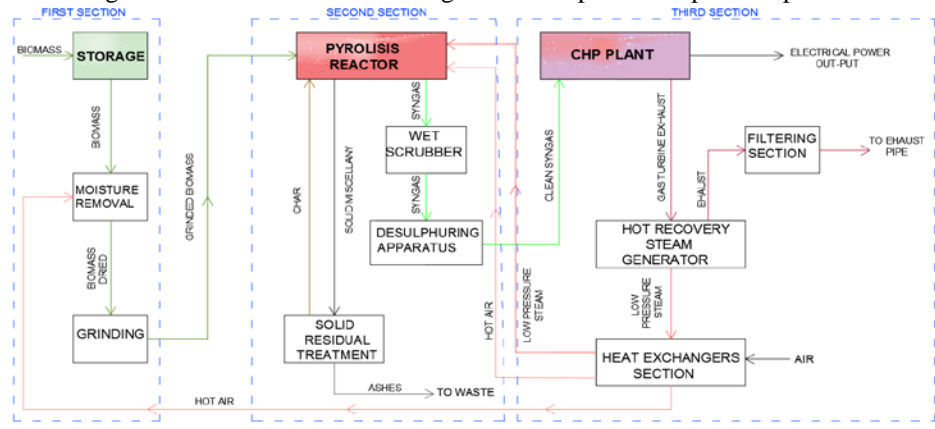

Fig.1

Types of chosen biomass and influencing parameters

Nowadays exploitation of biomass to produce biofuel through various processes (Tab.1) provides to about 15% of world energy request.

	<i>PROCESS</i>	<i>PRODUCTS</i>
THERMOCHEMICAL PROCESSES	COMBUSTION	THERMAL ENERGY
	GASIFICATION	SYNGAS
	PYROLYSIS	SYNGAS
		BIO-OIL BIO-CHAR
BIOLOGICAL AND CHEMICAL/PHYSICAL PROCESSES	FERMENTATION	BIOETHANOL
	TRANS-ESTERIFICATION	BIODISEL
	SQUEEZING AND FILTATION	VEGETAL GAS
	ANAEROBIC DIGESTION	BIOGAS

Tab.1: Synthetic table of main biomass conversion : processes and products

Speaking about biomass, people may refer to any substance including carbon in its chemical structure derived, in direct or indirect manner, by photosynthesis process.

The substances in fossil form are kept out since out of purpose of research.

The biomass scraps from investigated LME suitable for research are coming from:

- Agro-industrial:

The resulting of wasted matter from manufacturing of olive oil, wine, almond, hazelnut and walnut (olive pits, shells, etc., etc.);

- Manufacturing of woody objects as furniture etc., etc. (woody shavings, scraps and remnants).

Fig.2 shows the main paths to obtain biofuel from biomass.

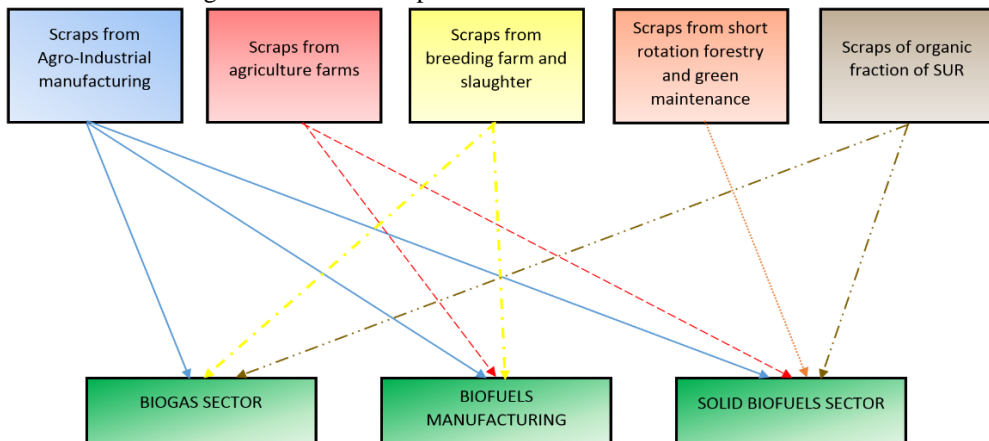

Fig.2: spinneret of biomass

Even if characteristics of biomass are very variable due to large number of substances so called, there are some parameters quite important for our purposes as like content of moisture (R_M) and lower heating power (**LHP**) of each biomass.

As regard moisture of biomass, naming m_w the mass of water contained in the whole and m_d the mass of dry substance, the moisture content (u) on wet basis is given by formula (1).

$$(1) \quad u = m_w / (m_w + m_d) \quad (\text{theoretically } 0 \leq u \leq 1)$$

Formula (2) instead gives the moisture content on dry basis (u_0)

$$(2) \quad u_0 = m_w / m_d \quad (\text{theoretically } 0 \leq u_0 \leq \infty)$$

Ratio $R_M = (m_w + m_d) / m_d = 1 + u = 1 / (1 - u)$ is important as regard the evaluation of cost of operations since it is representative to know the increased quantities of biomass as such to collect, transport and store per unit of dry matter.

In function of humidity content, practically R_M ranges between value 2 ($u=50\div55\%$) and value 5 ($u=75\div80\%$).

As regard low heating power (**LHP**), taking in account that usable energy relative whole mass of substance as such (dry + water) is given by chemical energy of dry matter decreased the heat of vaporization of water, it is possible to write formula (3)

$$(3) \quad (m_w + m_d) \cdot LHP = m_d \cdot LHP_0 - m_w \cdot r$$

where:

- LHP_0 = Low heating power of dry substance
- r = heat of vaporization of water

From a practical point of view, being the quantity of water in substance as such equal to “x time” the quantity of hydrogen (H) present in substance, the formula (4) gives

$$(4) \quad LHP = LHP_0 - x \cdot H \cdot r$$

Fig.3 is an exemplum of variation of LHP in function of moisture content and kind of biomass in gasification process:

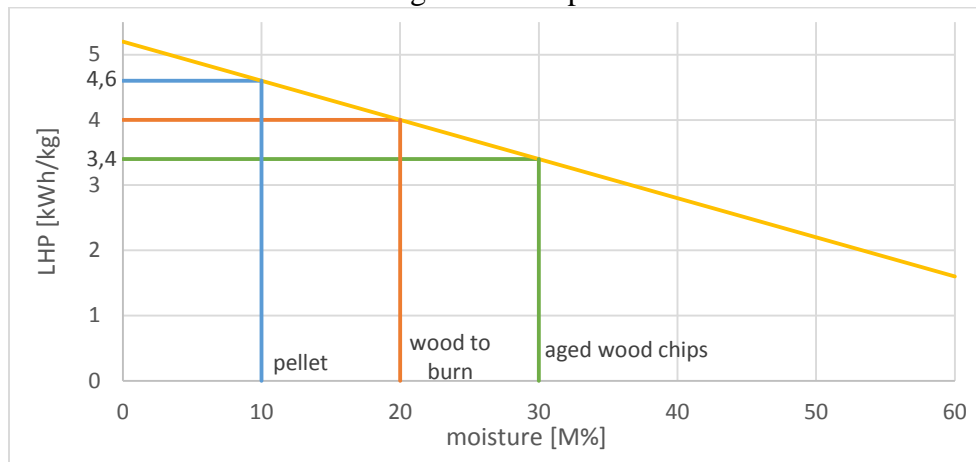

Fig. 3: Trend of LHP of woody matters in function of contents [1]

The process of Pyrolysis

Pyrolysis is a thermodynamics break-down of organic matter at temperatures variable in function of many parameters and in function of pyrolysis the chose.

Tab.2 shows for each kind of pyrolysis characterizing parameters and products of process.

The ranging of parameters depends on type of feedstock and kind of reactor.

<i>PYROLYSIS</i>	<i>AVERAGE RANGING OF OPERATIVE TEMPERATURES [°C]</i>	<i>STAYING TIME [s]</i>	<i>HEATING RATE [k/s]</i>	<i>PRODUCTS % RANGE</i>
SLOW	250÷300	1500÷1800	0.1÷1.0	Bio-char 80÷85 Bio oil <4 Gas 05÷15
INTERMEDIATE	400÷500	10÷30	5÷80	Bio-char 20÷30 Bio oil 45÷50 Gas 20÷30
FAST	400÷500	0.5÷2.0	10÷200	Bio-char 10÷15 Bio oil 65÷75 Gas 10÷15
FLASH	400÷500	0.2÷0.5	500÷1000	Bio-char 15÷25 Bio oil 60÷70 Gas 10÷15
GASIFICATION	900÷1200	0.1	>1000	Bio-char 05÷10 Bio oil - Gas 85÷90

Tab.2 [2]

During pyrolysis process the big chains of carbon (C), hydrogen (H) and oxygen (O₂) of biomass due to temperature are transformed into smaller gaseous molecules (**syngas**), considerable vapors (**tar and oil**) and solid carcoil (**bio-char**).

Fig.4 shows relative proportion of final products in function of temperature of process.

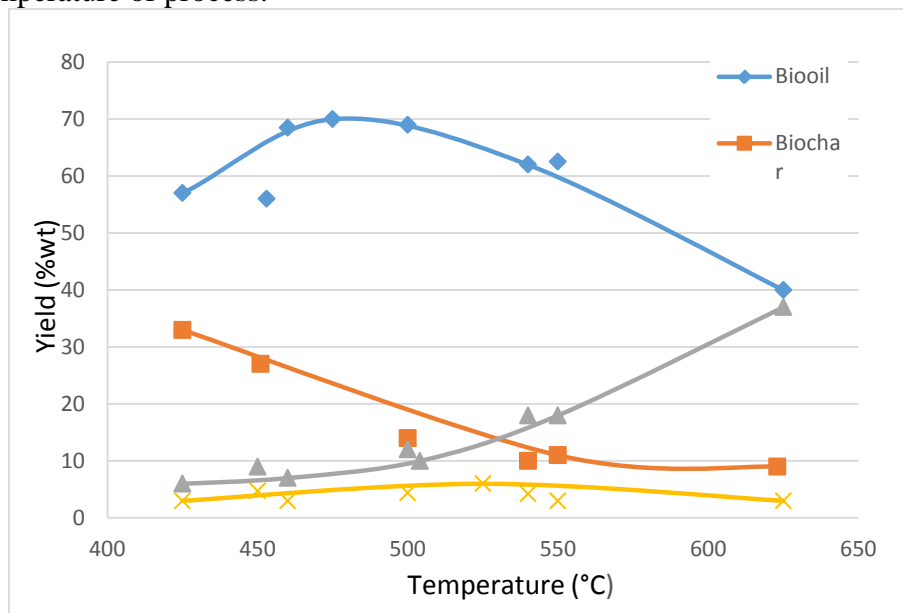

Fig.4 [3]

As regard syngas, aim of research is that it must be used as fuel to supply gas turbine. [4]

Heating power of syngas depends on oxidant agent (Tab.3).

<i>LOW HETING POWER [kJ/Nm³]</i>	<i>OXIDANT AGENT</i>
LOW 4-6	AIR-AIR/STEAM
MEDIUM 12-18	O2-O2/STEAM
HIGH 40	H2

Tab.3

It is true that syngas used as fuel produce about 30% less of engine out-put in comparison with petrol [5] but it owns positive features for LME as saving of coasts of wasted matter removal and lower amount of polluting emission like unburnt hydrocarbons (**HC**) and carbon monoxide (**CO**).

As regard bio-char, it is solid matter highly flammable in presence of air so that many precautions have to be taken during its utilization.

Positive feature of bio-char produced is that it owns energy enough to supply heating break-down of biomass up to required temperatures so that pyrolysis process could be “thermally self-sufficient” (Bridgewater 2012).

4 – One Method to calculate stockpile storage

An experimental plant [6] fed by olive pits, through a syngas turbine produces an average electrical power of 90 ÷ 100 kW.

Fig.5 shows experimental plant.



Fig.5 [6]

Syngas supplying turbine comes from pyrolysis process of plant.

Experimental data of operation of plant point out following results:

- Average flow-mass of olive pits $\dot{m}_{op} = 484.0 \text{ kg/h}$
- Lower heating power (LHP) of olive pits $\text{LHP}_{op} = 4500 \text{ kcal/kg}$
- Average flow-rate of produced syngas $\dot{m}_{sy} = 370 \text{ Nm}^3/\text{h}$
- Average of syngas LHP $\text{LHP}_{sy} = 1480 \text{ kcal/Nm}^3$

From previous experimental data, formula (5) gives the average specific value of consumption ($C_{s_{op}}$) of olive pits to produce $1.0 \text{ Nm}^3/\text{h}$ of syngas:

$$(5) \quad C_{s_{op}} = \dot{m}_{op} / \dot{m}_{sy} = 1.31 \text{ [kg/Nm}^3\text{]}$$

Through (5) and value of LHP_{op} , formula (6) gives amount of Thermal Rate (TR) to produce $1.0 \text{ Nm}^3/\text{h}$ of syngas through olive pits:

$$(6) \quad \text{TR} = C_{s_{op}} \cdot \text{LHP}_{op} = 5,895.0 \text{ [kcal/ Nm}^3\text{]}$$

Tab.4 shows average LHP_i adopted for each considered biomass:

<i>Dry Biomass</i>	<i>Average LHP_i [kcal/kg]</i>
Olive pits	4,500
Wood shavings	3,200
Woody scraps	3,600
Shells of almonds, walnut and hazelnut	4,200
Marc	4,300

Tab.4

Formula (7) gives C_{s_i} for investigated biomass and results are showed in Tab.5:

$$(7) \quad C_{s_i} = \text{TR} / \text{LHP}_i$$

<i>Dry biomass</i>	<i>Abbreviation</i>	<i>Specific Consumption</i>	<i>[kg/Nm³]</i>
Olive pits	op	$C_{s_{op}}$	1.31
Wood shavings	ws	$C_{s_{ws}}$	1.85
Woody scraps	wc	$C_{s_{wc}}$	1.64
Shells	sh	$C_{s_{sh}}$	1.41
Marc	ma	$C_{s_{ma}}$	1.37

Tab.5

Technical bibliography of some companies (PV Power System, ABB, Capstone, etc. etc.) making gas turbines able to produce electrical out-put as required by LME, give the average value of efficiency (η_i) showed in Tab.6.

Formula (8) gives thermal power (P_T) theoretically required to produce electrical power need of LME and Tab.6 shows the results for each required power in function of η_{ti} :

$$(8) \quad P_{Ti} \text{ [kW}_T\text{]} = P_{Ei} \text{ [kW}_E\text{]} / \eta_{ti}$$

$P_{Ei} [kW_E]$	η_{ii}	$P_{Ti} [kW_T]$	$P_{Ti} [Kcal/h]$
250	0.30	834	717,240
500	0.33	1,564	1,345,040
635	0.35	1,815	1,560,900

Tab.6

Formula (9) gives for each electrical power the amount of required biomass (\dot{M}_i) and results are showed in Tab.7 :

$$(9) \quad \dot{M}_i = (P_{Ti} / LHP_{sy}) \cdot Cs_i$$

$P_{Ei} [kW_E]$	$P_{Ti} [Kcal/h]$	<i>Biomass</i>	$LHP_i [kcal/kg]$	$Cs_i [kg/Nm^3]$	$\dot{M}_i [kg/h]$
250	717,240	Op	4,500	1.31	635
		Ws	3,200	1.85	897
		Wc	3,600	1.64	795
		Sh	4,200	1.41	683
		Ma	4,300	1.37	664
500	1,345,040	Op	4,500	1.31	1,191
		Ws	3,200	1.85	1,681
		Wc	3,600	1.64	1,490
		Sh	4,200	1.41	1,281
		Ma	4,300	1.37	1,245
635	1,560,900	Op	4,500	1.31	1,382
		Ws	3,200	1.85	1,951
		Wc	3,600	1.64	1,730
		Sh	4,200	1.41	1,487
		Ma	4,300	1.37	1,445

Tab.7

The volume of stockpile storage depends on the geometrical shape and size of biomass : in fact one cubic meter of storage volume contents greater quantity of “olive pits” compared to “wood shavings” due to more compact shape of “olive pits” that causes smaller empty portion (co-volumes) in whole storage volumes.

To take in account of this factor, people devised the “shape efficiency” (η_f) that takes in account geometrical shape and size of investigated biomass.

The methodology of devising is originated from a geometrically compared processing coming from so named “**mass steri**” of European Norm (EN 14961-5).

The EN 14961-5 prescribes in fact the acronyms to give to various types of woody mass also in function of the volume of biomass that one empty cubic meter can include and in function of average specific volume too.

Tab.8 gives values of η_{fi} devised :

Biomass	$\eta_{fi} [m^3/m^3]$	$\rho_i [kg/m^3]$
Olive pits	0.70	1,100
Wood shavings	0.45	220
Woody scraps	0.55	430
Shells	0.60	600
Marc	0.65	1,060

Tab.8

Taking in account of \dot{M}_i (Tab.7), η_{fi} and ρ_i (Tab.8) , formula (10) permits the calculus of minimum essential daily volume of storage (v_d) for each electrical power required and for each types of wasted biomass investigated.

Results are showed in Tab.9.

$$(10) \quad v_d = (\rho_i / \dot{M}_i)^{-1} \cdot \eta_{fi} \cdot 24$$

Power [kW_E]	Biomass	$\dot{M}_i [kg/h]$	$\eta_{fi} [m^3/m^3]$	$v_d [m^3/day]$
250	Olive pits	635	0.70	9.7
	Wood shavings	897	0.45	44.03
	Woody scraps	795	0.55	24.40
	Shells	683	0.60	16.39
	Marc	664	0.65	9.77
500	Olive pits	1,191	0.70	18.19
	Wood shavings	1,681	0.45	85.52
	Woody scraps	1,490	0.55	45.74
	Shells	1,281	0.60	30.74
	Marc	1,245	0.65	18.32
635	Olive pits	1,382	0.70	21.11
	Wood shavings	1,951	0.45	95.78
	Woody scraps	1,730	0.55	53.11
	Shells	1,487	0.60	35.69
	Marc	1,445	0.65	21.27

Tab.9

Fig. 6 shows the trend of daily volume for each biomass in function of required electrical power

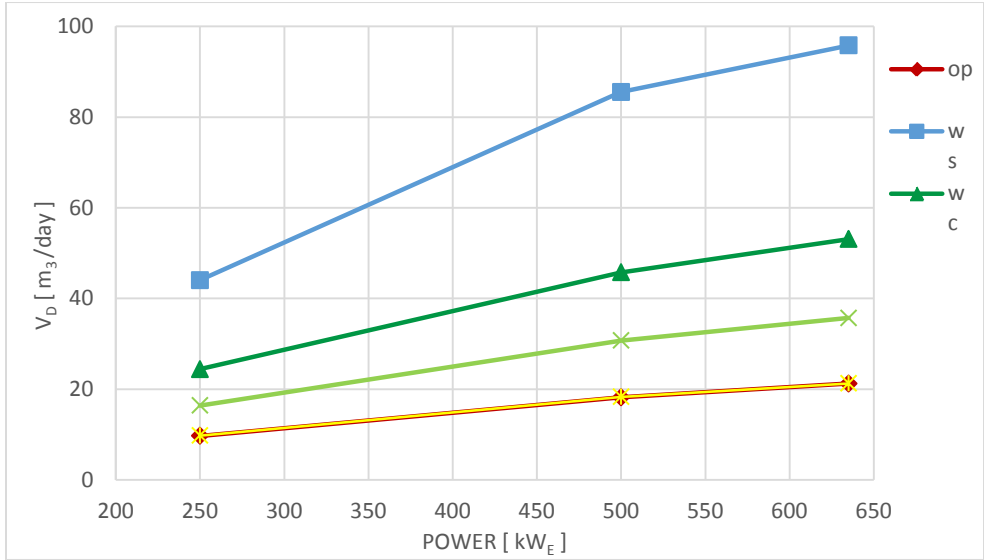

Fig.6

The pattern of Fig.6 allows a rough valuation of v_d also for powers not strictly corresponding to that ones investigated.

Removal of moisture from biomass

The removal takes place by almost convective heat exchange between hot air coming from CHP section and biomass.

Heat power of hot air must provokes the evaporation of moisture contained in biomass.

Formula (11) gives thermal power exchanged by air :

$$(11) \quad \dot{Q}_{Tar} = c_p \cdot \dot{M}_{ar} \cdot \Delta T$$

where:

- ΔT is the difference of temperature between hot air and biomass. From a practical point of view values of ΔT can range between 20°C (minimum value - ΔT_{min}) and 60°C (maximum value - ΔT_{max})
- In the range of thermal exchange the specific heat at constant pressure of air is $c_p = 0.24 \text{ kcal/kg } ^\circ\text{C}$ pretty well constant.
- \dot{M}_{ar} is the flow-rate of hot air.

The percentage of moisture contained in investigated biomass range between 20% and 60% so that people obtain the minimum of mass of moisture (\dot{M}_{H2Omin}) and the maximum (\dot{M}_{H2Omax}) through

$$\dot{M}_{H2Omin} = 0.20 \cdot \dot{M}_{imin} \quad \text{and} \\ \dot{M}_{H2Omax} = 0.60 \cdot \dot{M}_{imax} .$$

Using the relative numerical values of mass-flow of Tab.7, people obtain tab.10.

$P_{Ei} [kW_E]$	$\dot{M}_{H_2Omin} [kg_{H_2O}/h]$	$\dot{M}_{H_2Omax} [kg_{H_2O}/h]$
250	127	538
500	238.2	1,009
635	276.40	1,171

Tab.10

Formula (12) shows thermal power need to cause evaporation of moisture:

$$(12) \quad \dot{Q}_{ev} = r \cdot \dot{M}_{H_2O}$$

Where r is the latent heat of evaporation.

In range of temperature of thermal power exchange ($20^\circ\text{C} \div 60^\circ\text{C}$), the value of latent heat of evaporation can be pretty well constant as the average value $r = 575 \text{ kcal/kg}$

The almost convective heat of exchange must be such that \dot{Q}_{Tar} can supply \dot{Q}_{ev} and trough the formulas (11) and (12) is possible to write formula (13) :

$$(13) \quad \dot{M}_{ar} = (r / c_p \Delta T) \cdot \dot{M}_{H_2O} \cdot (1/\eta_{st})$$

Where η_{st} = efficiency of thermal exchanger.

Efficiency of thermal exchanger nowadays can reach up the value of 0.85 adopted.

Placing in (13) the values of Tab.10 people find the hot air flow-rate to removal moisture as showed in Tab.11.

$P_{Ei} [kW_E]$	$\dot{M}_{armin} [kg_{ar}/h]$	$\dot{M}_{armax} [kg_{ar}/h]$
250	19,907	25,286
500	33,586	47,423
635	38,972	55,037

Tab.11

First conclusion

All previous referred permits to LME to have guide lines for :

- Calculus of stockpile daily volume of storage v_d .
Of course each LME can calculate the volume of storage necessary for stockpile in function of times of operational cycle of its manufacturing and relative biomass wasted.
- LME can calculate hot air flow-rate to draw out moisture by data of stockpile in function of heat exchanging temperatures of air included between 20°C and 60°C .

References:

Rizzato, D., "Gassificazione della biomassa: analisi costruttiva di un gassificatore da 45 kW" Technical Report, 2012/2013.

Miscellanea from : Bridgewater, J (2012), Mohammad, I. J (2012), Somerville, C (2005), Grønli, M.G. (2002), Horn and Williams (1996). International Energy Agency, Annual Report, 2006, Pyrolysis of Biomass, Paris, France, IEA Bioenergy, 2006, Task 34.

Tippaya wong, N et al., “Yields and gaseous composition from slow pyrolysis of refuse-derived fuels”. Energy Source. Part A 2008, 30, 1572-1578.

Saidur, R, et al., “Effect of partial substitution of diesel by natural gas on diesel engine”. Proceedings of the Institution of Mechanical Engineers. Power Energy Part A, 2007, 221, 1-10.

Officine di Cartigliano spa, Cartigliano (VI), 2014.

Symbolism:

LME	:	Little and Middle Enterprises
CHP	:	Combined Heating and Power
R_M	:	Moisture
LHP	:	Lower heating power
LHP_0	:	Low heating power of dry substance
u	:	Moisture content on wet basis
u_0	:	Moisture content on dry basis
r	:	Heat of vaporization of water
m	:	Mass
\dot{m}_{op}	:	Average flow-mass of olive pits
\dot{m}_{sy}	:	Average flow-rate of produced syngas
C_s	:	Specific value consumption
TR	:	Thermal Rate
w (subscript)	:	Water
d (subscript)	:	Dry substance
sy (subscript)	:	Syngas
op (subscript)	:	Olive pits
ws (subscript)	:	Wood shavings
wc (subscript)	:	Woody scraps
sh (subscript)	:	Shells
ma (subscript)	:	Marc
i (subscript)	:	Generic
E (subscript)	:	Electrical
T (subscript)	:	Thermal
air (subscript)	:	Air
H_2O (subscript)	:	Water
P	:	Power
\dot{M}	:	Mass rate
η_t	:	Turbine efficiency
η_{ec}	:	Efficiency of energy conversion
η_{st}	:	Efficiency of thermal exchanger
η_f	:	Shape efficiency
v_d	:	Volume of storage
\dot{Q}_{Tar}	:	Thermal power
\dot{Q}_{ev}	:	Thermal power required for the evaporation of moisture

MODELED HYDROLOGIC RESPONSE UNDER CLIMATE CHANGE IMPACTS OVER THE BANKHEAD NATIONAL FOREST IN NORTHERN ALABAMA

Anil Acharya, Assistant Professor, PhD
Department of Mechanical and Civil Engineering,
Alabama A and M University

Abstract

The impacts of climate change on water availability over the Bankhead National Forest (BNF) and Sipsey Fork Watershed (SFW) located in northern Alabama is evaluated by developing a site specific hydrologic model inside the Soil and Water Assessment Tool (SWAT). The SWAT model is utilized over Sipsey Fork (SF) subbasin of SFW to assess hydrological response under changing climatic conditions until 2100. Calibration and validation of the SWAT model is performed at daily time steps by comparing simulated and observed streamflow. Altogether 13 parameters that directly influence surface/base flow and basin response were selected and calibrated; the model simulated streamflow very well as evidenced by correlation and error statistics (“ $r = 0.87$ “, “ $R^2 = 0.75$ “, and lower “RMSE = 12 cms“). Climate forcing (e.g. precipitation, temperature) from selected regional/global climate models that represent regional climatology well over the basin were incorporated into the SWAT model to determine future water availability in the basin. The projected average change in total annual streamflow for SF varies from -10% to -18%, which ranges -7% to -16% for A1B, and -12% to -23% for A2 until 2100. This study is conducted in conjunction with other ongoing studies that looked at the impacts of forest management on BNF hydrology. Major research findings from this study will help decision makers in evaluating the combined impacts of climate change and forest management on water availability, and developing strategies to sustain available natural resources.

Keywords: Climate Change, SWAT, Streamflow, Hydrologic Modeling

Introduction

Climate change is a major concern throughout the world. The major impacts of climate change have been documented on both quantity and quality aspects in different parts of the world (e.g., Bates et al. 1994; Aizen et al. 1997; Loukas et al. 2002; Jian and Shuo 2006). The likely impacts of climate change are observed on important sectors namely water, food/agriculture, ecology, energy, and other natural and environmental sciences. This further affects the planning, strategies, policies, and decision making of resource management in each sector. The output from various global and regional climate models (GCMs/RCMs) have been utilized to evaluate the regional or local impacts of climate change on water availability. Model simulations applying a number of GCMs, RCMs, multiple scenarios and projections have shown increasing or decreasing climate pattern based on various regions and seasons. Because various GCMs simulate future climate with different emission scenarios at different level of accuracy, utilization of multiple GCMs/RCMs and scenarios could be helpful to address uncertainty in climate-change-related studies (e.g., Covey et al. 2003; Beniston et al. 2007; Maurer 2007; Vicuna et al. 2007; Fowler and Ekström 2009). The methodology, model, and data sources adopted in this study are documented by various similar climate-change-related studies in the past (e.g., Christensen and Lettenmaier 2007; Miller et al. 2010).

This paper quantitatively assesses the potential effects of climate change on hydrology and water resources of the Bankhead National Forest (BNF). BNF is a region in northern Alabama where projected climate change and land use management could impact the available water resources. The William B. BNF is considered as one of four national forests in Alabama and is a part of the Southern Cumberland Plateau. The BNF covers 182,000 acres in northwest Alabama, and located in the counties of Franklin, Lawrence, and Winston. Almost 176,000 acres out of 182,000 acres of BNF is forested, which predominantly consists of unfragmented deciduous forest (mixed forest stands of hardwood and pine). This forest helps in protecting water quality, and also serves as a visiting arena for local and regional visitors. BNF is popular among people due to its wildlife, hunting, and recreational resources, as it consists of 26000 acre Sipsey Wilderness, 96000 acre Black Warrior Wildlife Management Area, and the Sipsey Wild and Scenic Rivers (Addor and Birkhoff, 2003). The BNF is occupied by both private and public ownership and has been impacted by this ownership pattern in addition to other ongoing land management practices, land use changes and burning and thinning of the forests. The impacts of Southern pine Beetles have also been observed in the past causing thousands of acres of pine forest convert to standing dead trees. Under changing future climatic conditions and ongoing

land management practices, it is expected to change the forest hydrology and water availability over the watershed, and impact various important sectors as discussed above. No detailed studies have been carried out in the past within the BNF that evaluate the combined impacts of climate change and forest management on forest hydrology and water availability over the BNF that is of so much value to the community.

Separate studies are ongoing to evaluate the effects of operational land management practices on water quantity and quality over several riparian areas within the BNF. While relating to streamflow forecasting under anthropogenic climate change conditions, this study can be utilized in future water availability assessment over the BNF. The results obtained from this study may assist water managers, decision makers, and stakeholders in understanding the alteration to forest hydrologic response under climate change, and planning and managing water resources allocation while meeting the requirements of diverse water demands. This study represents a comprehensive study of the SFW and develops streamflow projections under changing future climate conditions over the SFW by adopting a multimodel ensemble technique. Future water resources and land management alternatives could be suggested by decision makers as a proactive step in meeting the challenges of future water demands while evaluating the climate change impacts and operational land management practices within the BNF.

Methodology

Study Area

This study is carried out in the Sipsey Fork Watershed (SFW) located in northern Alabama. SFW also encloses the BNF (as indicated by green boundary in Fig 1). The SFW consists of several water quality measurement stations downstream near to the Lewis Smith Lake Reservoir that is popular amongst visitors for recreational activities. However, it possess only two streamgauge stations located upstream (see Figure 1) and at the outlet of Sipsey Fork (SF) and Clear Creek (CC) subwatersheds. Regions A and B in Figure 1 represent SF and CC subwatersheds of the SFW. The SF passes through the BNF, and CC flows outside the BNF, while both drains into the Smith Lake located far downstream.

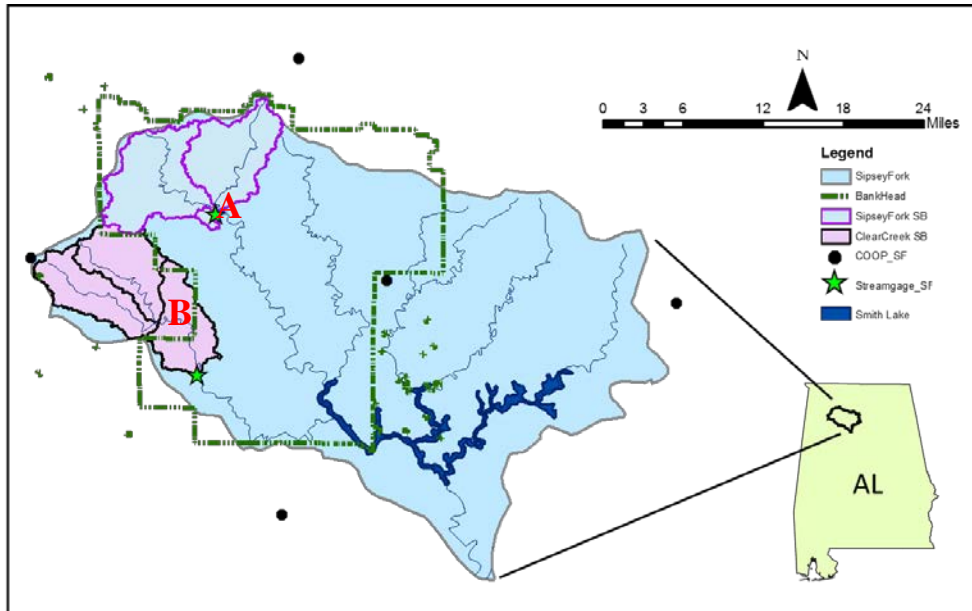

Figure 1: Location of the SFW and BNF in northern Alabama. The location of subbasins SF and CC, streamgauge stations (filled star), COOP stations (filled dots), and Smith Lake are also shown.

Hydrological Model

The Soil and Water Assessment Model (SWAT) is utilized to develop a site specific hydrologic model and evaluate the impacts of climate change on water availability over the SFW and BNF. ArcSWAT (V2012.10.14) is an ArcGIS-ArcView extension and graphical user input interface for SWAT (<http://swat.tamu.edu/software/arcswat/>). SWAT, a physically based and distributed parameter watershed scale model, has been widely used in the past for evaluating impacts of changing climate, land use/ land cover change, and agriculture management practices on both water quantity and quality (e.g. Lin et al., 2009; Santhi et al., 2006; Van Liew et al., 2007). The SWAT model inputs are readily available and the model runs on both daily and monthly time steps. The major inputs for SWAT model are watershed boundary, climate/weather, elevation, and soil parameters. The major outputs generated by the model are runoff/flows, ET sediments, nutrients, and heavy metals.

The calibration of the SWAT model can be performed manually or automatically. SWAT-CUP (SWAT Calibration and Uncertainty Procedures) has been utilized for automatic calibration of SWAT model. SWAT-CUP is a computer program freely available from the public domain. It includes different internal procedures (e.g. GLUE, ParaSol, SUFI2, MCMC, and PSO) to link to SWAT model and perform sensitivity analysis, calibration, validation, and uncertainty analysis

(<http://www.eawag.ch/forschung/siam/software/swat/index> Major calibration parameters for the model represent parameters that directly affect basin response (.bsn, .mgt), surface flow (.hru), base flow/ground water flow (.gw), and channel routing (.rte). A detailed description on the parameters that have been commonly utilized for calibration can be found in several references (e.g. Arnold et al., 2012; Neitsch et al., 2002; Shrestha, 2010; Van Liew et al., 2007; White and Chaubey, 2005). A number of parameters are considered during model calibration and the calibration is performed on daily or monthly time scale such that modeled streamflow resembles the historical streamflow. Various statistical parameters such as Pearson Correlation Coefficient (r), Root Mean Square Error (RMSE), and Coefficient of Determination (R^2) are calculated to examine the effectiveness of the calibrated parameters/model.

Data Description

The observed daily climate data (precipitation, max and min temperature) are obtained from the National Weather Service (NWS) Cooperative Observer Program (COOP) stations. Altogether five COOP stations are located in and near the SFW boundary (Fig 1). The wind speed and US STATSGO soil data is directly downloaded from the SWAT model. Other weather data is obtained from WGEN_US_First Order Stations. The land use land cover data is obtained from National Land Cover Data (NLCD, 2006, 2011; retrieved from <http://nationalmap.gov/viewer.html>). The 10m resolution digital elevation data is downloaded from the “National Map Viewer and Download Platform” (<http://nationalmap.gov/viewer.html>). The daily runoff data for the streamflow gages “02450250” and “02450825” located at the outlet of SF (near Grayson) and CC (new hope Church near Poplar Springs) subwatersheds are obtained from United States Geological Survey (www.usgs.gov).

A total of six future climate projections from two emission scenarios A1B and A2, and three GCMS namely CSIRO, CGCM, MIROC are adopted for this study based on a recent project “The Southern Forest Future Project” conducted in the SouthEast by USDA Forest Service. This project was conducted to “examine a variety of possible futures that could shape forests and the many ecosystem services and values forests provide” in the forests of 13 states of Southeastern United States (Wear and Greis, 2013). The county level climate projection data available from the project at monthly time steps from 2001-2100 are utilized for this study (Coulson et al. 2010). During the future forest assessment study, the county level climate data were developed based on Parameter-elevation Regressions on Independent Slopes Model (PRISM) climatology, and World Climate Research Programs (WCRP’s)

Climate Model Intercomparison Project Phase 3 (CMIP3) climate projections for the United States (Maurer et al, 2007; <http://gdo-dcp.ucllnl.org>).

Model Simulations

A trend/time series analysis is performed on GCM output, namely precipitation and temperature, for historical (2001-2010) and future time periods (2021-2099). The daily climate data from the COOP stations are translated into future climate by applying monthly change factors calculated based on GCM's output for current and future climatic conditions. The average change factor for each month for a total of 10 years period is calculated and applied to historical climate data to perturb it to future climate conditions. Readers can refer to various past studies to further explore the weighted average method and its application (e.g. Acharya et. al., 2013; Wood et al. 2004). The projected climate change scenarios for the SFW is forced into the calibrated SWAT model to derive multiple long term streamflow projections and evaluate future changes in water availability. All projections are treated equally likely such that the results follow ensemble representation. This analysis is focused on monthly, seasonal or annual changes in streamflow. Significant changes in climate parameters, flood peak magnitude, and total runoff volume are calculated during each 10 years period until 2099. The impacts of climate change on streamflow is compared for different climate scenarios, based on simulated daily, monthly, seasonal or annual streamflow for present and future periods. The major results presented in this paper are limited to the SF, while the study for the CC subbasin will be presented in a separate paper.

Results

Climate Pattern

The climate data for the Winston County in northern Alabama is assessed since most of the study area (including BNF) is located in the Winston County. As mentioned earlier, a total of 6 projections from 3 GCMs (CSIRO, CGCM, MIROC) and 2 emission scenarios (A1B, A2) are analyzed and compared with baseline time period (2001-2010). While comparing monthly change in average temperature from all projections, a simultaneous increase in mean temperature is observed for all months from 2021 to 2100, with a maximum rise up to 6°C during summer months at the end of the century (Figure 2a). However, the minimum rise in average temperature varies from 0.2°C to 2°C for A1B, and -0.2°C to 3°C for A2; the maximum rise varies from 1.6°C to 5°C for A1B, and 2.2°C to 6.6°C for A2; the average rise varies from 1°C to 3.5°C for A1B, and 1.2°C to 5°C for A2 respectively (Figure 2b).

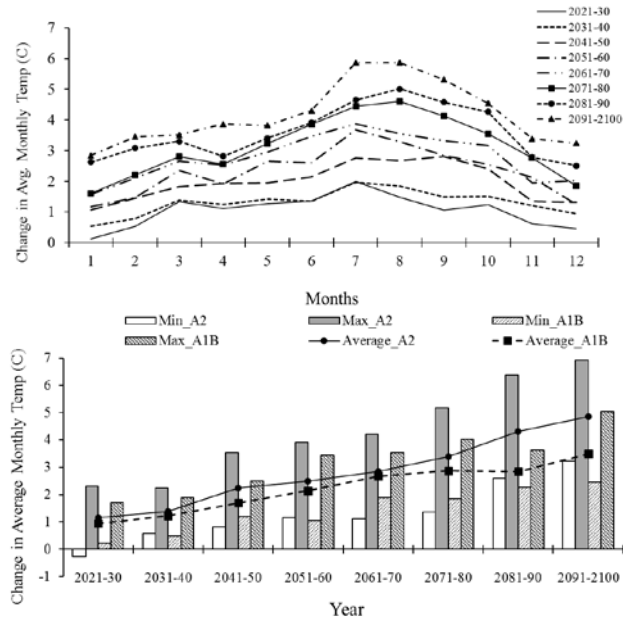

Figure 2: Change in average monthly temperature from 2021-2100 with respect to 2001-2010 for all projections. a) mean monthly change for Jan-Dec; b) minimum, maximum and average change for each scenario.

Figure 3a and 3b shows the change in average monthly precipitation for future periods with respect to 2001-2010 for all projections and for each scenario respectively. Precipitation shows both increasing and decreasing pattern for the months of Feb, Oct, Nov, and Dec. All other months show a decreasing pattern where the range varies from -1% to -30% for differing time periods and months. The range of minimum and maximum change in average monthly precipitation during 2021-2100 is higher for A2 as compared to A1. The minimum change in average precipitation varies from -15% to -30% for A1B, and -25% to -40% for A2; the maximum change varies from 6% to 25% for A1B, and 7% to 35% for A2; the average change varies from -1% to -5% for A1B, and -5% to -10% for A2 respectively. For both scenarios, the average change in mean monthly precipitation shows decreasing pattern (-ve) which signals towards decrease in total water availability for the study area in future periods.

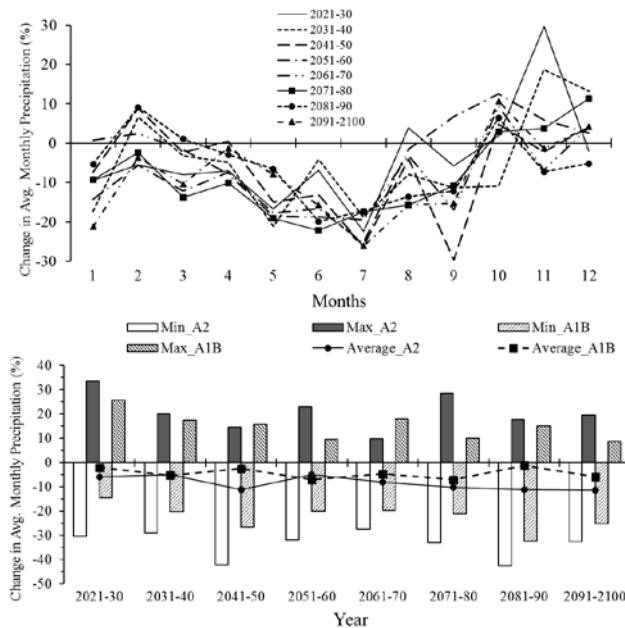

Figure 3: Change in average monthly precipitation from 2021-2100 with respect to 2001-2010 for all projections. a) mean monthly change for Jan-Dec; b) minimum, maximum and average change for each scenario.

Model Calibration and Validation

The ArcSWAT model is calibrated and validated for the SF based on daily time steps from 1980-1995, and 1996-2012 respectively. Altogether 13 model parameters are chosen for calibration purpose. The parameters used for model calibration and the calculated statistics during calibration and validation are presented in **Table 1**. During calibration and validation periods, the simulated daily streamflow represents observed daily streamflow quite well for base flows as well as most peak flows except some over/under estimation of higher peaks (**Figure 4**). This results in a very good calibration with higher ' $r=0.87$ ' and ' $R^2=0.75$ ' and lower ' $RMSE=12$ '. A slightly lower ' $r=0.79$ ' and ' $R^2=0.64$ ' during validation period is due to underestimation of some higher peaks. Among all 13 parameters used during calibration, CN2 is found as the most sensitive parameter.

Streamflow

Monthly Streamflow

Figure 5 shows the change in mean monthly streamflow with respect to baseline period for each decade starting from 2020's. Both A1B and A2 scenarios show a decrease in mean monthly streamflow for future periods, except during Oct, Nov and Dec which shows both increasing and decreasing pattern at different time periods.

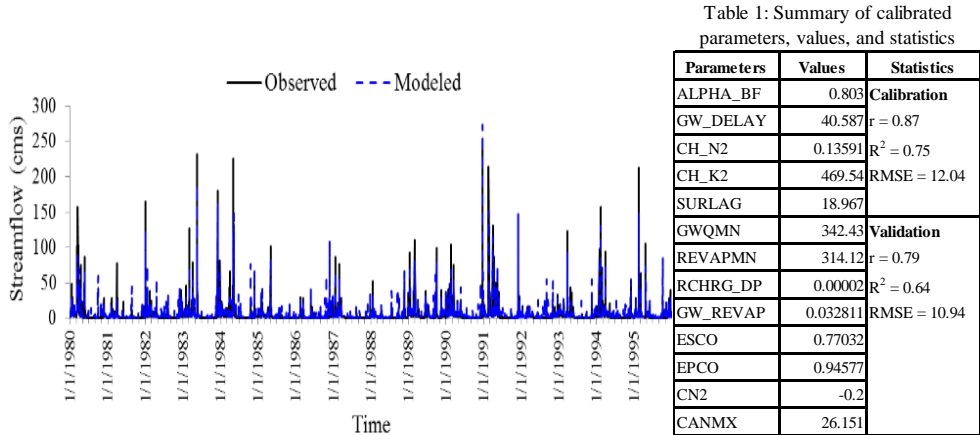

Table 1: Summary of calibrated parameters, values, and statistics

Parameters	Values	Statistics
ALPHA_BF	0.803	Calibration r = 0.87 R ² = 0.75 RMSE = 12.04
GW_DELAY	40.587	
CH_N2	0.13591	
CH_K2	469.54	
SURLAG	18.967	Validation r = 0.79 R ² = 0.64 RMSE = 10.94
GWQMN	342.43	
REVAPMN	314.12	
RCHRG_DP	0.00002	
GW_REVAP	0.032811	
ESCO	0.77032	
EPCO	0.94577	
CN2	-0.2	
CANMX	26.151	

Figure 4: Observed and simulated daily streamflow (m³/s) during calibration period (1980-1995)

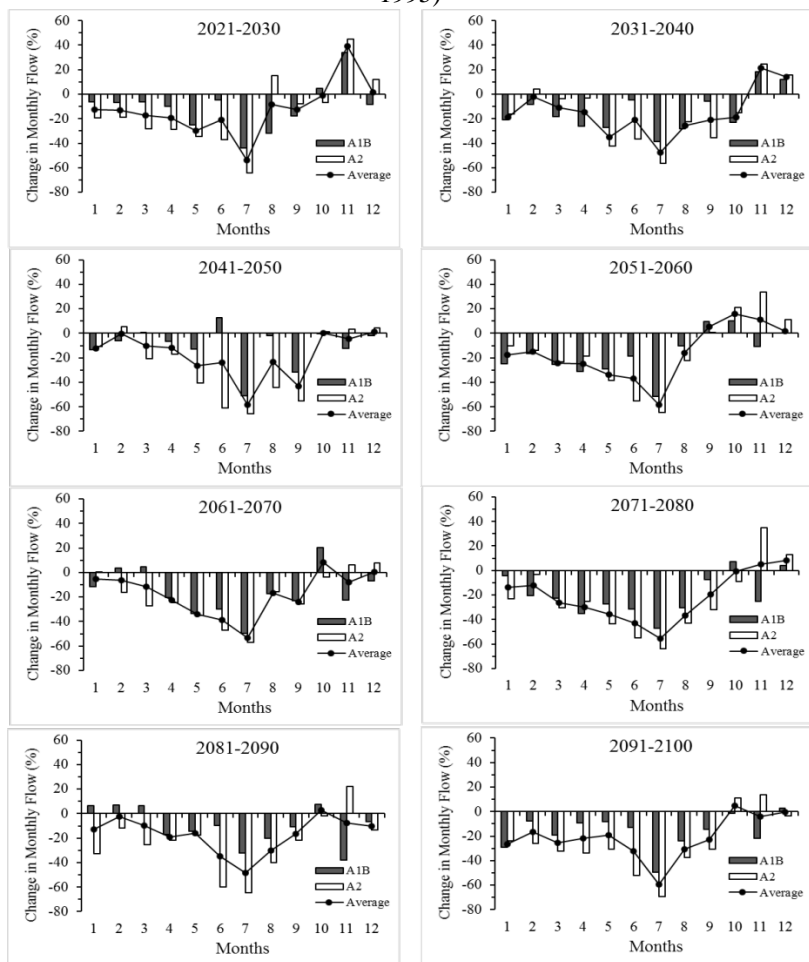

Figure 5: Change in simulated monthly streamflow (in percent) during 2021-2100 (each 10 years interval) with respect to baseline period (2001-2010) for emission scenarios A1B and A2.

An average decrease of almost 50% is calculated for some months while the maximum decrease in mean monthly streamflow is observed for A2 scenario during the months of June and July.

While comparing simulated minimum change in mean monthly streamflow as shown in **Figure 6**, a maximum decrease of -40% to -90% is calculated for the MIROC model, which is in the range of -25% to -60% for other models. While comparing simulated maximum change in mean monthly streamflow, an increase of 10% to 120% is calculated for CSIRO and CGCM; the simulated changes for MIROC varies from -30% to +30% (except 2021-30 for A2) for the same scenario. Comparatively, MIROC model simulated almost double decrease in monthly streamflow as compared to other models.

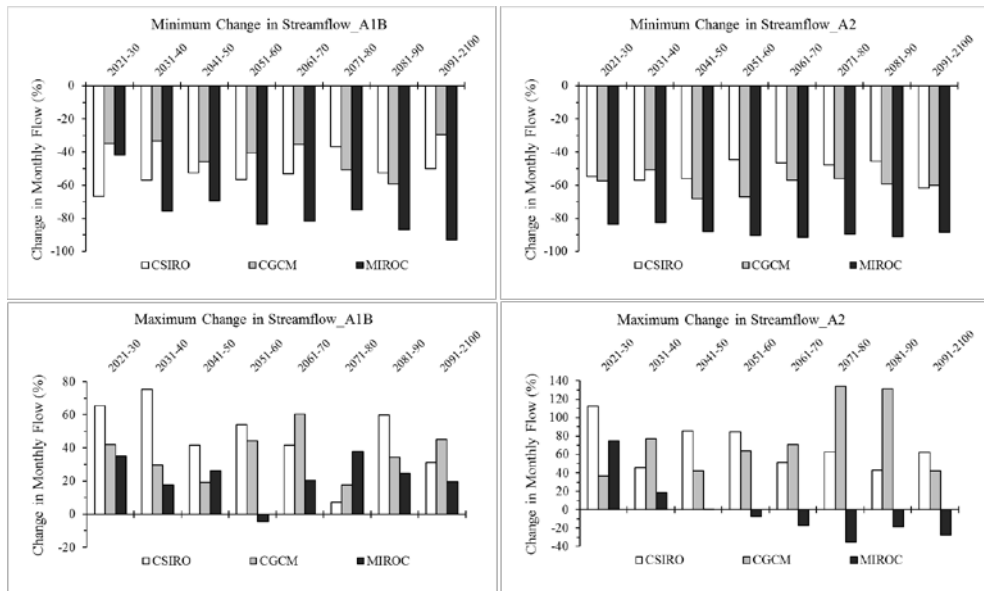

Figure 6: Comparison of simulated minimum and maximum changes in mean monthly streamflow during 2021-2100 with respect to 2001-2010 for emission scenarios A1B and A2, and GCMs CSIRO, CGCM, and MIROC.

Annual Streamflow

Figure 7 shows the simulated total annual streamflow for each GCMs and emission scenarios. The total annual streamflow shows both increasing and decreasing pattern for future time periods. The three black dotted lines show the 90th percentile, mean, and 10th percentile annual streamflow for the baseline period. During some years in the middle century, CSIRO and CGCM shows annual streamflow higher than 90th percentile flow values. For the same models, few years show annual streamflow less than 10th percentile, while during other years simulated annual streamflow lies above and below the average annual flow. A comparatively very low annual streamflow is simulated by the MIROC where the annual streamflow

is less than 10th percentile for most years (except some years). The simulated annual streamflow is higher for A2 before, during and after half century, while it is higher for A1B at the end of the century (2081-2100). A very low annual streamflow is simulated by MIROC as compared to CGCM and CSIRO. While combining all projections for each scenario as shown in Figure 8a, average change in annual streamflow varies from -10% to -18%, which ranges -7% to -16% for A1B, and -12% to -23% for A2. While combining projections from CSIRO and CGCM only (Figure 8b), average change in annual streamflow varies from -3% to -9%, which ranges -3% to -11% for A1B, and 0.5% to -10% for A2. This signals towards the occurrence of drought years in future, however, the simulated streamflow clearly shows higher reduction (more than half) due to MIROC projections alone.

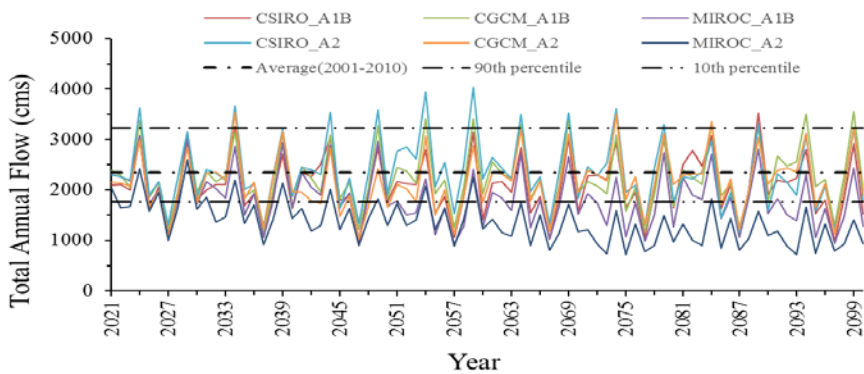

Figure 7: Simulated total annual streamflow (m³/s) during 2021-2100 for emission scenarios A1B and A2, and GCMs CSIRO, CGCM, and MIROC.

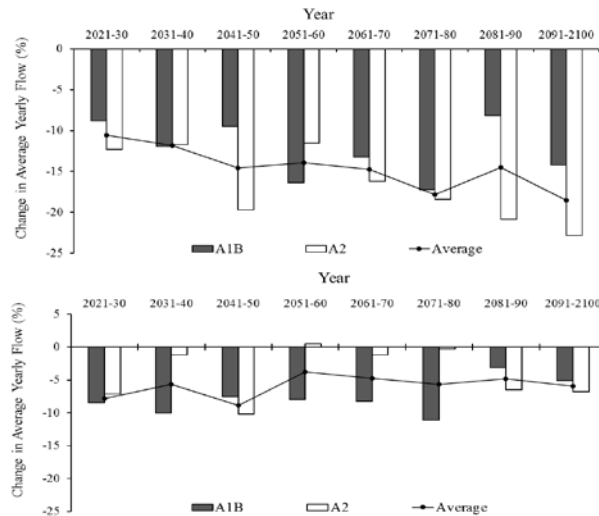

Figure 8: Comparison of simulated changes in average total annual streamflow (in percent) during 2021-2100 (each 10 years interval) with respect to 2001-2010 for emission scenarios A1B and A2: a) based on all GCMs CSIRO, CGCM, and MIROC; b) based on GCMs CSIRO and CGCM only.

Discussion

The modeled results obtained from this study clearly shows a decrease in future water availability over the sub-basins based on projected emission scenarios over the region. A higher decrease in simulated monthly and total annual streamflow for future periods is due to combined impacts of decreased precipitation and increased temperature. This study provides an indication of lower water availability in future climate which may further aggravate the water stress condition if there exists an increasing water demand over the region. This study also provides an outlook of hydrologic changes based on future climate scenarios; however the various uncertainties (e.g. station data, GCMs output, downscaling method, hydrological models) associated with this type of climate change related studies should be clearly understood before applying the results and making decisions on future management measures. All GCMs are developed for a specific purpose and with different assumptions and limitations, therefore, the practical application and simulated results for each GCM is different. As discussed earlier, this study considers only three climate models and two emission scenarios. While comparing precipitation and simulated streamflow, MIROC model is possibly under-predicting as compared to CGCM and CSIRO. Utilization of multi-model and focus on mean climate is assumed to provide a more reliable estimate of the future uncertainty. Further research with inclusion of more GCMs, scenarios, and climate projections available from WCRP CMIP3 database could be performed to look at the range of maximum/minimum change in water availability for this region. The climate data utilized in this study are at the county level. Parts of the SFW is located in the Winston and Lawrence county with similar climate pattern (not shown here separately) for both counties, the simulated result is not expected to vary. However, application of gridded finer resolution climate data and utilization of a more distributed hydrologic model might simulate significantly better results. The downscaling method used in this analysis only considers the change in rainfall intensity for a future climate, with land use, variability of extreme events and other watershed characteristics remaining constant. However, the use of other downscaling techniques may alter the simulated results more than the results from the existing approach.

Conclusion

This study has incorporated downscaled climate data into a distributed hydrological model to evaluate watershed level impacts of climate change on water quantity over the SFW. As mentioned earlier, concurrent studies are undergoing that evaluate impacts of climate change and forest management on water quantity over the CC, SF, and SFW. Utilizing results obtained from this study, one could assess the potential

impacts of climate change on water resources, and design additional management measures to meet diverse future water demand more effectively while looking at the combined impacts of climate change and ongoing forest management measures over the SFW and BNF. However, various uncertainties associated with this type of climate change and hydroclimatic modeling studies should not be neglected while planning and designing additional water management measures.

Acknowledgements

This research is supported by the NSF-CREST Award ID: 1036600. The author would like to acknowledge Dr. Wubishet Tadessee and Dr. Dawn Lemke for providing support and assistance to conduct this research through the department of biological and environmental sciences at Alabama A&M University.

References:

- Acharya, A., K. Lamb, and T.C. Piechota, 2013. Impacts of climate change on extreme precipitation events over Flamingo Tropicana watershed. *JAWRA*, 49(2): 359-370.
- Addor, M.L., and Birkhoff, J. (2003). Bankhead National Forest Health and Restoration Initiative: Final Report. Prepared for the USDA Forest Service, National Forests in Alabama, Bankhead National Forest.
- Aizen, V.B., Aizen, E.M., Melack, J.M., and Dozier, J. (1997). "Climatic and hydrologic changes in the Tien Shan, Central Asia." *Journal of Climate*, 10, 1393-1404.
- Arnold, J. G., D. N. Moriasi, P. W. Gassman, K. C. Abbaspour, M. J. White, R. Srinivasan, C. Santhi, R. D. Harmel, A. van Griensven, M. W. Van Liew, N. Kannan, and M. K. Jha. 2012. SWAT: Model use, calibration, and validation. *Transactions of the ASABE*, 55(4):1491-1508.
- Bates, B.C., Charles, S.P., Sumner, N.R., and Fleming, P.M. (1994). "Climate change and its hydrological implications for South Australia." *T. Royal Soc. of South. Australia*, 118(1), 35-43.
- Beniston, M., Stephenson, D.B., Christensen, O.B., Ferro, C.A.T., Frei, C., Halsnaes, K... Woth, K. (2007). "Future extreme events in European climate: An exploration of regional climate model projections." *Climate Change*, 81(1), 81– 95.
- Christenten, N.S., Wood, A.W., Voisin, N., Lettenmaier, D.P., and Palmer, R.N. (2004). "The effects of climate change on the hydrology and water resources of the Colorado River Basin." *Climate Change*, 62, 337-363.
- Coulson, David P.; Joyce, Linda A.; Price, David T.; McKenney, Daniel W.; Siltanen, R. Martin; Papadopol, Pia; Lawrence, Kevin. 2010. Climate Scenarios for the conterminous United States at the county spatial scale

- using SRES scenarios A1B and A2 and PRISM climatology. Fort Collins, CO: U.S. Department of Agriculture, Forest Service, Rocky Mountain Research Station. <http://dx.doi.org/10.2737/RDS-2010-0008>, <http://www.fs.fed.us/research/rpa/assessment/climate-data.php>
- Covey, C., AchutaRao, K.M., Cubasch, U., Jones, P., Lambert, S.J., Mann, M.E., Phillips, T.J., and Taylor, K.E. (2003). "An overview of results from the coupled model intercomparison project." *Global Planet Change*, 37, 103–133.
- Fowler, H. J., and Ekström, M. (2009). "Multi-model ensemble estimates of climate change impacts on UK seasonal precipitation extremes." *Int. J. Climatology*, 29, 385– 416.
- Jian, W., and Shuo, L. (2006). "Effect of climate change on snowmelt runoffs in mountainous regions of inland rivers in Northwestern China." *Science in China*, 49(8), 881-888.
- Lin, Z., D. E. Radcliffe, L. M. Risse, J. J. Romeisd, and C. R. Jackson. 2009. Modeling Phosphorus in the Lake Allatoona Watershed Using SWAT: II. Effect of Land Use Change. *Journal of Environmental Quality*, 38(1):121-129.
- Loukas, A., Vasiliades, L., and Dalezios, N.R. (2002). "Potential climate change impacts on flood producing mechanisms in southern British Columbia, Canada using the CGCMA1 simulation results." *Journal of Hydrology*, 259, 163-188.
- Maurer, E. P. (2007). "Uncertainty in hydrologic impacts of climate change in the Sierra Nevada, California under two emissions scenarios." *Climatic Change*, 82, 309–325.
- Miller, W.P., Piechota, T.C., Gangopadhyay, S., and Pruitt, T. (2010). "Development of streamflow projections under changing climate conditions over Colorado River Basins headwaters." *Hydro and Earth Sys Sci Disn*, 15, 2145-2164, doi:10.5194/hess-15-2145-2011, 2011.
- Neitsch, S.L., J.G. Arnold, J.R. Kiniry, and J.R. Williams. 2002. Soil and Water Assessment Tool User's Manual, Version 2000.
- Santhi, C., R. Srinivasan, J.G. Arnold, and J.R. Williams. 2006. A modeling approach to evaluate the impacts of water quality management plans implemented in a watershed in Texas. *Environmental Modeling and Software*, doi:10.1016/j.envsoft.2005.05.013, 21:1141-1157.
- Shrestha, N.K., P.C. Shakti, and P. Gurung. 2010. Calibration and validation of SWAT model for low lying watersheds: A case study on the KlieneNete watershed, Belgium. *HYDRO NEPAL*, 6:47-51.
- Van Liew, M.W., T.L. Veith, D.D. Bosch, and J.G. Arnold. 2007. Suitability of SWAT for the conservation effects assessment project: Comparison on USDA agricultural research service watersheds. *Journal of Hydrologic Engineering*, 12(2):173-189.

Vicuna, S., Maurer, E.P., Joyce, B., Dracup, J.A., and Purkey, D. (2007). "The sensitivity of California water resources to climate change scenarios." *JAWRA*, 43(2), 482–498.

Wear, David N. and Greis, John G. 2013. The Southern Forest Futures Project: Technical Report. USDA Forest Service Research and Development Southern Research Station, General Technical Report SRS-178 (Accessed Online <http://www.srs.fs.usda.gov/pubs/44183> Full Report, Summary Report <http://www.srs.fs.usda.gov/pubs/42526>)

Wood, A. W., Leung, L.R., Sridhar, V., and Lettenmaier, D.P. (2004). "Hydrologic implications of dynamical and statistical approaches to downscaling climate model outputs." *Climatic Change*, 15, 189-216.

White, K.L., and I. Chaubey. 2005. Sensitivity analysis, calibration, and validation for a multisite and multivariable SWAT model, *JAWRA*, 41(5):1077-1089.

TECHNIQUES OF CCHP AS A RIGHT WAY TO APPLY THE 2ND LAW OF THERMODYNAMIC: CASE STUDY (PART ONE)

Prof. Eng. Francesco Patania

Prof. Eng. Antonio Gagliano

Prof. Eng. Francesco Nocera

Department of Industrial Engineering (DII) of Catania University (Italy)

Eng. Agrifoglio Antonio

Independent researcher

Abstract

Paper illustrates the design of an “Efficient Energy System” (EES) to supply energy to a new hospital of Catania (CH). It is shown the way to build EES through CCHP techniques and the analysis of energy request of EES during whole period of year. Paper shows also as EES, and connected CCHP techniques, achieves on the basis of 2nd Law of Thermodynamic significant economical decreasing of operational costs of CH and remarkable environmental benefits.

Keywords: Energy System, Design, CCHP, Hospital

Introduction

The area of pertinence of CH covers about 230,500 m² of which 28,500 m² with a built cubage of 405,000 m³ (Fig.1 and Fig.2). Environmental balance was evaluated comparing polluting air emissions expected from the EES with the pollution of an energy supplying trough traditional system. A reduction of impact on environmental component “atmosphere” was arose by the designed Thermodynamic Architecture and Plants. The EEC takes to a significant reduction of pollution influencing “atmosphere”.

The main data about HC are:

Plan features	:	applied research and constructive performance
Customer company	:	San Marco Hospital – Catania (Italy)
Planning	:	Thermodynamic Architecture and Plants planned by Authors
Funding	:	Regional Department of Health of Sicily (Italy)
Value of fulfillment	:	Cost of EES plants more than €18,000,000
Achieving purposes by	:	production of 5,25 MW _e (electrical power) and

EES : simultaneously production of 11,0 MW_t (heat energy) to feed HVAC plant and to supply energy for “hot sanitary water” and other utilities

Market : since the beginning of planning Designers considered a surplus of electricity production , in relation with requires of CH, to market to National Electrical Network for about ~ 150,000 €year

Currently status : forecasted end of work the next December 2015.



Fig. 1 – CH perspective Nord



Fig. 2 – CH Perspective Est

For room reason, since the extended size of subject, the treatise of topics will show in three part of which the first in present paper.

- part one: thermodynamic of EES and short description of loop of plants
- part two: quantification of environmental benefits
- part three: quantification of economic benefits.

Efficient Energy System (EES)

A gas turbine (Typhoon of Siemens) powered by methane and coupled with an alternator and one Heat Recovery Steam Generator (HRSG), supplies electric power of 5,25 Mw_e, more than amount needed by CH during operation. Following the basis of 2nd Law of Thermodynamics, thermal energy abundantly contained in exhaust gasses of turbine, continuously at intervals of temperature well-defined and with decreasing values of temperature for each interval, powers a sequence of CH operational functions. By appropriate heat exchanges with water, previously thermal energy is exploited to produce low-pressure steam to power cooling absorption cycle, to produce hot sanitary water, to produce hot water for various utilities, to feed HVAC plants and so on. Fig. 4 shows the final energy architecture of EES.

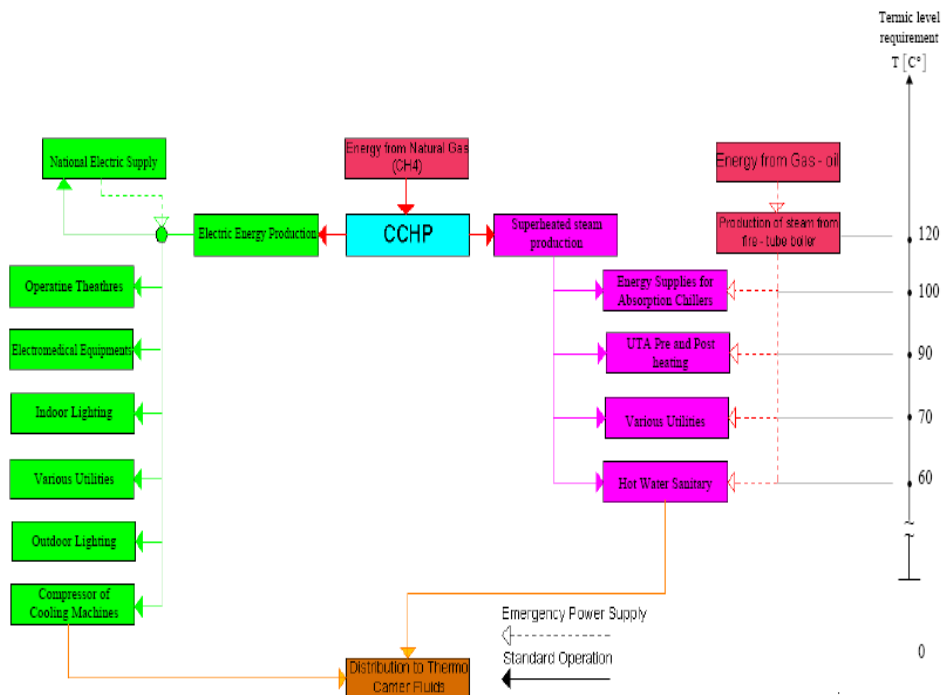

Fig. 4 – Architecture of EES.

Energy required of CH

Opting for a slight dependence from National Electrical Network, cogeneration group will operate 24 hours at full-load in June, July and August, at 70% of full-load in January, February, March, April, May, June, September and December and at 50% in October and November. Tab. 1 shows the equivalent hours of operation of cogenerator.

Based on previous operational times people forecast:

– Steam request for HVAC: about 23,75 tons/h in Summer time (that in Sicily is from May to August) and about 14,60 tons/h in Winter time (from November to February).

The request is less and variable in Spring time and Autumn time in function of real local conditions of weather climate.

– Tab.2 shows electrical power request for indoor and out-door lighting and for various utilities (Electro-medical equipments etc. etc.)

– Tab.3 shows thermal power request for hot sanitary water, HVAC etc. etc.

Months	Days	Operating time (h)	% of full-load operation ϵ	Equivalent time of full-load (h)	Total equivalent (h)
January	31	24	70	16,80	520,8
February	28	24	70	16,80	470,4
March	31	24	70	16,80	520,8
April	30	24	70	16,80	504,0
May	31	24	70	16,80	520,8
June	30	24	100	24,0	504,0
July	31	24	100	24,0	520,8
August	31	24	100	24,0	520,8
September	30	24	70	16,80	504,0
October	31	24	50	12,00	520,8
November	30	24	50	12,00	504,0
December	31	24	50	12,00	520,8
Total yearly	365	8.760			6,133.0

Tab. 1 – Equivalent hours of operation of cogeneration group

Unit of air treatment	815 Kw _e
Outdoor lighting	60 Kw _e
Indoor lighting	350 Kw _e
Electrical medical equipments	1,200 Kw _e
Centrifugal compressors (n. 14)	3,219 Kw _e
Medical operation rooms (n. 14)	560 Kw _e
Various utilities	936 Kw _e
Total amount	7.140 Kw_e

Tab. 2 - Forecast request of CH electrical power

Summer time	[Kw _t]	Winter time	[Kw _t]
Hot sanitary water	1,425	Hot sanitary water	1,425
Cooling batteries for U.T.A.	538	Post heating (HVAC)	5,650
Absorption cooling machines	12,887	Hot separated circuits	1,415
Various utilities	1,650	Various utilities	1,650
Total amount	16,500		10,140

Tab. 3 – - Forecast request of CH thermal power

Main machines and equipments

- CH cogeneration group (Typhoon – Siemens) including gas-turbine, electrical power unit and HRSG:

- Forecast units	:	n.1
- Output of electrical power	:	>5,100Kw _e
- Steam out-put	:	12,750 Kg/h at 10 bar
- operational parameters for best efficiency	:	> 96%
- height on sea level	:	50 ÷ 90 m
- temperature	:	15 °C
- atmosphere pressure	:	1,007 bar
- features of exhaust gas	:	T = 535 ÷ 550°C M' = 20,4 Kg/s
- combustive air flow rate	:	M' = 80 ÷ 82 Nm ³ /h

- Fire-tube boiler:

- units	n. 3
- nominal power: n° 3 x 2,780 Kw _t =	8,340 Kw _t
- steam production: n° 3 x 5000 Kg/h =	15,000 Kg/h

- Cooling machines at compression cycle:

- units	n. 2
- “cold” production: n° 2 x 4,079Kw _f =	8,158 Kw _f

- Cooling machines at absorption cycle:

- forecast units	n. 2
- “cold” production: n° 2 x 4,037 Kw _f =	8,174 Kw _f

Types of management

On the basis of energy requests, there are two types of management:

I - Full-load management, in absence of anomalies or unexpected occurrences during operations

- Peak of electrical request: 7,14 Mw_e of which 5,125 Mw_e by electrical power unit of cogeneration group and 2,02 Mw_e by local electrical network.

- Peak of thermo-refrigerating request: 16,50 Mw_f of which 2 x 4,15 Mw_f by absorption cycle machines and 2 x 4,15 Mw_f by compression cycle machines.

Management in case of unexpected emergencies.

There are two main emergencies:

- First occurrence: in case of blackout of local electrical network.
The smallest evaluated energy request of CH in emergency are:
 - electrical load: the 60% of full load, that is 4,28 Mw_e. Cogeneration group (5,125 Mw_e) supplies this amount
 - thermal load: the 50% of full load, that is 8,33 Mw_t. Cogeneration group supplies this amount too (8.88 Mw_t)
- Second occurrence: in case of blackout of cogeneration group.
The smallest evaluated energy request of CH in emergency are:
 - electrical load: the peak of 7,14 Mw_e fully supplied by local electrical network
 - thermal load: the peak of 8,33 Mw_t supplied by n. 3 fire-tube boilers.

Tab. 4 shows the synoptic frame of energy requests and relative supplies in various operating conditions.

Kind of operation	Electrical request [Mw _e]	Electrical supply [Mw _e]	Thermo-refrigerating request [Mw _t]	Thermo-refrigerating supply [Mw _t]
Full load operation	7.14	5.125	16.5	8.25
		2.02		8.25
Various intermediate loads operation	Automatic variation of loads controlled by computer programs			
First emergency op.	4.28	5.125	8.33	8.85
Second emergency op.	4.28	7.14	8.33	8.33

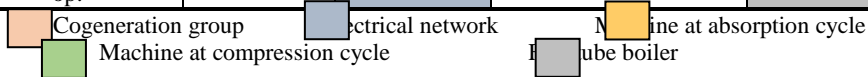

Kind of operation	Steam request [Kg/h]	Steam supply [Kg/h]
Full load operation	14,600	12,745
		3,000
	23,750	12,745
		12,000
First emergency op.	14,596	12,750
		3,000
	14,596	12,750
		3,000
Second emergency op.	14,596	15,000
	14,596	15,000

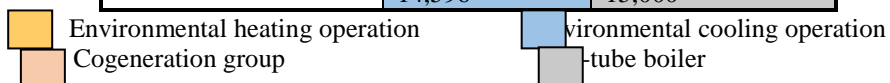

Tab. 4 – Synoptic frame of supplies.

Energy balances

Based on real data coming from others hospitals about similar to CH as regard medical functions and number of beds (~ n. 700), it is extrapolated “equivalent hours of operations” as previously shown in Tab. 1. By data of Tab. 1, Tab. 5 shows the forecast amount of electrical energy to market to national electrical network

Months	Forecast request [KWh _e]	Forecast production by cogenerator [KWh _e]	Forecast marketable energy [KWh _e]
January	1,560,000	2,513,232	953,232
February	1,495,000	2,270,016	775,016
March	1,430,000	1,621,536	191,536
April	1,300,000	2,432,160	1,132,160
May	1,430,000	2,513,232	1,083,232
June	2,340,000	2,432,160	92,160
July	2,860,000	3,589,800	729,800
August	2,470,000	3,589,800	1,119,800
September	1,950,000	2,432,160	482,160
October	1,495,000	1,795,272	300,272
November	1,430,000	1,795,272	365,272
December	1,495,000	1,795,272	300,272
Total yearly	21,255,000	28,779,912	7,524,912

Tab. 5 – Marketable electrical energy

Conclusion

- It is possible to get a high efficiency of loop of plants supplying energy for any kind of buildings or industrial processes if the thermodynamics design get a rational exploitation of energy based on Second Law of Thermodynamic.
- There is not general routine to design EES as there are many parameters at the basis of design: kind of activities carried out in construction, weather-climate of location, materials forecasted in architectural design, electrical and thermal power required etc., etc. All that previously parameters reported implies the needing to design an aimed EES for each kind of buildings.
- Thermodynamic design changes always for each changing of singular category of constructions.
- The right design of EES takes to economic benefits since decreases operational costs.
- EES takes to environmental benefits since decreases amount of polluting matters yearly leaded into atmosphere.

References:

Patania F., Manzo C., Gagliano A. & Nocera F., “*How to get Energy economics and environmental benefits, an applied research*”, III International Conference Economics and Management of Energy in Industry, April 2004, Lisbon, Portugal.

Patania F., Gagliano A. & Nocera F., “*Innovative Technology, Energy Saving and Respect for Environmental in HVAC System, of Typical Mediterranean City*”, CLIMAMED Conference, C.M. Joppolo AICARR Editions, pp. 1079-1088, Rome, 2007.

Official Endorsement / Executive Designers / Authorization to build, Decree of Sicily Department of Environmental and Region Planning n. 533 of 06/29/2005.

Symbolism:

CCHP:	Combined Cooling Heating and Power
EES:	Efficient Energy System
CH:	Hospital of Catania
HVAC:	Heating Ventilation and Air Conditioning
HRSG:	Heat Recovery Steam Generator
e (subscript):	electrical
t (subscript):	thermal
f (subscript):	refrigerating
UTA:	Air Treatment Unit
TOE:	Tons of Oil Equivalent

CLOUD COMPUTING AND ITS EFFECT ON PERFORMANCE EXCELLENCE AT HIGHER EDUCATION INSTITUTIONS IN EGYPT (AN ANALYTICAL STUDY)

Ahmed Hussein, Ass/Prof.

Omar Mohamed, Ass/Prof.

Faculty of Education, Assiut university, Egypt

Abstract

This period is marked by current financial crisis and challenges related to many growing needs. Consequently, universities are facing problems in providing necessary information technology (IT) support for fulfilling excellence in performance. More specifically, the best practices of Cloud Computing need to be considered within higher education institutions. Therefore, the current study aimed at investigating cloud computing, in terms of: (1) definition; (2) its most important principles; (3) models; and (4) benefits of its use to fulfill performance excellence in higher education institutions. This involves shedding light on cloud computing models and the possibility of its use in higher education institutions, and exploring the effect of using cloud computing in achieving performance excellence there. Additionally, the study aimed at clarifying the challenges and obstacles that face cloud computing. To reach these objectives, the researchers employed a qualitative research methodology for collecting and analyzing data. The study concluded some results, most important of which are: (1) there is a significant relationship between cloud computing and excellence of performance as cloud computing mainly aims at achieving tasks quickly with the least effort and cost. Personnel, customers, innovation and leadership are the core elements to achieve excellence in higher education institutions, and are major components of cloud computing. These positive results support the use of Cloud-Computing solutions in universities and improving knowledge in this field and providing a practical guide adaptable to the university structure.

Keywords: Cloud computing, excellence of performance, higher education.

Introduction

Research Problem

Higher education was acknowledged in time as one of the pillars of society development. Through the partnerships between universities, government and industry, researchers and students have proven their contribution to the transformation of society and the entire world economy (Lazowska et al., 2008). The tendency observed during the last few years within the higher education level (Mircea, 2010; Bozzelli, 2009), is the universities' transition to research universities and ongoing update of the IT (Information Technology) infrastructure as foundation for educational activities and academic research. With the evolution of technology, the number of services which migrate from traditional form to the online form grows as well. Accordingly, the universities must perform changes in order to be service oriented and in order to fulfill excellence in performance, and this will not be achieved unless higher education institutions do their best to apply modern trends in IT services, such as cloud computing.

Cloud Computing is an exciting technological breakthrough and a compelling discipline that has already exhibited profound implications on how we work, collaborate and share knowledge. Remarkably, this happens regardless of the geographical and temporal space in which knowledge seekers and knowledge providers physically exist. Srinivasan and Getov (2011) report that Cloud Computing represents a fundamental shift in the delivery of information technology (IT) services that have permanently changed the computing landscape. The main idea behind Cloud Computing is to consolidate and manage computing resources in higher education institutions, make them available to users anywhere and move maintenance and operational management burdens away from the enterprise to a third party.

Thus, the study deals with cloud computing and its effect on performance excellence at higher education institutions. In order to investigate the topic in more depth, researchers employed qualitative analysis.

The evolution of cloud computing

The advent of Computing revolutionized post-industrial society and Cloud Computing shows signs of revolutionizing the information society. Cloud Computing has been very often portrayed and perceived as a new technology but it is also widely accepted as evolution of technologies such as client server architecture, World Wide Web, and networking. Some even call it mainframe 2.0.

In 1960s mainframes were used for computing and transaction processing with users accessing the computing resources through 'dumb

terminals'. 1980s saw the advent of protocols for networking and client server architecture. "The ability to connect users to computing and data resources via standardized networks emerged as a key enabler of cloud computing" (The Defense Science Board).

The World Wide Web and the Internet followed in the 1990s along with enablers such as web browsers. The decade also saw the emergence of application service providers, offering software packages as service over the internet.

"Cloud computing has been enabled by the availability of broadband networks and inexpensive end-user devices, as well as commodity computing nodes that can be simply interconnected and controlled, and virtualization to provide the appearance of isolating processes that share computers" (The Defense Science Board).

Given the evolutionary nature of Cloud Computing, it could mean different things and thus it is prudent to pay attention to definition of Cloud Computing. "Cloud Computing is a model for enabling convenient, on-demand network access to a shared pool of configurable computing resources (e.g. networks, servers, storage, applications, and services) that can be rapidly provisioned and released with minimal management effort or cloud provider interaction" (Information Technology Laboratory - National Institute of Standards and Technology, 2004).

Cloud computing definition

Doelitzscher et al. (2011) report that despite the wide popularity of Cloud Computing, it is very difficult to provide a standardized clear definition for it. In fact, the definition of Cloud Computing, at best, can be described as imprecise and fuzzy as the edges of the cirrus clouds in the sky. On top, there is no standardized definition for its components as related to their roles. Kim (2009) defined Cloud Computing as "being able to access lies, data, programs and third party services from a web browser via the Internet that are hosted by a third-party provider" and "paying only for the computing resources and services you used".

Mell and Grance (2011) defined Cloud Computing as "a model for enabling ubiquitous, convenient, on-demand network access to a shared pool of configurable computing resources (e.g. networks, servers, storage, applications, and services) that can be rapidly provisioned and released with minimal management effort or service provider interaction".

The difficulty in reaching a clear-cut definition of Cloud Computing may be attributed to either its origination from many different network architectures or due to the vast services that it provides. Regarding its origin, Youseff et al. (2008) postulate that Cloud Computing inherits its concepts from peer-to-peer architecture, autonomic computing, virtualization and

service-oriented architecture (SOA). While Aymerich et al. (2008) state that the nascence of Cloud Computing as a new distributed computing paradigm a subset of grid computing technologies, which itself is an extension of cluster computing. Fox (2009) concludes that Cloud Computing is an extension of the client – server architecture introduced in the 1980s. Ironically, Kumar and Hsiang Lu (2010) report that Cloud Computing differs from client – server in the adoption of virtualization.

Cloud computing principles

Das (2013) argues that cloud computing has five key principles:

- (1) Shared resources (including applications, processors, storage and databases);
- (2) on-demand (users retrieve and use cloud information resources from the cloud);
- (3) Elasticity, flexibility and scalability (clouds are receptive to user needs);
- (4) Networked access (wide accessibility); and
- (5) Metering use (involve payments and storage efficiency).

Literature offers many Cloud Computing definitions. These definitions cover a spectrum of perspectives and come in various degrees of detail. Gartner's definition of cloud mentions scalability, elasticity, and delivery as service. Forrester's definition indicates abstraction, scalability, hosting and billing. IDC has likened Cloud Computing to emerging IT model, and mentions real-time delivery over the Internet. Communications of ACM differentiates between public and private clouds, and presents the view that cloud is datacentered hardware and software. NIST offers a detailed definition that talks about different types of computing resources, characteristics of Cloud Computing, and associated service modes and deployment models.

NIST: Cloud Computing is a model for enabling convenient, on-demand network access to a shared pool of configurable computing resources (e.g. networks, servers, storage, applications, and services) that can be rapidly provisioned and released with minimal management effort or cloud provider interaction (Information Technology Laboratory - National Institute of Standards and Technology, 2004).

Cloud Computing Benefits

There are Some benefits of cloud computing which are listed below:

Reduced Cost

There are a number of reasons to attribute Cloud technology with lower costs. The billing model is pay as per usage; the infrastructure is not

purchased thus lowering maintenance. Initial expense and recurring expenses are much lower than traditional computing.

Increased Storage

With the massive Infrastructure that is offered by Cloud providers today, storage & maintenance of large volumes of data is a reality. Sudden workload spikes are also managed effectively & efficiently, since the cloud can scale dynamically.

Flexibility

This is an extremely important characteristic. With enterprises having to adapt, even more rapidly, to changing business conditions, speed to deliver is critical. Cloud computing stresses on getting applications to market very quickly, by using the most appropriate building blocks necessary for deployment.

Cloud computing models

There are three primary service models. First, Software as a Service (SaaS),

Second, Platform as a Service (PaaS) provides supply tools and an enabling environment to universities to build, test, install and embrace their own software and web-based applications in the cloud.

Third, Infrastructure as a Service (IaaS) also referred to as Hardware as a Service (HaaS) that provides storage and computing services on many servers with an on-demand and “pay per use” formula. The other storage devices include Data Center, Bandwidth, Private Line Access, Servers and Server Room, Firewall and Storage space.

These models of cloud computing help institutions to perform tasks in an easy way with less effort. Thus, the performance is done in an excellent way.

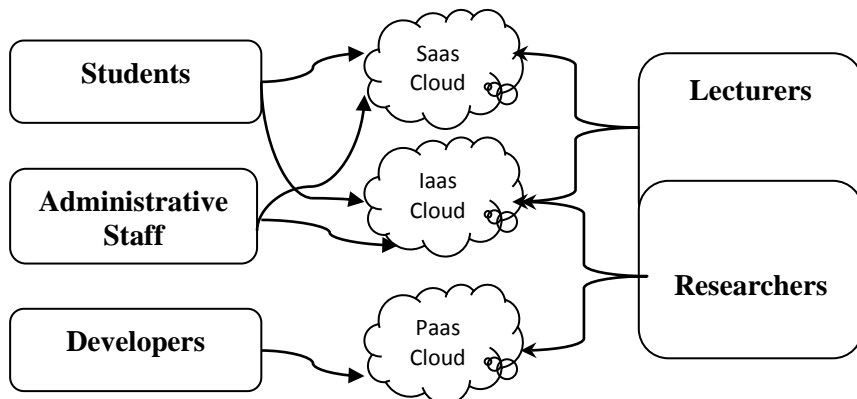

Fig 1: Simplified structure of the main user of IT services in a university using cloud computing models.

The challenges facing cloud computing

Cloud Computing introduces substantial new challenges. But, it also faces many of the same old challenges as conventional networks. In fact, the majority of these challenges are inherited from ascendant architectures such as grid computing, client/server and the semantic web. Some of the Cloud drawbacks negatively impact KM initiatives such as security, legal issues, information overload and cultural differences, but these are not entirely insurmountable complications. Some of them could be avoided by application of KM principles such as inter-organizational knowledge sharing, coordinating Cops, content management, building trust and expert profiles.

Information security

Cloud Computing security concerns have been expressed by Khan and Malluhi (2010), Borenstein and Blake (2011), Lakshminarayanan (2010) and Ortiz (2011). The trade-off between the Cloud's openness and the need for data protection has resulted in multiple paradox and major concerns in the form of knowledge assurance, information security and privacy. Knowledge is the most valuable competitive resource; therefore, having sensitive information resides in a third-party infrastructure, and accessibility from anywhere may not be tolerable by many security and KM practitioners. Due to open common architecture and multi-tenancy, the security problem of the Cloud is a compound one because if an agent breaks into a Cloud server or application, then that will potentially expose all of the client's sensitive data. As a result, Hurbean and Fotache (2013) found that ERP, CRM and other enterprise applications are still considered mission-critical systems, so they will probably remain on-premise or migrate only to the private Cloud. However, if the security measures for the public Cloud Computing are improved to the level of traditional networks, then organizations may better control the level of tolerable risk for their sensitive information. Pursuing this logic, Zaerens and Mannonen (2012) proposed an approach for evaluation, standardization and deployment of public Cloud networks with high security environment extended from the private Cloud architecture.

Information overload

There are concerns about the disproportionality in the knowledge continuum (data, information and knowledge), where there are huge data and information chunks, i.e. big data with mere knowledge. The danger and the frustration created by information overload has been reported by Godwin (2001), Jefferson (2006) and Mohamed (2007). Furthermore, Baqir and Kathawala (2004) state that the right combination of different technologies is crucial to managing knowledge sources of a learning organization, but it leads to information overload. Cloud Computing makes it easy and fast to

produce and store a glut of information. The information overload is usually reached when the judgmental decision is negatively impacted because the amount of information available in a short time is more than the decision maker's ability to process this information. The over-abundance of information affects the quality of decision through confusion, uncertainty and stretching the time horizon available for the decision-making process.

Cultural differences

1- There are many barriers to the deployment and usage of Cloud Computing, as one data center may span national and regional borders and cultures. Of its own accord, Cloud Computing creates a cultural imperialism that overarches all other existing organizational cultures. As it creates lat organizations, it also collides with some cultural barriers that may emerge during knowledge brokering. Although organizations may indeed be sui generis with their own intrinsic idiosyncrasy, cultural shifts happen when such new systems are released. For that reason, Cloud Computing may hatch its own radically different culture that disrupts everyday processes, along with a new set of transparency-related issues. It also disrupts the concrete manifestation of traditional managerial practices and philosophies. The following table summarizes the main benefits and limitations of cloud computing in higher education:

Table 1: Main benefits and limitations of cloud computing in higher education

Benefits	Limitations
Access to applications from anywhere	Not all applications run in cloud
Support for teaching and learning	Risks related to data protection and security and accounts managements
Software free for pay per use	Organizational support
24 hours access to infrastructure and content	Dissemination politics, intellectual property
Opening to business environment and advanced research	Security and protection of sensitive data
Protection of the environment by using green technologies	Maturity of solutions
Increased openness of student to new technologies	Lack of confidence
Increasing functional capabilities	Standards adherence
Offline usage with further synchronization opportunities	Speed/lack of internet can affect work methods

Performance excellence in higher education institutions

In recent years the nature of managerial work has changed in many organizations. As companies found themselves trying to compete in a world market characterized by, as Tom Peters puts it, continual chaos, companies that had traditionally been the most successful competitors found themselves losing market share. They had traditionally been successful as a result of

their ability to control costs through the use of bureaucracies and economies of scale but today successful companies must be able to respond quickly and effectively to change, and evoke high levels of employee commitment to goals such as innovation and quality.

As a result, institutions began to change their approach to management and began to focus on what Lawler (1988) has labeled “High Involvement Systems.” In these new systems employees were expected to assume the responsibility for performing tasks which traditionally had been considered management tasks— planning, decision making, and quality control, for ex- ample. Consequently, the number of middle level managers was reduced and many tasks which had traditionally been considered managerial tasks were delegated to employees. In addition, in order to maintain high levels of intrinsic motivation on the part of employees, the managers that remained were asked to abandon the traditional role of supervisor and assume the role of mentor. Instead of doing the planning, decision making and controlling themselves, managers were now expected to help their employees perform these tasks by acting as facilitators, coaches, and trainers.

This suggests that managers could improve their effectiveness as teachers and trainers by using a four step approach to training (Jerry M. Kopf Jerry G. Krauze, 1991):

2- **.Show them.** At this stage, employees are shown a sample of the desired objects, behaviors, or processes, which demonstrate the concept or principle the manager wishes to introduce. Samples may be obtained from direct experience, simulated situations, or examination of documents, materials or work products. The manager should then assist the employees in identifying the kinds of information or materials needed to perform the tasks, and how it should be organized and used. At the end of this stage, the manager should direct a discussion of what the results of the behavior are, and how these results are achieved. This stage helps employees relate the training to the desired outcomes. For example, assume a manager desires to train office/administrative employees on how to use computers in the context of their jobs. Rather than beginning immediately with commands and key-strokes, the manager should first illustrate how the computer can be used to perform specific tasks. For example, the manager might illustrate the use of a spreadsheet program to prepare a report currently being prepared by hand. The manager can initiate the discussion by distributing some computer outputs. The manager could elaborate how these reports/processes were accomplished prior to computerization, indicating the time and money savings generated by computerization and the reports/processes. Then, the manager could sit down at the computer, turn it on, bring up the spreadsheet, input some data, and print out the report. Finally, the manager could

talk in general terms about what had just been done what information was needed, what inputs were required, what software was used, etc.

3- **Tell them.** At this stage, employees should develop a step-by-step model of how to perform the task and how to achieve the desired results or outcomes. Participants should reflect upon the observations and discussion in Stage 1 and begin to form a structured model of the process involved. The trainer should focus on helping employees identify the stages of the process and what is done in each stage. Information should be provided in small chunks and new material should be tied in with previously learned information. The manager, for example, could begin with a discussion of how to turn a computer on, how to use the operating system to access the spreadsheet, how to enter data into a spreadsheet, etc. Complex tasks should be provided in discrete blocks, allowing time for the employee to go through all four stages of the learning cycle for each block. For example, employees should have a chance to see the operating system work, see what steps are involved in using the operating system, understand why they use a particular command, and have a chance to try and use the operating system before they are taught how to use the spreadsheet.

4- **Explain it to them.** The focus of this stage should be on developing a better understanding of why a task is performed in a certain way. At the end of this stage the trainee should not follow just a set of routine instructions, but be able to deal with unique situations. In this stage, the manager should provide actual examples and situations which require employees to come up with solutions. It is important that employees begin to understand the relationships and the logic or rationale involved. The manager could select additional examples which are unusual or different and which require employees to find innovative solutions. For example, the manager might ask the employee how they would use the same data in the spreadsheet to perform different calculations or prepare a different type of report. This stage should help employees understand why they are doing something, which not only promotes a better understanding of the task, but often a more positive attitude toward the task as well.

5- **Do It.** In this stage the person should try to perform the task themselves. People often think they understand how to perform a task, but when they try to do it they discover there are things they still don't understand. It is one thing to watch a pro tennis player serve the ball, and quite another thing to do it yourself! By actually performing the task people can discover for themselves what help they need, and the trainer can observe the trainee to see if they have misunderstood the task. This allows the trainer to provide immediate feedback and correct problems before they become bad habits. To use the spreadsheet example, the manager should select a task which can be completed through the use of a spreadsheet. By having the

employee actually perform the task, the manager is able to verify that the employee has successfully completed the preceding three stages of earning, or if they need to back up to an earlier stage. The manager should then ask employees to identify tasks within their area of responsibility which could be completed more effectively through the use of computer spreadsheets. The goal of this stage is to encourage employees to explore the computer's capabilities and to find new applications for the computer. Not only does this improve learning, but employees can be an important source of knowledge, since they often have more up-to-date technical information and a better understanding of day-to-day operations.

Performance excellence models

First: the 4P excellence model

In Dahlgaard-Park and Dahlgaard (2003, 2007) a model – the “4P” excellence model – is presented which has proven to be a good framework model to be used when educational institutions are planning to attain excellence. The model is consisting of five components which are as follow;

Products - Processes; and Leadership - people - Partnership

The main implication that can be drawn from this model is that excellent products and services are a result of building excellence into people, partnership and processes, and this requires a strong foundation – leadership. It is assumed that a management without such leadership will not be able to create excellence..

Peters and Austin's (1985) simplified organizational excellence model illustrates all these issues. They regarded excellence as being the result of the following four critical success factors (CSF):

- People, who practice
- Care of customers
- Constant innovation; and
- leadership

Second: Baldrige Education Criteria for Performance Excellence

While the Baldrige Award in education has captured the attention of decision makers, there has been little empirical research examining the usefulness of the award criteria to guide the actions of organizations that seek to improve performance (Goldstein and Schweikhart, 2002; Arif and Smiley, 2004).

Conclusion

Both researchers put a suggested proposal to fulfill performance excellence at higher education institutions in Egypt. The suggested proposal included its definition, philosophy, fundamentals, aims, guarantees and procedures.

The suggested proposal definition is based on a list of suggestions that handle the effect of cloud computing on fulfilling performance excellence at higher education institutions. The suggested proposal philosophy is that cloud computing leads to achieve excellence of performance.

The proposal fundamentals are: Performance excellence leads to carrying out tasks in the best way, the cloud computing increases the performance effectiveness at institutions, persons, customers, innovation and leadership are main elements to achieve excellence, and these elements are among the basic principles of cloud computing besides to the main fundamental that Performance excellence requires using unique and distinguished situations and awareness of adopting creative solutions of complicated tasks and this is the main aim of cloud computing.

The proposed aims are: setting awareness of cloud computing importance at higher education institutions in Egypt, guiding the stakeholders to review the policies of their performance to cope up with cloud computing, in addition to finding a mechanism to activate cloud computing at all fields in university institutions.

The proposal guarantees the following outcomes: (1) making exclusive changes to information technology programs at higher education institutions; (2) training the employees of these institution on how to use cloud computing in carrying out their tasks; (3) participation of all members in each institution at the development process; and (4) ensuring that the institutions networking environment is ready for cloud computing in addition to offering the necessary financial support to activate cloud computing at higher education institutions in Egypt.

To achieve the proposed aims, the following procedures were followed: (1) reviewing the use of cloud computing at higher education institutions; (2) providing the principles and employees at higher education institutions with the Knowledge of using and applying cloud computing and the way by which they can overcome its obstacles; (3) offering the good infrastructure of cloud computing services at higher education institutions; and (4) enabling individuals to do projects and organize work via cloud computing services. The following diagram shows the suggested proposal procedures to use cloud computing in achieving performance excellence at higher education institutions:

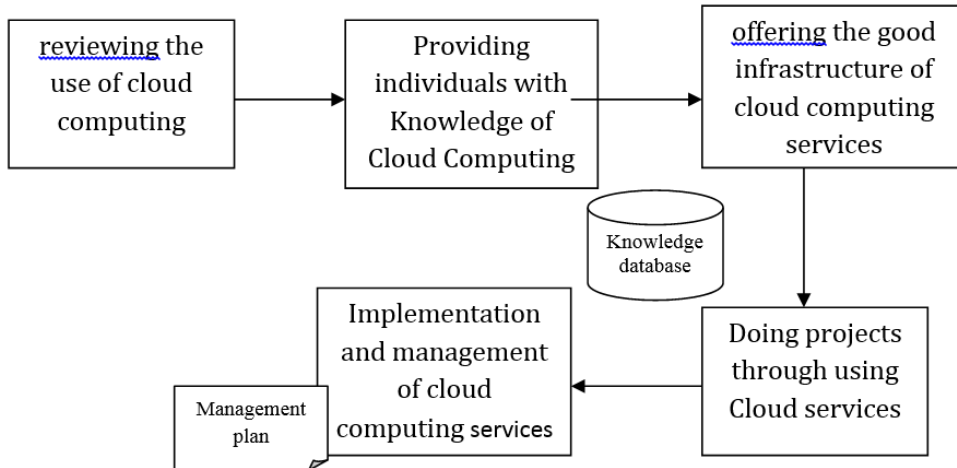

Fig 2: Implementation of Cloud Computing in Higher Education

References :

- Aymerich, M., Fenu, G. and Surcis, S., “An approach to a cloud computing network”, in ICADIWT 2008, First International Conference on the Application of Digital Information and Web Technologies, IEEE, Cagliari, 2008, pp. 113-118.
- Baqir, M.N. and Kathawala, Y. , "Ba for knowledge cities: a futuristic technology model", Journal of Knowledge Management, Vol. 8 No. 5, 2004, pp. 83-95.
- Bernstein, D., Ludvigson, E., Sankar, K., Diamond, S. and Morrow, M., "Blueprint for the intercloud - protocols and formats for cloud computing interoperability", in 200QFourth International Conference on Internet and Web Applications and Services, IEEE Computer Society, Venice, 2004, pp. 328-336.
- Bozzelli, T. , "Will the Public Sector Cloud Deliver Value? Powering the Cloud Infrastructure," CISCO. [Online], [Retrieved October 5, 2010],
- Dahlgaard-Park, S.M., “The European excellence model – an excellent model for management control?”, The Asian Journal on Quality, Vol. 4 No. 1, 2003, pp. 92-115.
- Dahlgaard-Park, S.M. , “Our dreams of excellence – learning from the past and architecting the future”, Journal of Management History, Vol. 13 No. 4, 2007 (special issue).
- Das, D.C. , “Impact of cloud computing in library services (PPT)”, available at: www.kiit.ac.in/centrallibrary/pdf/pdf_presentation/Impact_of_Cloud_Computing_on_Library_Services.pdf (accessed 7 July 2014).

- Doelitzscher, F., Sulistio, A., Reich, C., Kuijs, H. and Wolf, D. , "Private cloud for collaboration and e-Learning services: from IaaS to SaaS", Computing, Vol. 91 No. 1, 2013, pp. 23-42.
- Doelitzscher, F., Sulistio, A., Reich, C., Kuijs, H. and Wolf, D. , "Private cloud for collaboration and e-Learning services: from IaaS to SaaS", Computing, Vol. 91 No. 1, 2011, pp. 23-42.
- Fox, R. , "Digital libraries: the systems analysis perspective library in the clouds", International Digital Library Perspectives, Vol. 25 No. 3, 2009, pp. 156-161.
- Geczy, P., Izumi, N. and Hasida, K. , "Cloudsourcing: managing cloud adoption", Global Journal of Business Research (GJBR), Vol. 6 No. 2, 2012, pp. 55-70.
- Godwin, P. , "Learning and teaching - the librarian's contribution: an introduction", VINE: Information and Knowledge Management Systems, Vol. 31 No. 1, 2001, pp. 3-4.
- Hurbean, L. and Fotache, D. , "Mobile technology: binding social and cloud into a new enterprise applications platform", Informatica Economica, Vol. 17 No. 2, 2013, p. 73.
- Jefferson, T.L. , "Taking it personally: personal knowledge management", VINE: Information and Knowledge Management Systems, Vol. 36 No. 1, 2006, pp. 35-37.
- Jerry M. Kopf Jerry G. Krauze, , "Achieving Performance Excellence: Training the Trainer", American Journal of Business, Vol. 6, Iss 1, 1991, PP. 23-26.
- JOTHAM MILIMO WASIKE , "Opening libraries to cloud computing: a Kenyan perspective", Library Hi Tech News, Vol. 32 Iss 3, 2015, pp. 21 – 24
- Khan, K.M. and Malluhi, Q. , "Establishing trust in cloud computing", Computer, Vol. 12 No. 2, 2010, pp. 20-26.
- Kim, W. , "Cloud computing: today and tomorrow", Journal of Object Technology, Vol. 8 No. 1, 2009, pp. 65-72.
- Kumar, K. and Hsiang Lu, Y. , "Cloud computing for mobile users: can offloading computation save energy?", Computer, Vol. 43 No. 4, 2010, pp. 51-56.
- Lakshminarayanan, S. , "Interoperable security standards for web services", Computer, Vol. 12 No. 5, 2010, pp. 42-47.
- Lazowska, E., Lee, P., Elliott, C. & Smarr, L. , "Infrastructure for Esience and Elearning in Higher Education," Computing Community Consortium. [Online],[Retrieved October 5, 2010],<http://www.cra.org/ccc/docs/init/Infrastructure>
- Lloyd, A.D. and Sloan, T.M. , "Intercontinental grids: an infrastructure for demand-driven innovation", Journal of Grid Computing, Vol. 9 No. 2, 2011, pp. 185-200.

Mell, P. and Grance, T. , Special Publication 800-145: The NIST Definition of Cloud Computing, National Institute of Standards and Technology, Washington, DC,2011.

Mircea, M., "SOA, BPM and Cloud Computing: Connected for Innovation in Higher Education," 2010 International Conference on Education and Management Technology (ICEMT 2010), November 2-4, 2010, Cairo, Egypt, ISBN: 978-1-4244-8617-5;

Mohamed, M. , "Cyberinfrastructure: an emerging knowledge management platform", VINE: Information and Knowledge Management Systems, Vol. 37 No. 2, 2007, pp. 126-132.

Mona A. Mohammed Sharma Pillutla, "Cloud Computing: a collaborative green platform for the knowledge society", VINE, Vol. 44, Iss 3, 2014, PP. 357-374.

NIST , Education Criteria for Performance Excellence, National Institute of Standards and Technology, Gaithersburg, MD.http://www.cisco.com/web/strategy/docs/gov/2009_cloud_public_sector_tbozelli, 2004

Peters, T. and Austin, N. , A Passion from Excellence – The Leadership Difference, Harper Collins Publishers, London, 1985.

Srinivasan, S. and Getov, V. , "Navigating the cloud computing landscape - technologies, services, and adopters", Computer, Vol. 44 No. 3, 2011, pp. 22-23.

Srinivasan, S. and Getov, V. , “Navigating the cloud computing landscape – technologies, services, and adopters”, Computer, Vol. 44 No. 3, 2011, pp. 22-23.

Youseff, L., Butrico, M. and Da Silva, D. , “Toward a unified ontology of cloud computing”, in Grid Computing Environments Workshop, 2008 GCE '08, IEEE, Austin, Texas.

Zaerens, K. and Mannonen, J. , "Concept for the construction of high security environment in public authority Cloud", Embedded and Multimedia Computing Technology and Service, Springer, 2012.

BRAIN-COMPUTER INTERFACE: COMPARISON OF TWO CONTROL MODES TO DRIVE A VIRTUAL ROBOT

Ron-Angevin Ricardo, PhD

ETSI Telecomunicación, University of Málaga, Spain

Debeyre Aurélie

Marquet Yvan

ENSC, Bordeaux INP, France

Lespinet-Najib Véronique, PhD

Andre Jean Marc, PhD

Team CIH, Laboratory IMS CNRS UMR 5218, France

Abstract

A Brain-Computer Interface (BCI) is a system that enables communication and control that is not based on muscular movements, but on brain activity. Some of these systems are based on discrimination of different mental tasks; usually they match the number of mental tasks to the number of control commands. Previous research at the University of Málaga (UMA-BCI) have proposed a BCI system to freely control an external device, letting the subjects choose among several navigation commands using only one active mental task (versus any other mental activity). Although the navigation paradigm proposed in this system has been proved useful for continuous movements, if the user wants to move medium or large distances, he/she needs to keep the effort of the MI task in order to keep the command. In this way, the aim of this work was to test a navigation paradigm based on the brain-switch mode for 'forward' command. In this mode, the subjects used the mental task to switch their state on /off: they stopped if they were moving forward and vice versa. Initially, twelve healthy and untrained subjects participated in this study, but due to a lack of control in previous session, only four subjects participated in the experiment, in which they had to control a virtual robot using two paradigms: one based on continuous mode and another based on switch mode. Preliminary results show that both paradigms can be used to navigate through virtual environments, although with the first one the times needed to complete a path were notably lower.

Keywords: Brain-Computer Interface (BCI), virtual robot, switch mode, motor imagery (IM)

Introduction

A brain-computer interface (BCI) is based on the analysis of the brain activity, such as electroencephalographic (EEG) signals, recorded during certain mental activities, in order to control an external device. One of its main uses could be in the field of medicine, especially in rehabilitation. It helps to establish a communication and control channel for people with serious motor function problems but without cognitive function disorder (Wolpaw, Birbaumer, McFarland, Pfurtscheller & Vaughan, 2002). Amyotrophic lateral sclerosis (ALS), brain or spinal cord injury, cerebral palsy and numerous other diseases impair the neural pathways that control muscles or impair the muscles themselves. Some patients suffering this kind of diseases can neither communicate with the outside world nor interact with their environment. In this case, the only option is to provide the brain with a new and non-muscular communication and control channel by means of a BCI.

EEG activity includes a variety of different rhythms that are identified by their frequency and their location. Mu (7-13Hz) and central beta (18-26Hz) rhythms are focused over sensorimotor cortex and recorded from the scalp over central sulcus. Sensorimotor rhythm-based BCIs (SMR-BCI) are based on the changes in mu and beta rhythms, which can be modified by voluntary thoughts through such specific mental tasks as motor imagery (MI), (Kübler & Müller, 2007); i.e. when a person performs a movement (or merely imagines it), it causes a synchronization/desynchronization in the neuron activity (event related synchronization/desynchronization, ERS/ERD) which involves a mu rhythm amplitude change (Neuper & Pfurtscheller, 1999). This relevant characteristic is what makes SMR suitable to be used as input for a BCI.

Many BCI applications based on mental task discrimination allow the user to control simulated (Tsui, Gan & Roberts, 2009) or real mobile robots (Barbosa, Achanccaray, Meggiolaro, 2010), (Millán, Renkens, Mourino, & Gerstner, 2004). The vast majority of BCI system to control external device match the number of commands to the number of mental tasks. Having a higher number of commands implies higher information throughput and makes it easier for the subjects to navigate through the environment, since they have more choices to move. However, some studies proved that the best classification accuracy is achieved when only two classes are discriminated (Kronegg, Chanel, Voloshynovskiy, & Pun, 2007).

One of the main objectives of the BCI research at the University of Málaga (UMA-BCI) is to provide a BCI system to freely control an external

device (robot, wheelchair) based in the discrimination of only two classes. To obtain this objective, different paradigms have been proposed. In (Ron-Angevin, Velasco-Álvarez, Sancha-Ros & Da Silva-Sauer, 2011), subjects performed one MI task to extend a rotating bar that pointed to four possible commands in order to select them; two mental tasks are mapped this way into four navigation commands, allowing carry out discrete movements. On a later experiment (Velasco-Álvarez, Ron-Angevin, Da Silva-Sauer & Sancha-Ros, 2010), the same navigation paradigm was used to provide continuous movements: after the selection of a command, the movement was kept while the MI task was above certain threshold. Both paradigms have been used to control a virtual and a real robot (Ron-Angevin, Velasco-Álvarez, Sancha-Ros & Da Silva-Sauer, 2011), (Velasco-Álvarez, Ron-Angevin, da Silva-Sauer & Sancha-Ros, 2013), and a virtual (Velasco-Álvarez, Ron-Angevin, Da Silva-Sauer & Sancha-Ros, 2010) and real wheelchair (Varona-Moya et al., 2015).

Although a wheelchair controlled through a BCI system should provide continuous movements, in some situations this paradigm could have some disadvantages. If the user wants to move forward during a long period in order to cover medium or long distances, he/she needs to keep the effort of the MI task in order to keep the virtual wheelchair moving forward. A smart solution to this problem could be to apply the concept of a *Brain-Switch* (Mason, & Birch, 2000) to this paradigm. A BCI based on a brain-switch offers only an on/off control and only distinguishes between a predefined state and one specific mental task, therefore it fits the paradigm operating mode. In this way, for large distance, instead of keeping the ‘forward’ command active continuously, this one could be activated by a switch control. Once the subject decides to stop the movement, he/she deactivates the ‘forward’ command through another switch control action. This approach has been used by others BCI groups (Solis-Escalante, Müller-Putz, Brunner, Kaiser & Pfurtscheller, 2010), (Müller-Putz, Kaiser, Solis-Escalante & Pfurtscheller, 2010).

The aim of the present study is to check the usefulness of this brain-switch mode for controlling a virtual robot. In order to obtain comparative results, subjects also control the virtual robot in continuous mode.

Methods

Subjects and Data acquisition

Twelve naïve subjects (aged 21.5 ± 2.2 years) participated in the study. As a design criterion, a maximum value of 30% in the error rate was considered to allow an efficient control of the paradigm. In the present study, only subjects who performed under this threshold in the calibration session (see section 2.2) continued with the navigation sessions. Finally, six out of

the twelve subjects accomplished this criterion, being the others six subjects discarded due to their lack of control in the training sessions.

The EEG was recorded using gold disc electrodes from two bipolar channels over left and right central areas. Channels were derived from two electrodes placed 2.5cm anterior and posterior to positions C3 and C4 (right and left hand sensorimotor areas, respectively) according to the 10/20 international system. The ground electrode was placed at the FPz position. Signals were amplified by a 16 channel biosignal g.BSamp (Guger Technologies) amplifier and then digitized at 128 Hz by a 12-bit resolution data acquisition NI USB-6210 (National Instruments) card.

Initial training and signal processing

Before using the system to test the two paradigms, subjects had to follow an initial training that consisted of two sessions: a first one without feedback and a second one providing continuous feedback. As we have indicated in the previous section, those subjects who obtained a low error rate in the first session continued with the experiment. These two training sessions were used for calibration purposes.

This training used the paradigm proposed by our group (UMA-BCI) in (Ron-Angevin & Díaz-Estrella, 2009), based on that proposed by the Graz group (Guger et al., 2001), in which subjects immersed in a virtual environment (VE) had to control the displacement of a car to the right or left, depending on the mental task carried out, in order to avoid an obstacle (a puddle), see Fig. 1. The training entailed discriminating between two mental tasks: mental relaxation and imagined right hand movements (right hand MI). The subjects did not receive any feedback in the first session, which was used to set up classifier parameters for the second session, in which continuous feedback was provided. In this first session, subjects were instructed to carry out four experimental runs consisting of 40 trials each. After a break of 5–10 min, the time necessary to do the offline processing (see (Ron-Angevin & Díaz-Estrella, 2009) for details) to determine the parameters for the feedback session, subjects participated in the second session. This feedback session consisted of one experimental run, intended to check the effectiveness of the chosen parameters and the ability of the subject to control his or her EEG signals.

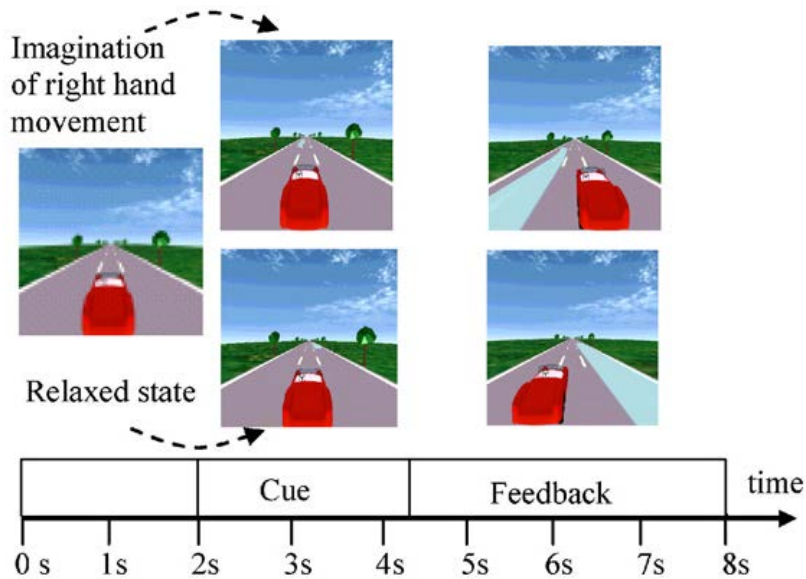

Figure 1: Timing of one trial of the training with feedback.

The same parameters obtained were used to calibrate the system for the virtual environment (VE) navigation sessions. This processing is based in the procedure detailed in (Pfurtscheller, 2003), and consisted of estimating the average band power of each channel in predefined, subject-specific reactive frequency (manually selected) bands at intervals of 500 ms. In the feedback session, the movement of the car was computed on-line every 31.25 ms as a result of a Linear Discriminant Analysis (LDA) classification. The trial paradigm and all the algorithms used in the signal processing were implemented in MATLAB.

Navigation Paradigm

The main objective of the BCI research at the University of Málaga is to provide an asynchronous BCI system (UMA-BCI) which, by the discrimination of only two mental states, offers the user several navigation commands to be used in a VE. An asynchronous (or self-paced) system must produce outputs in response to intentional control as well as support periods of no control (Schlögl, Kronegg, Huggins, & Mason, 2007); those are the so-called intentional control (IC) and non-control (NC) states, respectively. Both states are supported in the study presented in this paper: the system waits in a NC state in which an NC interface is shown (Fig. 2a). The NC interface enables subjects to remain in the NC state (not generating any command) until they decide to change to the IC state, where the control is achieved through the IC interface (Fig. 2b).

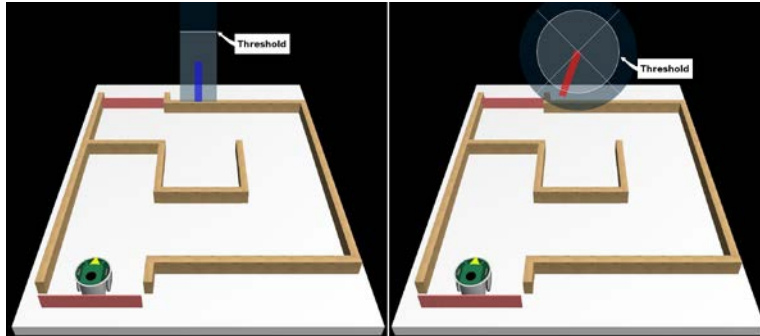

Figure 2: a) NC interface (left) and b) IC interface (right)

The NC interface consists of a semi-transparent vertical blue bar placed in the centre of the screen. The bar length is computed every 62.5 ms as a result of the LDA classification: if the classifier determines that the mental task is right-hand MI, the bar extends; otherwise, the bar length remains at its minimum size. In order to change from the NC to the IC state, the subject must accumulate more than a “selection time” with the bar over the “selection threshold”. If the length is temporarily (less than a “reset time”) lower than the selection threshold, the accumulated selection time is not reset, but otherwise it is set to zero.

The IC interface is similar to the one presented in (Ron-Angevin, Díaz-Estrella, & Velasco-Álvarez, 2009): a circle divided into four parts, which correspond to the possible navigation commands (move forward, turn right move back and turn left), with a blue bar placed in the centre of the circle that is continuously rotating clockwise. The subject can extend the bar carrying out the MI task to select a command when the bar is pointing at it. The way the selection works in this interface is the same as in the NC interface, with the same selection and reset time and the same selection threshold. In the IC interface, another threshold is defined: stop threshold, which is lower than the selection threshold, and not visible to the subject. When it is exceeded, the bar stops its rotation in order to help the subject in the command selection. The rotation speed was fixed to 24 degrees every second, so it took 9 s to complete a turn if there was not any stop.

Subjects receive audio cues while they interact with the system. When the state changes from IC to NC they hear the Spanish word for ‘wait’; the reverse change is indicated with ‘forward’, since it is the first available command in the IC state. Finally, every time the bar points to a different command, they can hear the correspondent word (‘forward’, ‘right’, ‘backward’ or ‘left’).

In the next two sections, the two paradigms to be compared will be described, which are based in the interfaces explained above.

1) Continuous Mode

Once a command is selected, the bar changes its color to red and the virtual robot starts moving forward or backward, or turning left or right at a fixed speed. The movement is maintained as long as the bar length is above the selection threshold (this means that the subject is still carrying out the MI mental task). If the bar is temporarily under this threshold (less time than the reset time), the movement stops, but the system allows the subject to continue the same movement if the bar again exceeds the selection threshold. While it happens, the bar keeps its red color to indicate this possibility to the subject. In the case that the bar remains under the selection threshold longer than the reset time, the bar changes its color to blue and continues rotating (if it is under the stop threshold) so that the subject can select a command again. The position of the rotating bar does not change; it takes its rotation up again from the same point at which it last stopped to select a command. In this way, the subject can select the same command several times in a row, in case the reset time passes without the subject wanting to stop the movement.

2) Switch Mode

Once a command is selected, the movement starts (as it happened in the previous case) and the bar color is set to green. The main difference is that, in the present case, when the bar is shortened under the selection threshold the movement does not stop, but it is kept until the user enlarges the bar length above the selection threshold again (carrying out a MI mental task); at that moment the robot stops. Besides, as it was the case of a command selection, if the bar still remains above the threshold for the same “selection time”, the command is unselected and the bar turns blue and continues its rotation. If the time that the bar is above the threshold is lower than the “selection time”, the movement of the robot starts again.

Experimental Procedure

This experiment consisted of controlling a virtual robot through a group of corridors which formed a sort of small maze. This proposed virtual robot was designed with the same features as the EPFL educational e-puck robot, (www.e-puck.org). The task was to drive the virtual robot from the start position to the goal as fast as possible, using the minimum number of navigation commands, trying to always move forward (the forward direction is indicated by an arrow on the top of the robot), and avoiding collisions. The proposed VE (and the virtual robot) is presented in Fig. 2. The robot was configured to stop automatically when they approached within 2 cm of an obstacle, to move at a speed of 3.9 cm/s, and to turn at 42.9 degrees/s. The VE was created with OpenGL for the graphics, OpenAL for the 3D audio, and ODE for physics simulation. The C programming language was used. Interaction between MATLAB and the VE was achieved with TCP/IP

communications, which allowed us to use different machines for data acquisition and processing, and environment simulation and display.

Each subject participated in four sessions, carried out on different days: a first one for adaptation purpose and the other three to evaluate the two different paradigms. The first session was considered an adaptation to the paradigm navigation session, in which subjects should get familiarized with the environment and the navigation paradigm using only the audio-cued interface. After a short training period controlling the virtual robot using the graphical and the audio-cued interfaces together, the subjects practiced to control it through using only the audio-cue interface. The duration of this first session was depending on the ability of the subject to acquire control (30-60 min). Due to a lack of control, two out of six subjects were discarded and did not participate in the rest of the experiment. Finally, four out of twelve subjects participated in the all experiment.

After this first session, the four subjects participated in three sessions, with two experimental runs each. During the two first experimental sessions (denoted session 1 and session 2), the first experimental run consisted of controlling the virtual robot using discrete mode for turn commands: once the command is selected, the virtual robot turn 90 degrees to the right or to the left. In the second experimental run, continuous mode was used to turn right and left. In the last session (denoted session 3), each experimental run was performed to control the robot using the two navigation paradigms, using continuous mode for turn commands. The order in which the navigation paradigms were tested was counterbalanced over participants in order to control for the potential effect of experience.

After each session, the participant filled out a usability questionnaire based on the NASA-TLX test (Hart, & Staveland, 1998). This questionnaire consisted of 5 affirmative statements: mental and temporal demands, fatigue/effort, stress and performance, scored between 0-20 in which higher values are indicative of higher workload.

Results

In table 1, the values of different parameters obtained from each session are shown. The nomenclature used in 'Run' parameter is: 'S': switch mode; 'C': continuous mode; 'd': discrete mode for turn commands; 'c': continuous mode for turn commands. The analyzed parameters are: the time in seconds necessary to generate the desired trajectory (Time), the number of times that the robot collided with the wall (Coll.), the number of selected commands of each type (Forward, Right, Left, and Backward) and the total number of commands used to drive the robot from the start position to the goal (Total). Rows in italics correspond to not finished runs (S/c for S1; C/d, C/c and S/c for S3). For these runs, subjects did not get to drive the robot to

the goal position, and was the operator who decided to stop the run when he considered it too long. In the last rows (indicated by ‘All’), the values averaged over the subjects for each mode are shown. To obtain these values, only finished runs were considered. ‘S’ and ‘C’ correspond to the average over all ‘Switch’ and ‘Continuous’ experimental runs respectively.

Subj	Ses	Run	Time (s)	Coll.	Forward	Right	Left	Backward	Total
S1	1	S/d	910	7	7	12	12	14	45
		S/c	1487	38	37	22	16	13	88
	2	C/d	228	1	5	2	2	0	9
		C/c	382	9	6	6	9	5	26
	3	S/c	640	6	11	13	9	10	43
		C/c	686	3	4	9	9	11	33
S2	1	C/d	334	7	8	5	5	9	27
		C/c	228	1	7	2	3	3	15
	2	S/d	860	16	14	18	26	9	67
		S/c	394	18	18	6	4	11	39
	3	S/c	492	5	6	10	7	6	29
		C/c	442	2	7	5	6	4	22
S3	1	C/d	1635	20	45	37	35	39	156
		C/c	644	2	38	18	16	9	81
	2	S/d	960	1	2	14	14	7	37
		S/c	570	3	4	5	21	5	35
	3	C/c	1107	17	30	27	31	17	105
		S/c	2609	73	62	92	69	69	292
S4	1	S/d	310	0	1	2	2	0	5
		S/c	1916	38	38	55	53	37	183
	2	C/d	2390	14	34	13	12	18	77
		C/c	308	0	15	6	3	0	24
	3	S/c	1229	0	31	11	15	2	59
		C/c	202	1	8	2	5	0	15
All	S/d		760±302.7	6±7.3	6±5.9	11.5±6.8	13.5±9.8	7.5±5.8	38.5±25.6
		S/c	873.5±589.1	11.6±14.3	18±13.8	16.6±19	18.1±18.1	11.8±12.7	64.6±58.8
	S	828.6±476.2	9.4±11.8	13.2±12.5	14.6±14.9	16.3±14.8	10.1±10.3	54.2±48.2	
	C/d	984±1218.8	7.3±6.5	15.6±15.9	6.6±5.7	6.3±5.1	9±9	37.6±35.2	
	C/c	413.1±191.2	2.57±2.9	12.1±11.9	6.8±5.5	7.3±4.6	4.6±4.2	30.8±22.9	
	C	584.4±656.1	4±4.5	13.2±12.4	6.8±5.2	7±4.5	5.9±5.8	32.9±25.3	

Table 1: Performance for each subject and session.

Regarding the subjective measures, the average values over the subjects and runs for each mode and question are shown in table 2. To obtain these values, only scores of finished runs were considered.

Mode	Questions				
	Mental demand	Temporal demand	Fatigue/effort	Stress	Performance
Switch	14.4±1.6	5.5±3.9	12±3.2	8.6±5.4	10.7±4.9
Continuous	12.3±5.1	4.6±4.2	12.3±3.5	7.9±6.4	13.4±4

Table 2: Subjective measures.

Discussion and Conclusion

The main objective of this study was to compare two different paradigms to control a virtual robot. Unfortunately, eight out of twelve subjects were discarded due to their lack of control (six subjects in the training sessions, and two subjects in the experimental phase). The number of participants is too low to obtain strong conclusions. However, the objective of this work was to test the feasibility of the navigation paradigms, and this has actually been proved with the satisfactory results of a small group of subjects.

The obtained results for continuous mode are in concordance with those obtained in a similar experiment (Velasco-Álvarez, Ron-Angevin, da Silva-Sauer & Sancha-Ros, 2013). Even if questionnaire results do not show significant differences between both control mode (table 2), comparing average values in the different parameters related to performance (data in bold in table 1), we can conclude that using the continuous paradigm it was easier to control the virtual robot (less time, collisions and commands). Although the number of 'forward' commands are very similar for both control mode, a high number of collisions for switch mode control has probably induced an increase in the rest of commands (in order to recover the path) and, consequently, in time.

One reason to explain these high values in controlling the virtual robot when using the switch mode control could be the difficulty for the subject to manage the brain-switch mode. As it is suggest in (Müller-Putz, Kaiser, Solis-Escalante & Pfurtscheller, 2010), brain-switch is usually controlled by the post-movement beta rebound found after foot movement imagery. In our work, subjects use motor imagery hand because is more appropriate for continuous control, being necessary for turn commands.

For further studies, it could be interesting to combine both mental tasks for both control modes: continuous and switch.

Acknowledgement

This work was partially supported by the University of Málaga, by the Spanish Ministry of Economy and Competitiveness through the project INCADI (TEC 2011-26395), by the European Regional Development Fund (ERDF). This project benefited from specific funding through The Excellence Initiative of the University of Bordeaux (IdEx Bordeaux). We would like to thank the volunteers for their time and contribution to the experiment.

References:

- Barbosa, A.O, Achancaray, D.R., & Meggiolaro, M.A. (2010). Activation of a mobile robot through a brain computer interface. In Proceedings of *IEEE Int. Conf. on Robotics and Automation (ICRA)*.
- Guger, C., Schlögl, A., Neuper, C., Walterspacher, D., Strain, T., & Pfurtscheller, G. (2001). Rapid prototyping of an EEG-based brain compute interface (BCI). *IEEE Transactions on Neural Systems and Rehabilitation Engineering*, 9(1), 49-58.
- Hart, S.G., & Staveland, L.E. (1998). Development of NASA-TLX (Task Load Index): Results of empirical and theoretical research. *Advances in psychology*, 52, 139-183.
- Kronegg, J, Chanel, G., Voloshynovskiy, S., & Pun, T. (2007). EEG-based synchronized brain-computer interfaces: a model for optimizing the number of mental tasks, *IEEE Transaction on Neural System Rehabilitation Engineering* 15 (1), 50-58.
- Kübler, A., & Müller, K.R. (2007). An introduction to brain-computer interfacing. G. Dornhege, J. d. R. Millán, T. Hinterberger, D. J. McFarland, & K. R. Müller (Eds.). *Toward Brain-Computer Interfacing* (pp. 1-25). Cambridge, England.
- Mason, S.G., & Birch G.E. (2000). A brain-controlled switch for asynchronous control applications. *IEEE Transactions on Biomedical Engineering* 47, 1297-1307.
- Millán, J.R., Renkens, F., Mourino, J., & Gerstner, W (2004). Non invasive brain-actuated control of a mobile robot by human EEG. *IEEE Transactions on Biomedical Engineering* 51 (6), 1026-1033.
- Müller-Putz, G., Kaiser, V., Solis-Escalante, T., & Pfurtscheller, G. (2010). Fast set-up asynchronous brain-switch based on detection of foot motor imagery in 1-channel EEG. *Medical & Biological Engineering & computing* 44(3), 229-233
- Neuper, C., & Pfurtscheller, G. (1999). Motor imagery and ERD. In G. Pfurtscheller, & F. H. Lopes da Silva (Eds.). *Event-Related Desynchronization. Handbook of Electroencephalography and Clinical Neurophysiology* (pp. 303-325). Elsevier. Amsterdam.
- Pfurtscheller, G. (2003). How many people are able to operate an EEGbased brain-computer interface (BCI)? *IEEE Transactions on Neural Systems and Rehabilitation Engineering* 11(2), 145-147.
- Ron-Angevin, R., & Díaz-Estrella A. (2009). Brain-computer interface: Changes in performance using virtual reality techniques. *Neuroscience Letters*, 449(2), 123-127.
- Ron-Angevin, R., Díaz-Estrella A., & Velasco-Álvarez, F. (2009). A two-class brain computer interface to freely navigate through virtual worlds. *Biomedizinische Technik*, 54(3), 126-133.

- Ron-Angevin, R., Velasco-Álvarez, F., Sancha-Ros, S., & Da Silva-Sauer, L. (2011). A two-class self-paced BCI to control a robot in four directions. In Proceedings of the *IEEE Int. Conf. on Rehabilitation Robotics (ICORR)*.
- Schlögl, A., Kronegg, J., Huggins, J.E., & Mason, S.G. (2007). Evaluation criteria for BCI research. In G. Dornhege, J. d. R. Millán, T. Hinterberger, D. J. McFarland, & K. R. Müller (Eds.). *Toward Brain-Computer Interfacing* (pp. 327-342). Cambridge, England.
- Solis-Escalante, T., Müller-Putz, G., Brunner, B., Kaiser, V., & Pfurtscheller, G. (2010). Analysis of sensorimotor rhythms for the implementation of a brain switch for healthy subjects. *Biomedical Signal Processing and Control* 5(1), 15-20.
- Tsui, C.S., Gan, J.Q., & Roberts S.J. (2009). A self-paced brain-computer interface for controlling a robot simulator: an online event labelling paradigm and an extended kalman filter based algorithm for online training. *Medical & Biological Engineering & computing* 47(3), 257-265.
- Varona-Moya, S., Velasco-Álvarez, F., Sancha-Ros, S., Fernández-Rodríguez, A., Blanca, M.J., & Ron-Angevin, R. (2015). Wheelchair Navigation with an Audio-cued, Two-Class Motor Imagery-based Brain-Computer Interface System. To be presented at Int. Conf. on *IEEE EMBS Neural Engineering Conference*.
- Velasco-Álvarez, F., Ron-Angevin, R., Da Silva-Sauer, L., & Sancha-Ros, S. (2010). Brain-computer interface: Comparison of two paradigms to freely navigate in a virtual environment through one mental task. In Proceedings of the *Int. Conf. on Broadband and Biomedical Communication (IB2Com)*.
- Velasco-Álvarez, F., Ron-Angevin, R., da Silva-Sauer, L. & Sancha-Ros, S., (2013). Audio-cued motor imagery-based brain-computer interface: Navigation through virtual and real environments. *Neurocomputing* 121, 89-98.
- Wolpaw, J.R., Birbaumer, N., McFarland, D.J., Pfurtscheller, G., & Vaughan, T.M. (2002). Brain-computer interfaces for communication and control. *Clinical Neurophysiology* 113(6), 767-791.

WOMEN'S PERCEPTION OF THE ACTUALISATION OF THE 5TH MDG (REDUCTION OF MATERNAL MORTALITY): A STUDY OF PREGNANT WOMEN IN IMO STATE, NIGERIA.

Nkem Fab-Ukozor, PhD

Department of Mass Communication, Imo State University, Owerri, Nigeria

Agwu A. Ejem, M.Sc

Department of Mass Communication, Maurid Polytechnic,
Afaha Nsit Akwa Ibom State, Nigeria

Abstract

Goal number five of the Millennium Development Goals (MDG), reduction of maternal mortality, had always represented a major challenge for Nigerian women. As the deadline for the actualization of the goals approaches, this study examined Nigerian women's perception of the attainment of the target goal. Pregnant women registered in health facilities in Imo State, Nigeria, were purposively studied. For this study, 210 pregnant women were sampled in 21 (5%) out of the 416 documented health facilities in the State. Using data gathered over a sampling period of 11 days by means of questionnaire and oral interview, analyses were done using a combination of qualitative and quantitative methods. The analyses found out that Nigeria was making progress in reducing maternal mortality rates, but the pace still remains too slow, as there are still many instances of deaths related to childbirth. Factors responsible for the slow progress were given as low ratio of births attended by skilled health workers, especially in rural areas; unfortunate attitudes to antenatal and postnatal care, poor state of health/medical infrastructure, etc. This study recommended the need for Nigeria to declare primary health care as a national emergency in 2015 and implement policies that will bring about structural change in the health sector and behavioural change among pregnant women.

Keyword: Millennium development goals, maternal mortality, Nigerian women

Introduction

Reports indicate that women are a vital part of the Nigerian population. Amnesty International (2006) reported that women make up more than 50% of the Nigerian population. The National Population Commission (2006) puts the female population in Nigeria at about 49% percent, and the World Bank (2013) states that the population of women in Nigeria was 49.1% of the total population. The implication is that women make up about half of the Nigerian population. According to Moser (1993), the women account for about 60 – 80% of the agricultural labour force. They produce most of the food items consumed in Nigerian homes. The women produce up to 80% of essential food stuffs and bear more than 90% of the domestic production tasks. Apart from their economic tasks, Odeh (2014) described women in Nigeria as having the biological and social tasks of bearing, nurturing, and providing initial education for children and ensuring the well-being of the family and that of the entire society; the women are the givers and nurturers of life. However, the expected contributions of women to development have been marred by some challenges faced by the female in Nigeria. One of them is a woman's chance of dying from pregnancy and childbirth in Nigeria mostly from preventable causes, as the coverage and quality of health care services in Nigeria continue to be on the radar.

The well-being of women was one of the high points of the Millennium Development Goals (MDGs). Goal number five of the Millennium Development Goals, reduction of maternal mortality or improvement of maternal health, particularly concerns the well-being of women. The target of the goal is to reduce by three quarters, between 2000 and 2015, the maternal mortality ratio and the proportion of births attended by skilled health personnel as well as achieve, by 2015, universal access to reproductive health, such as contraceptive prevalence rate, adolescent birth rate, antenatal care coverage, and unmet need for family planning (MDG Monitor, 2012).

Goal number five had always represented a major challenge for Nigerian women, and women in other developing nations. There have been efforts at the national and global levels to track the achievement of the 5th MDG and other goals. The 2010 MDG Report stated that progress towards goal number five was promising and, if the improvements could be sustained at the same rate, Nigeria would reach the target by 2015. Few years down the line, with the deadline for actualization of the goal around the corner, how have the improvements been sustained and where does Nigeria stand in terms of maternal health? Also, because of the direct bearing of the goal on women, this study, therefore, examined Nigerian women's perception of the attainment of the target goal from the point of view of pregnant women in Imo State, Nigeria.

Objectives

The broad objective of this paper was to examine Nigerian women's perception of the attainment of the MDG goal of reduction of maternal mortality or improvement of maternal health. From the point of view of pregnant women in Imo State, Nigeria, this study specifically sought to:

1. examine the perception of pregnant women in Imo State about the state of maternal health in Nigeria;
2. find out the view of pregnant women in Imo State about the extent of improvement, if any, in the state of maternal health in the country between 2000 and 2015;
3. find out the level of confidence reposed in the state of maternal health in the Nigeria by pregnant women in Imo State; and
4. know the perception of pregnant women in Imo State regarding the factors that have affected the state of maternal health in the country between 2000 and 2015.

Research questions

The research questions guiding this study are:

1. What is the perception of pregnant women in Imo State about the state of maternal health in Nigeria?
2. What is the view of pregnant women in Imo State about the extent of improvement, if any, in the state of maternal health in the country between 2000 and 2015?
3. What level of faith do pregnant women in Imo State place in the state of maternal health in Nigeria?
4. What do pregnant women in Imo State consider the factors that have affected the state of maternal health in the country between 2000 and 2015?

Literature review

Millennium Development Goals (MDGs) in Nigeria

Nigeria ventured into the Millennium Development Goals (MDGs) immediately after the United Nations Millennium World Summit in September 2000. Just like the rest of the developing nations, the Millennium Development Goals (MDGs) represent a worldwide collaborative effort set to put the wheels of national development in motion in Nigeria. According to a Mid-Point Assessment report of the Millennium Development Goals in Nigeria (2000-2007) published in 2008 by the Government of the Federal Republic of Nigeria, following the Millennium Declaration of 2000, Nigeria began the systematic implementation of several policies and programmes to help it attain the different targets set for the MDGs by 2015. Over the years, stakeholders have modified a few targets and refocused them to reflect local peculiarities as well as target more specific and measurable problems.

Odeh (2014) asserts that the first major development policy introduced by the federal government of Nigeria after the Millennium Declaration was the National Economic Empowerment and Development Strategy (NEEDS). SEEDS and LEEDS were the corresponding strategies at state and local government levels respectively. Although they were not developed exclusively for the MDGs, many of the targets in NEEDS and SEEDS were aligned with the MDGs. Nigeria's venture into the Millennium Development Goals (MDGs) immediately after the United Nations Millennium World Summit led to the establishment of the Office of the Senior Special Assistant to the President on MDGs (OSSAP-MDG) to guide the resources that would be freed up from the debt deal to MDG-related projects and programmes, whilst at the same time tracking, monitoring and evaluating their progress.

However, the prospects of the country attaining the goals have been severally questioned by the citizens, policy makers and scholars. According to Igbuzor (2011), the 2004 report which was Nigeria's first report on the MDGs states that "based on available information it is unlikely that the country will be able to meet most of the goals by 2015 especially the goals related to eradicating extreme poverty and hunger, reducing child and maternal mortality and combating HIV/AIDS, malaria and other diseases" (Millennium Development Goals Report 2004, p. iv). It further states that "for most of the other goals (i.e apart from goal 1) up-to-date data exists which shows that if the current trend continues, it will be difficult for the country to achieve the MDG targets by 2015" (Millennium Development Goals Report 2004, p. v).

Only less than 20 months to the deadline, the then President Goodluck Jonathan seemed to get into a 'panic mode' and directed the office of the Senior Special Assistant on Millennium Development Goals, MDGs, to work with the Governors of the 36 states of the Federation to ensure that they meet the targets before May 2015.

Goal Number 5 of the Millennium Development Goals (MDGs)

Out of the eight MDGs, the document expressly stated as its third and fifth goals, the pledge to promote gender equality, empower women and ensure their mental and physical well-being (Igbuzor, 2011). The fifth goal is of particular interest to this paper. The fifth goal is to improve maternal health, reduce by three quarters by 2015, reduce the proportion of women dying in childbirth and increase the proportion of births attended by skilled health personnel. The other targets of the goal are to achieve, by 2015, universal access to reproductive health, in terms of contraceptive prevalence rate, adolescent birth rate, antenatal care coverage, and unmet need for family planning (MDG Monitor 2012). It is reported that goal number

five is relatively receiving more attention than the rest of the MDGs as the deadline approaches. The British Council (2012) says that there has been a focus basically on maternal mortality because it is the only MDG where the least progress has been made.

In Nigeria, various policy initiatives have been introduced by the Federal Government in response to the health challenges facing Nigeria's women and to achieve the fifth MDG. According to British Council (2012), the policy initiatives include among others:

i. The National Health Policy revised in 2004 to provide a link to the Millennium Development Goals and the National Economic Empowerment Development Strategy (NEEDS).

ii. The National Reproductive Health Policy and Strategy 2001, which aimed to reduce pre- and neo-natal morbidity by 30%.

iii. The National HIV/AIDS Policies and Strategic Plan 2003, which provided an integrated approach to addressing transmission of the HIV virus from mother to child, among other measures.

iv. The National Guidelines for Women's Health developed in 2002 by the Government with help from UNICEF to establish services friendly to women.

v. The National Strategic Framework and Plan for Vesico-Vaginal Fistula, developed by the Federal Government in 2005.

vi. The road map for accelerating achievement of the MDGs that cover maternal and newborn health, 2006. This set out priorities and strategies for reducing infant and maternal mortality.

vii. The Policy on the Health and Development of Adolescents and Young People in Nigeria, 2007. This aimed to reduce by 50% unwanted pregnancies and marriages among people younger than 18, and by 75% maternal mortality among young women.

viii. The National Health Bill, proposing the introduction of a National Health Insurance Scheme (decreed in 1999, implemented in 2005).

ix. An Integrated Maternal Newborn and Child Health Strategy, developed by the Ministry of Health in 2007. It sought to build synergy among the many programmes designed to reduce maternal, neonatal and child mortality in Nigeria.

The deadline is here; therefore, it is important to understand how the women in Nigeria perceive the actualization of the fifth MDG.

Theoretical Framework

This study was predicated on the schema theory. The theory was propounded by Robert Axelrod (1973). The schema theory assumes that most of our perceptions are put in context. A person tries to fit the information into the pattern which s/he has used it in the past to interpret

information about the same situation. Perception is usually based on past experiences. Humans usually want to compare a socio-political event with one that happened or was perceived in the past to see if there is a deviation or conformity. They tend to make their assessment of event using the schema of past event or using a schema of their expectation.

Based on the assumption of the schema theory, women in Nigeria would make their assessments of the progress made in actualization the fifth MDG based on any perceived improvement or extent of improvements on their past experiences. Their perceptions of the attainment of the 5th MDG are put in context. They try to compare and contrast the state of maternal health since 2000 up till now, and weigh how much have changed. Do they enjoy better maternal health now than ever before? Do they think the proportion of women dying in childbirth have reduced to the barest minimum? Is there any increase in the proportion of births attended by skilled health personnel? Do they have more access to reproductive health?

Method of study

The descriptive survey research method was adopted for this study. This was to determine the respondents' perception of the attainment of the 5th MDG (reduction of maternal mortality). Pregnant women registered in health facilities in Imo State, Nigeria, were purposively studied. 210 pregnant women were sampled in 21 (5%) out of the 416 documented health facilities in the State. Cooper and Schindler (2003) asserted that 5% of the population is ideal for a sample size, and anything that exceeds 5% may be reduced without sacrificing precision.

Area of Study

Imo State is one of the 36 states of Nigeria and lies in the south eastern region of the country with Owerri as its capital and largest city. Created in 1976, the state is named after the Imo River. The main cities in Imo State are Owerri, Orlu and Okigwe. The local language is Igbo and Christianity is the predominant religion. The State has a total population of 3,934,899. Imo State lies within latitudes 4°45'N and 7°15'N, and longitude 6°50'E and 7°25'E with an area of around 5,100 sq km. It is bordered by Abia State on the East, by the River Niger and Delta State on the west, by Anambra State to the north and Rivers State to the south.

Reliability of Research Instrument

The test-retest method of computing reliability using correlation coefficients was adopted in this study. In this method, the same people were measured at two different points in time, and a coefficient between the two scores was computed. The result of the pre-test using the Pearson Product

Moment Coefficient yielded a value of .75. This shows internal consistency of the content of the instrument.

Data Collection and Analysis

Data were gathered over a sampling period of 11 days by means of questionnaire. For clarity and understanding, the paper used tables to present its results. Out of the 210 copies of the questionnaire administered to pregnant women in the 21 health facilities in Imo State, Nigeria, only 202 copies were validly filled out.

Analysis of survey data

This section of the study contains the presentation and analysis of primary data collected from the pregnant women sampled in 21 health facilities in Imo State, Nigeria. The analysis of the primary data collected through the questionnaire was done using tables and sample percentages, while the information derived from in-depth interview was qualitatively analyzed and used to support the findings.

Table 1 addresses the educational distribution of the sampled pregnant women in Imo State.

Table 1: Educational Distribution of the Sampled Women

Qualification	Frequency	Percentage
Master Degree & above	28	14%
Bachelors / Higher National Diploma	69	34%
National Diploma	32	16%
Secondary School Cert. & below	73	36%
Total	202	100%

Table 1 shows that the bulk of the 202 sampled pregnant women, about 36% of the entire respondents, have secondary school certificate and below; this is followed by those with Bachelors/HND degree with a percentage proportion of 34%. Others include National Diploma holders (16%); and holders of Master's & higher degree (14%).

Table 2 addresses the perception of pregnant women in Imo State about the state of maternal health in Nigeria.

Table 2: Women's Perception of State of Maternal Health in Nigeria

Age Bracket	Frequency	Percentage
Under 20yrs	11	5%
21-30yrs	97	48%
31-40yrs	62	31%
Above 40yrs	32	16%
Total	202	100%

Table 2 shows that out of the 202 sampled pregnant women in Imo State, 11(5%) were under 20 years; 97(48%) were between 21 and 30 years; 62(31%) were between 31 and 40 years; and 32(16%) were above 40 years.

That is to say, majority of the sampled pregnant women were between 21 and 30 years; followed by those between 31 and 40 years.

Table 3 addresses the perception of pregnant women in Imo State about the state of maternal health in Nigeria.

Table 3: Women's Perception of State of Maternal Health in Nigeria

Option	Frequency	Percentage
Sound	88	44%
Poor	102	50%
Can't Say	12	6%
Total	202	100%

Table 3 shows that out of the 202 sampled pregnant women in Imo State, 88(44%) described the state of maternal health in Nigeria as sound; 102(50%) described the state of maternal health in Nigeria as poor, and 12(6%) could not describe the state of maternal health in Nigeria.

Table 4 addresses the views of pregnant women in Imo State about the extent of improvement, if any, in the state of maternal health in the country between 2000 and 2015.

Table 4: Extent of Perceived Improvement in the State of Maternal Health in the Country between 2000 and 2015

Option	Frequency	Percentage
Reasonable	6	3%
Average	22	11%
Low	166	82%
Never	8	4%
Total	202	100%

Table 4 above indicates that out of the 202 sampled pregnant women in Imo State, 6(3%) rated the improvement in the state of maternal health in the country between 2000 and 2015 as reasonable; 22(11%) rated the improvement in the state of maternal health in the country between 2000 and 2015 as average; 166(82%) rated the improvement in the state of maternal health in the country between 2000 and 2015 as low; while 8(4%) maintains that there has been no improvement in the state of maternal health in the country between 2000 and 2015.

Table 5 addresses the view of pregnant women in Imo State about the maternal health indicator that has experienced more improvement in the country between 2000 and 2015.

Table 5: Perceived Improvement in the Indicators of Goal 5

Option	Frequency	Percentage
Proportion of births attended by skilled health personnel	80	40%
Maternal mortality rate	122	60%
Total	202	100%

Table 5 above indicates that out of the 202 sampled pregnant women in Imo State, 80(40%) viewed proportion of births attended by skilled health personnel as the indicator that has received more improvement between 2000 and 2015; and 122(60%) viewed maternal mortality rate as the indicator that has received more improvement between 2000 and 2015.

Table 6 addresses the level of confidence reposed in the state of maternal health in Nigeria by pregnant women in Imo State.

Table 6: The Level of Faith Placed in Maternal Health Care in Nigeria

Option	Frequency	Percentage
Strong	52	26%
Tenuous	128	63%
No	22	11%
Total	202	100

Table 6 above shows the level of confidence reposed in the state of maternal health in the Nigeria by pregnant women in Imo State. Out of the 202 pregnant women sampled, 52(26%) described the level of confidence reposed in the state of maternal health in Nigeria as strong; 128 (63%) described the level of confidence reposed in the state of maternal health in Nigeria as tenuous; and 22(11%) had no confidence in the state of maternal health in the Nigeria.

Table 7 addresses the perception of pregnant women in Imo State regarding the factors that have affected the state of maternal health in the country between 2000 and 2015.

Table 7: Factors that affected Maternal Health in Nigeria between 2000 and 2015

Option	Frequency	Percentage
Socio-cultural/attitudinal issues	20	10%
Manpower issues	62	31%
Policy issues	6	3%
Infrastructure issues	22	11%
Accountability/transparency issues	92	45%
Total	202	100

Table 7 shows that out of the 202 pregnant women sampled, 20(10%) believed there were socio-cultural/attitudinal issues that have affected the state of maternal health in the country between 2000 and 2015; 62(31%) thought there were manpower issues that have affected the state of maternal health in the country between 2000 and 2015; 6(3%) indicated there were policy issues that have affected the state of maternal health in the country between 2000 and 2015; 22(11%) thought there were infrastructure issues that have affected the state of maternal health in the country between 2000 and 2015; and 92(46%) mentioned there were accountability/transparency issues that have affected the state of maternal health in the country between 2000 and 2015.

Discussion of major findings

In this section, major findings of this study as they relate to the research questions were discussed.

What is the perception of pregnant women in Imo State about the state of maternal health in Nigeria?

Analysis on Table 3 shows that 50% of the sampled pregnant women in Imo State described the state of maternal health in Nigeria as poor; 44% described the state of maternal health in Nigeria as sound; and only 6% could not describe the state of maternal health in Nigeria. There is only a marginal difference between the women who said the state of maternal health in Nigeria is poor and those who said it is sound. A simple majority of the sampled women think the state of maternal health in Nigeria is sound enough for them, but if you put their responses into perspective, in view of their subsequent responses, you would realize that they only perceive the state of maternal health in Nigeria to be sound because they have received what they considered good maternal care.

In a personal communication with some of the pregnant women, they acknowledged that the state of maternal health in Nigeria was “not-so-good, but not as poorly as it is reported.” According to them, there were a lot to be improved upon. The challenges faced with regard to maternal health in Nigeria include the disturbing rates of maternal death, deaths among teenage mothers and the use of unskilled birth attendants. The women also mentioned recurring stories of haemorrhage, eclampsia, sepsis and abortion complications among pregnant Nigerian women.

What is view of pregnant women in Imo State about the extent of improvement, if any, in the state of maternal health in the country between 2000 and 2015?

Analysis on Table 4 indicates that majority of sampled pregnant women (82%) in Imo State rated the improvement in the state of maternal health in the country between 2000 and 2015 as low; only 3% rated the improvement in the state of maternal health in the country between 2000 and 2015 as reasonable; 11% rated the improvement in the state of maternal health in the country between 2000 and 2015 as average; while 4% maintains that there has been no improvement in the state of maternal health in the country between 2000 and 2015.

In the areas where there are improvements, analysis on Table 5 indicates that 60% viewed maternal mortality rate as the indicator that has received more improvement between 2000 and 2015, and only 40% viewed proportion of births attended by skilled health personnel as the indicator that has received more improvement between 2000 and 2015.

The women's perception was supported by the MDG Report (2010) which states that maternal mortality in Nigeria fell by 32 per cent, from 800 deaths per 100,000 live births in 2003 to 545 deaths per 100,000 live births in 2008, but the proportion of births attended by a skilled health worker has remained low and threatens to hold back further progress.

What level of faith do pregnant women in Imo State place in the state of maternal health in Nigeria?

Analysis on Table 6 shows the level of confidence reposed in the state of maternal health in the Nigeria by pregnant women in Imo State. A majority of the sampled pregnant women (63%) described the level of confidence reposed in the state of maternal health in Nigeria as tenuous; only 26% described their level of confidence in the state of maternal health in Nigeria as strong; and 11% had no confidence, whatsoever, in the state of maternal health in the Nigeria.

Describing their confidence in the state of maternal health in Nigeria mostly as tenuous is an indication that the progress made so far in achieving the 5th MGD is less effective and not much progress is yet expected before the 2015 deadline draws to a close. The confidence in the health care system has not matched the numerous policies and strategies reportedly put together by the Government of Nigeria to meet acceptable standards in maternal health.

What do pregnant women in Imo State consider the factors that have affected the state of maternal health in the country between 2000 and 2015?

Analysis on Table 7 show that majority pregnant women (46%) sampled in Imo State thought that accountability/transparency issues have mostly affected the state of maternal health in the country between 2000 and 2015; 31% thought that manpower issues have rather affected the state of maternal health in the country between 2000 and 2015; 10% thought that socio-cultural/attitudinal issues have mostly affected the state of maternal health in the country between 2000 and 2015; 11% thought health infrastructure issues have mostly affected the state of maternal health in the country between 2000 and 2015; and 3% thought policy issues have affected the state of maternal health in the country between 2000 and 2015.

From the responses of the pregnant women sampled in Imo State, accountability/transparency issues ranks as the biggest issue that has affected the actualization of the 5th MDG in Nigeria, which is the improvement of maternal health by 2015. Other are manpower issues, socio-cultural/attitudinal issues, infrastructure issues, and to a negligible extent, policy issues.

Indeed, accountability/transparency issues are the biggest issue because the British Council (2012) lists 10 policies designed since 1999/2000 by the Federal Government of Nigeria to achieve the fifth MDG, some of which have been listed in this paper, yet the progress made in terms of achieving this goal is very low. Although several policies were instituted, such as the implementation of National Health Insurance Scheme (NHIS), Safe Motherhood Programme, development of National Vital Registration System and Making Pregnancy Safer Initiative, yet there are minimal impacts of these initiatives on maternal health. It all boils down to lack of sincerity, accountability and transparency of the Nigerian government in putting the policies or strategies into work and diligently pursuing their actualization. In short, Nigeria is a weak policy environment.

This does not discountenance the fact that the country is faced with other issues such as poor attitudes to antenatal and postnatal care and low quality of health care delivery as well as poor attitudes to reproductive health, poor state of the health infrastructure, inadequate skilled manpower in state hospitals and primary health centres, poor motivation system, inadequate funding, poor management of health sector resources, Doctors' and health workers' refusal of rural posting, etc.

Conclusion

The women's responses are indications that the progress made in Nigeria towards the attainment of the target of achieving maternal health is slow, as there are still many instances of deaths related to childbirth and patronage of unskilled birth attendants. Nigeria is moving forward in terms of reducing maternal mortality but the progress is very slow and attainment of the goal of reducing maternal mortality by two-third and improving maternal mortality by 2015 is unrealizable in Nigeria. The state of maternal health in Nigeria is "not-so-good." For this reason, the level of confidence reposed in the state of maternal health in Nigeria by Nigerian women is tenuous.

There are a lot of programmes and policies about maternal health in Nigeria, but progress, in terms of reducing maternal mortality but, as have been mentioned, is very slow; and this questions the sincerity, accountability and transparency of the government in implementing policy issues. Nigeria is therefore said to be a weak policy environment.

There is a general perception among the respondents that Nigeria has not reached the target and will not be able to actualize the goal by the end of 2015: while there is marked improvement, there is still no complete assurance among women of their safety during childbirth as women and children still die in the country daily before, during and after childbirth due to complications. Apart from the insincerity and lack of transparency and

political will to pursue health care reforms, other factors responsible for the slow progress are low ratio of births attended by skilled health workers, especially in rural areas; unfortunate attitudes to antenatal and postnatal care, poor state of health/medical infrastructure, poor motivation system, inadequate funding, poor management of health sector resources, weak transparency and accountability framework in the sector.

Recommendations

It therefore recommended that:

1. There is a need for Nigeria to declare primary health care as a national emergency in 2015 and implement those policies that will bring about structural change in the health sector and behavioural change among pregnant women. The country may have to extend that commitment to the newly declared Sustainable Development Goals (SDGs), and ensure that the proposed 17 goals with 169 targets of the SDGs are treated with more sincerity and commitment than the MDGs.
2. The cultural agencies should help to develop and apply behavioural change strategy on reproductive and basic health.
3. Issues that should be looked into include, improving the health infrastructure, training skilled manpower in state hospitals and primary health centres, developing sufficient motivation system, providing adequate health care funding and improving management of health sector resources.
4. As Odeh (2014) had recommended, the provision of reproductive health services to vulnerable populations should be made a priority. The government should ensure that health services are available to young married women, and those who cannot leave their homes. They should provide free, accessible and safe care during delivery.

References:

- Amnesty International, Nigeria (2006). *Rape: the silent weapon*, London, Zed Publishers.
- Axelrod, R. (1973). The schema theory. An information processing model of perception and cognition. *American Political Science Review*. LXVII: 1248-1266
- British Council Nigeria (2012). Improving the lives of girls and women in Nigeria Issues, Policies, Action (2nd Edition). Ukaid Department of International Development cooperative societies in *Bam Review of International cooperation*. Vol. 99. No. 1
- Chowwen, A., Orebiyi, O., Savadogo, A., Afere, T. and Afolayan, E. (2009). Achieving the millennium development goals: an assessment of water and sanitation intervention of the Ikaram millennium village, Nigeria. *Researcher*. 1(2):6-13

- Cooper, D.R., and Schindler, P.S. (2003). *Business research methods*. (8th ed.). Boston: McGraw-Hill Irwin.
- Federal Republic of Nigeria (2008). *Mid-point assessment of the millennium development goals in Nigeria (2000-2007)*.
- Federal Republic of Nigeria (2011). *Saving Newborn lives in Nigeria: Newborn health in the context of integrated Maternal, Newborn and Child Health Strategy (2nd Edition)*. Abuja: Ministry of Health.
- Federal Ministry of Health (2002): *Nigeria National Reproductive Health Strategic Framework and Plan, 2002- 2006*. Abuja: Federal Ministry of Health.
- Graber, D. (1988): *Processing the news: how people tame the information tide*. (2nd edn.) New York: Longman
- Igbuzor, I. (2011). *Overview of implementation of MDGs in Nigeria: Challenges and lessons*. A paper presented at the retreat organized by the Office of the Senior Special Assistant to the President on MDGs from 12-13th October, 2011 at Chida hotel, Abuja.
- Igbuzor, O (2006): 'The millennium development goals: can Nigeria meet the goals in 2015?' Paper Presented at a Symposium on Millennium Development Goals and Nigeria: Issues, Challenges and Prospects, organized by the Institute of Chartered Accountants of Nigeria (ICAN), Abuja District on 27 July, at Sheraton Hotel and Towers, Abuja
- Moser O.N. (1993). *Gender planning and development: theory, practice and training*. London: Routledge
- Odeh, Adiza M. (2014). The millennium development goals and women empowerment in Nigeria. *Public policy and administration research*. 4(7):130-140
- United Nations (2006). *Ending violence against women: from words to action*. New York.
- United Nations Department of Economic and Social Affairs (2004). Millennium Development Goals Report. <http://www.un.org/millenniumgoals/reports.shtml> Retrieved on July 4, 2015
- UNDP (2003). *Human development report 2003-millennium development goals: a compact among nations to end human poverty*. New York, Oxford University Press
- World Bank (2001), *World development report 2000/2001: Attacking Poverty*. N.Y., Oxford University Press Inc.
- World Bank (2003). *Africa and the World Bank: A Partnership for Development*, Washington DC\

IMPACT OF LEADERSHIP STYLES AMONG HEAD NURSES ON LEVEL OF JOB SATISFACTION AMONG STAFF NURSES

Ibrahim Mubarak Abdelhafiz

Medicine, University of Tabuk, Tabuk, Saudi Arabia

AlaDeen Mah'd Alloubani

Nursing, University of Tabuk, Tabuk, Saudi Arabia

Mahmmoud Klaledeh

Nursing, zarqa University, Amman, Jordan

Naif Mutari

Health Science, Alith University, Jeddah, Saudi Arabia

Mohammad Musa Almukhtar

Economics, Red Sea University, Port Sudan, Sudan

Abstract

Background: According to the studies made previously, it has been shown that the underlying basis of any communication between employees and leaders are the leadership styles. They also help improve the process of work in an organization.

Aim: The purpose of this study is to demonstrate the influence that leadership styles of different nurse leaders have on the satisfaction of work.

Methods: We selected three different private hospitals situated in Amman, and we had used descriptive and quantitative methods in the study.

Results: Among the participated hospitals, the highest score was gained by transformational leadership. The second highest was transactional leadership, followed by passive-avoidant. The job satisfaction level was seen to be quite high in this study. There was a positive relation between job satisfaction ($r=0.371^{**}$) and total score of transformational leadership (TRL). The transactional leadership score (TAL) also had a positive relation with respect to job satisfaction which was ($r=0.389^{**}$). However, the overall relationship between job satisfaction and passive-avoidant leadership (PAL) was seen to be negative in the result ($r=-0.241^{**}$).

Conclusion: It was concluded that a nurse's job satisfaction is increased by greater enhancement of transformational leadership attitude which further results in a greater nurse supply.

Keywords: Leadership styles, Job satisfaction, Nurse Leaders, Hospitals, Private Healthcare sector

Introduction

With respect to nurses, there has been a lot of study and investigation of job satisfaction in literature. There are various elements that are studied with respect to job satisfaction in nursing. According to studies made previously, there is an association between a nurse's job satisfaction and the leadership styles of the nurse acting as the head (Alloubani *et al.*, 2014). The way the head nurses present their leadership styles has a great influence on the job satisfaction among the nurses. To make sure that there are good nurses available, having nurses for a continued period of time is very important, which completely depends on the job satisfaction among nurses.

Since most of the nursing practice is carried out as group works, having a leadership is quite a natural factor in this profession (Huber, 2010). The more the leadership is effective, the better the level of satisfaction among nurses. This also influences the satisfaction levels among the patients, thereby improving the results of the organization (Schreuder *et al.*, 2011).

According to Marriner- Tomey (1993), there is no clarity among the leadership definitions, which is mainly the result of the terms used like management, administration, power, supervision and authority. As per Bass and Burn, (1985) and (1978) respectively, leadership is a process of transformation in which a leader develops a vision for the future with respect to the organization and he promotes and establishes different innovative ways for his followers and team members to work toward in order to achieve the goals. With respect to leadership, job satisfaction as a concept is not very plain. It has different conceptualizations. However, the most common definition in this regard is given by Porter *et al.* (1974) who believes that job satisfaction is the identification and its strength that a person achieves by being involved in some organization.

We carried out an investigation in the three hospitals, with respect to the differences in the styles of leadership and the ways these differences influenced job satisfaction. Moreover, we focused on creating a link between the predominant styles of leadership and job satisfaction in nursing shown by nurse managers. Furthermore, we can pin point the issues in hospitals by comparing the leadership styles and the influence of them on job satisfaction among nurses.

This study includes three major aspects which are: job satisfaction of the nurses, leadership styles and the context of the nurses. It also lays down the basis of this field in the future and with respect to the development in nursing leadership.

Methods

Design

The designs used in this study were cross-sectional, correlational, quantitative and descriptive. We used a technique of quantitative data collection to study the influence of leadership styles exhibited by the head nurses, on the job satisfaction. A correlational study can be defined as an efficient way to collect huge data with respect to particular elements (Polit and Beck, 2012). Descriptive or cross-sectional designs can affect the reasoning of a casualty (Germain and Cummings, 2010). Significantly, fifteen out of twenty-four papers that included studies about the factors influencing nursing leadership were classified as high and moderate in a quality review made previously. These papers made 63% of the total papers and they had used non-experimental, correlational and cross-sectional designs.

Instruments

One of the most commonly used methods to collect data is through questionnaires. They are effective methods to collect data regarding different client attributes. Questionnaires have been used to collect data about beliefs, behaviours, staff, knowledge, opinions, clients and perceptions (Parahoo, 2006). In this, we used two instruments namely: job satisfaction tool and Multifactor Leadership Questionnaire (MLQ) 5X short.

We first used the MLQ 5X short in this study (Bass and Avolio, 1995). There are two parts in this instrument: a rater form and a self-leader form. The former is used by the nurses in order to rate the head nurses, while the latter is used by the nurse managers to rate themselves. The present MLQ 5X is a short questionnaire having 45 items. In this questionnaire, five subscales are used for the measurement of the transformational leadership, while the transactional leadership is measured by two subscales. Other two subscales are to measure the passive-avoidant leadership/ laissez-faire. The rest of the subscales are for the results of the leadership (Bass and Avolio, 1995).

The MLQ is an efficient and an effective tool to measure different characteristics of leadership. It has alpha coefficients which are more than 0.80 for every scale of MLQ (Bass and Riggio, 2006). More than 30 countries have used MLQ and its different kinds in various aspects (McGuire and Kennerly, 2006). Moreover, MLQ has been used in multiple languages as well (Bass and Avolio, 1997).

This questionnaire for job satisfaction was designed by writers. The questionnaire had 17 different questions which made use of a 5-point Likert scale. The score of alpha was 0.82 with regard to the questionnaire's reliability.

Setting and Sampling

We selected three different privately owned hospitals situated in Amman. We had made our selection with respect to the obvious differences that prevailed at management levels. The names of these aforementioned hospitals were: Ibn Al-Hytham, Amman Hospital and Istishari Hospital. Our target population was the head nursing staff, while the working nurses of the hospitals were chosen for the study and were taken as a sample of the nurses.

These questionnaires were given at different shifts to the nurses and they were required to fill them and return to specified safe boxes in no more than five days. In order to increase the rate of response, we had kept these boxes in various admission offices of the hospital. In order to get the inclusion criteria assessed, we had approached the assistants and nurse managers. Given that these people were up to the criteria, we invited them to take part in this study by filling in the questionnaire. We had organized meetings with the directors of nursing in order to make sure that there was a good rate of return of the participants in the study as well as to ensure that the boxes were available to get the filled in questionnaires.

We calculated the sample size for the identification of the chief resulting variables that were measured, the measuring instrument of these variables and expected differences that the groups had (Gerrish and Lacey, 2010). Since it is quite common to practice in such a field, we had expected a medium effect size (Watson, 2008). The pre-set alpha level and the conventional power were at 0.5 and 0.80 respectively. We had used the t test to compare the project as the groups of the study did not have the nurses from the same medical stores. The size of the sample as per the parameters included 100 participants. However, it is believed that having a greater response of the survey would enhance the statistical efficiency. Out of 110 questionnaires, we received 100 responses which make a percentage of 90.9 (Table 1).

Dyera et al. and Baruch & Holtom, (2007) and (2008) respectively, believe that there should be a 75% rate of response at least. Having a greater rate of response means having greater samples of data and increased statistical efficiency.

Table 1 Sample distributions:

	Number of participants (Response rate)			Targeted sample		
	Staff	Manager	Combined Total	Staff	Manager	Combined Total
Hospitals	80 (80%)	20 (20%)	100 (90.9%)	84	26	110 (100%)
Total	80 (80%)	20 (20%)		84	26	

Ethical Approval

The central ethical committees of the relevant hospitals had given an ethical approval for our study. A sheet of information was given to every participant and it included the aim of the study, the rights that the participants had the process of the survey, the use of the data collected and the method of completing the given survey. Furthermore, it mentioned the fact that the information the participants would give in would be filled in anonymously and their data would be confidential. There were details of the contact given on the sheet in case there was any need of a query. It was made clear to the nurses that it was a voluntary kind of part they had to play, and they had every right to refuse any participation in it. Moreover, they were told that the results of the study would be generalized and no kind of identification of any participant could be seen through it.

Results

The purpose of the study was to see the way the leadership styles are interpreted by the nurse managers as well as the staff nurses. Another aim was to study the levels of job satisfaction found among the head nurses and the nurse staff. We investigated job satisfaction and leadership staff with respect to various variables. Moreover, the present study focused on determining if there is any sort of association between jobs satisfaction and leadership styles.

Participant Demographics: We collected data from 100 different participants. Out of these 100 participants, 20 of them were the nurse managers (20%), while the 80% of the remaining were the nurse staff. The female nurses were in majority (64%). 43% of these candidates were married people. Moreover, 78% of the managers and the staff were BSN educated while 48% of the people had experience of less than seven years. 56% of these participants were at or under the age of 30. The nurse managers were apparently older as compared to the staff nurses. Most of the managers were at or above the age of 40 (10/20). These managers had an experience of more than 18 years (3/20). Refer to table 2 for an illustrated demonstration of this data.

Table 2 Participants' demographics

Demographics	Staff Nurse (80)	Head Nurse Managers (20)	Total (Percentage)
Sample	80	20	100 (100%)
<i>Level of education</i>			
BSN	70	8	78 (78%)
MSN	10	12	22 (22%)
<i>Gender</i>			
Male	30	6	36 (36%)
Female	50	14	64 (64%)
<i>Age</i>			
30 or less	50	6	56 (56%)
30-40	22	4	26 (26%)
> 40	8	10	18 (18%)
<i>Marital status</i>			
Single	40	7	47 (47%)
Married	35	8	43 (43%)
Divorced	3	3	5 (5%)
Widowed	2	2	4 (4%)
<i>Length of experience</i>			
< 7 years	38	10	48 (48%)
7-12 years	12	3	15 (15%)
13-18	22	4	26 (26%)
> 18	8	3	11 (11%)

Perception of Leadership Styles in Two Medical Sectors

We had assessed various styles of leadership. This assessment comprised of staff nurses and head nurse managers. The highest score was seen to be with the head nurses who followed the transformational style of leadership. The second highest was by the transactional style of leadership and passive-avoidant leadership style (refer to table 3).

With respect to transformational leadership styles, the highest score was gained by inspirational motivation style of leadership, with considerable group means observed (refer to table 3). Likewise, the highest score was received by the contingent rewards style of leadership, having major differences with respect to means. Moreover, the lowest was received by the Laissez-faire (Table 3).

Table 3 Mean, SD. And P- Value for Leadership Styles.

Leadership Style	Mean	SD	T	P-value
Transformational Leadership	2.38	0.80	5.64	< 0.001
Idealized Influence (Attribute)	2.36	0.70	5.79	< 0.001
Idealized Influence (Behavior)	2.40	0.76	5.88	< 0.001
Inspirational Motivation	2.56	0.81	5.35	< 0.001
Intellectual Stimulation	2.30	0.99	5.11	< 0.001
Individualized Consideration	2.30	0.80	5.92	< 0.001
Transactional Leadership	2.35	0.88	4.45	< 0.001
Contingent reward	2.40	0.94	4.71	< 0.001
Active Management-by-Exception	2.30	0.80	4.12	< 0.001
Passive – avoidant leadership	1.27	0.84	2.12	0.03
Passive Management-by-Exception	1.32	0.87	2.35	0.70
Laissez-faire	1.22	0.82	1.57	0.01
(Score range: 0 not at all to 4 frequently if not always) / (Significant at < 0.05 level)				

Perception of Job Satisfaction in Private Sectors

With respect to the levels of job satisfaction, there was a major difference seen in the hospital staff that had participated ($M = 4.30$; $SD = 0.87$; $T = 6.47$, $P < 0.001$) (Table 4).

Table 4 Job satisfaction questionnaire in the private sectors

Group	Mean	SD	T	P
Job Satisfaction Questionnaire	4.30	0.87	6.47	<0.001

Relationship between Leadership Style and Job Satisfaction

In this section, we have given a review of the relations between job satisfaction and the various styles of leadership that prevail among the staff nurses and the nurse managers in Jordan. In table 5, a correlation matrix can be seen between the variables, with respect to a correlation of Pearson Product-Moment. We observed a positive relation between job satisfaction ($r = 0.371^{**}$) and transformational leadership score (TRL). Moreover, there was a positive correlation between all the transformational leadership and job satisfaction (refer to table 5).

There was positive correlation seen between the overall transactional leadership (TAL) and job satisfaction. It has been observed that there is a better relationship between job satisfaction and transactional leadership than job satisfaction and transformational leadership. Such a difference was also

seen in the relation between job satisfaction and the contingent reward leadership style ($r = 0.409^{**}$).

However, the overall correlations seen between job satisfaction and passive-avoidant style of leadership (PAL) was negative ($r = -0.241^{**}$). There was a negative relation between both the laissez-faire style of leadership and the passive management-by-exception and job satisfaction (Refer to table 5). Hence, major correlation was seen between jobs satisfaction and the various styles of leadership.

Table 5 Correlations between MLQ subscales and Job satisfaction using Pearson Product Moment.

Leadership Style	Job Satisfaction	P
Transformational Leadership (TRL)	0.371^{**}	<0.001
Idealized Influence – Attributes	0.271 ^{**}	<0.001
Idealized Influence – behavior	0.314 ^{**}	<0.001
Inspirational motivation.	0.387 ^{**}	<0.001
Individual consideration	0.341 ^{**}	<0.001
Intellectual stimulation	0.345 ^{**}	<0.001
Transactional Leadership (TAL)	0.391^{**}	<0.001
Contingent reward	0.409 ^{**}	<0.001
Management-by exception- active	0.228 ^{**}	<0.001
Passive/Avoidant leadership (PAL)	-0.241^{**}	<0.001
Management-by-exception-passive	-0.210 ^{**}	<0.001
Laissez-faire.	-0.225 ^{**}	<0.001
** Correlation is significant at the 0.01 level (2-tailed)		
* Correlation is significant at the 0.05 level (2-tailed)		

Discussion

The purpose of this study was to comprehend how the leadership styles were interpreted by the staff managers in Jordan. According to the MLQ results, these staff nurses had taken their managers as transactional as well as transformational leaders simultaneously. According to the 20 participating managers, they said to be using the five leadership styles of transformation and using the two transactional sub-styles. This result is also supported by Bass that both kind of leadership styles can be exhibited by the leaders simultaneously (Bass, 2008).

According to Bass and Riggio (2006), there is a positive relation between the satisfaction levels among employees and the styles of leadership (transactional and transformational). Although according to the groups, there was a use of both leadership styles by the nurse managers, the staff believed that there was a greater use of transactional and transformational styles of leadership by the managers than by the nurse managers. Failla & Stichler (2008) as well as Omar (2006) concur with such a finding.

According to this study, the staff nurses believed that their nurse managers used transactional leadership quite often than sometimes. The

highest score was received by the contingent reward sub-style, which shows that significant rewards are given by the leaders on the fulfilment of tasks. According to a recent study, transformational dimension and the contingent reward sub-style have similar characteristics (Andrews et al. 2012).

There was a difference of 0.56 ($P < 0.001$) between the mean in the managers' style of leadership perception and the mean gained. This was with respect to the observation made in the transactional subscale (contingent reward). Contingent reward can be defined as a style where an agreement is obtained by the leader on different tasks that are to be fulfilled, and in return the leader gives rewards at the completion of the tasks. There is a difference between the private hospitals and the government hospitals on the basis of salary, promotions, etc. This shows that there are better results in hospitals that are financially supported (El Amouri, 2010).

The highest score was received by the transformational style of leadership and the second highest was by the transactional style and passive-avoidance.

According to Avolio and Bass (2004), an inspirational leader is a leader who promoted encouragement and inspiration among the followers by inculcating a meaning in the assigned work.

Job satisfaction is a very important issue for an organization with respect to various factors especially the ones related to health care system. Following parameters were measured through the job satisfaction questionnaire: the belief of the participant in the values and missions of the organization; willingness to stay in the hospital in the future; and willingness to input greater efforts toward the success of the hospital. According to the mean score in the present study, there was quite a high level of job satisfaction among the participants. However, this result is quite contrasting with the previous one where the job satisfaction levels among Iranian nurses were low (Vanakai & Vagharseyyedin, 2009).

According to an earlier study made in Saudi Arabia, there were low levels of job satisfaction among the nurses and these people were willing to switch jobs if given an opportunity (Al-Aameri, 2000).

With respect to job satisfaction, there was a high exhibition by the private nurses as suggested by the mean scores (4.85). Apart from the difference in the styles of leadership, higher levels of job satisfaction can also be reasoned by the flexibility in the personnel system in the hospitals where nurse managers are allowed to carry out promotions among the nurse staff. Such hospitals facilitate nurse staff with entertainment opportunities and recreational activities during the time of leisure.

As per the study results, there was a correlation between job satisfaction and all the MLQ subscales. There was a correlation between the transformational leadership and job satisfaction. There was a positive

relation between levels of job satisfaction among the staff nurses and a transformational leader. The results show that a presence of a manager displaying transformational attributes results in better satisfied staff at the hospital.

The findings of Leach (2005) are supported by the overall result. According to Leach, transformational leadership shows a positive effect on the job satisfaction levels among the nursing staff. Moreover, this result is supported by Laschinger *et al.* (2009) who demonstrated that there is an influence of leadership styles on every nurse and her level of job satisfaction. There is a direct and a positive link between job satisfaction level and transformational leadership. These factors play a direct effect on the outcome of a patient (Casida and Parker, 2011; Alloubani *et al.* 2015).

According to this result, transformational leaders who showed characteristics of motivational leaders led to better and more satisfied nurses. As per the results, the correlation between jobs satisfaction and transformational leadership subscale was the most important relation seen among all the discussed subscales of transformational leadership ($r = 0.387^{**}$, $P < 0.001$).

Inspirational motivation is when there is a leader who develops and promotes a vision and a team spirit among the employees. This is also supported by the Multifactor Leadership Model according to which followers are more inclined toward leaders who show natural enthusiasm and optimism (Bass, 1998). Furthermore, according to Bass and Riggio (2006), we can build job satisfaction through a style of leadership which exhibits motivation and inspiration. An inspirational leader is dedicated to drive followers to take moral values into consideration as their duties toward the organization and profession.

Job satisfaction can be affected by a transformational style of leadership. A recent study on the correlations existing between the results and the nurse managers' leadership styles showed that efficient nursing leaders who show transformational leadership characteristics improved the levels of job satisfaction (Casida and Parker, 2011).

Moreover, there was a positive relation between jobs satisfaction among the nurses and transactional leadership having management by-exception and contingent reward nurses ($r = 0.391^{**}$, $p < 0.001$). There was a higher score by contingent reward as compared to management-by-exception (active). Contingent reward also enhanced the satisfaction score (overall) of the transactional style. Similar result is found by McGuire *et al.* (2003) as well as by Windsor (2009) who showed that there was little satisfaction shown by nurses under the management-by-exception (active). However, there was a better satisfaction level with contingent reward leadership.

As per the Multifactor Leadership Model, contingent reward is possible when there are goals and directions set by a leader who is determined to withhold appreciation rewards like bonus and recognition in order to have control over the tasks. According to Marquis and Huston (2008), leadership styles are developed through different beliefs, values and leader choices as well as the culture and environment of an organization that may or may not support different styles of leadership. As per McGuire & Kennerly (2006), rewards and recognition is seen as a source of retention for the nurses by organizations.

There was a negative relation seen between job satisfaction and passive-avoidant leadership ($r = -0.24^{**}$, $P < 0.001$). This shows that leaders having greater characteristics of passive-avoidant had nurses with little satisfaction. The Multifactor Leadership Model also showed similar findings where leaders with passive-avoidant are unable to promote loyalty, thereby creating negative followers of the staff (Bass & Avolio, 2000).

Moreover, such results were shown in a study that showed the relations between job satisfaction levels and leadership styles of nursing. This study was based on nurses in America. There was a negative correlation seen between job satisfaction and laissez-faire style of leadership (Windsor, 2009).

Suliman (2009) also showed similar finding where nurse managers believed not to be using a passive-avoidant leadership. However, this finding was not so strong by Omar (2006).

According to the nursing staff, the nurse managers' style of passive-avoidant leadership was seen as *once in a while to seldom*. Passive management-by-exception that showed highest score of mean describes leaders as those who take action only after they are in a serious state of mind. Moreover, Suliman (2009) has a similar result. Leaders who are passive-avoidant tend to be little or no responsive and are no source of motivation or inspiration for the followers.

Jobs satisfaction is believed to be a huge predictor with respect to the turnover behaviour of staff (Wagner, 2007). According to an Arabian study made recently on nurses who were not sure about their job, showed that there is a huge influence of leadership style on job satisfaction (Abualrub and AlGhamdi, 2012). Serious measures should be taken for the development of efficient leadership in the hospital system of Jordan.

Conclusion

Understanding the relation between job satisfaction and leadership is very important. According to what we believe, the nursing educators, policy makers and the administrators will find this study beneficial and it will help them overcome the problems and challenges they come across every day.

There is very little study and research with respect to jobs satisfaction and leadership in the health care system of the non-West culture and this study has contributed to it.

Various areas have been revealed by the study which needs further study and research. The efforts of research should be focused toward the examination of the work factors and the environmental issues that affect job satisfaction. In conclusion, according to this study results, greater transformational leadership development enhances the job satisfaction levels which further add to the contribution of a greater supply of nurses.

References:

- Abualrub, R. & AlGhamdi, M. (2012). The impact of leadership styles on nurses' satisfaction and intention to stay among Saudi nurses. *Journal of Nursing Management*, 20, 668–678.
- Al-Aameri, A. (2000). Job satisfaction and organizational commitment for nurses *Saudi Medical Journal*, 21(6) 531-535.
- Alloubani, A.M., Almatari, M. & Almukhtar, M. (2014). Review: Effects of Leadership Styles on Quality of Services in Healthcare. *European Scientific Journal* 10(18),118-129.
- Alloubani, A., Abdelhafiz, I. M., Abughalyun, Y., Edris, E. E. M., & Almukhtar, M. M. (2015). Impact of Leadership Styles on Leadership outcome (Effectiveness, Satisfaction and Extra Effort) in the Private Healthcare Sector in Jordan. *European Scientific Journal*, 11(10).
- Andrews, D. R., Richard, D. C. S., Robinson, P., Celano, P. & Hallaron, J. (2012). The influence of staff nurse perception of leadership style on satisfaction with leadership: A cross-sectional survey of pediatric nurses. *International Journal of Nursing Studies*, 49, 1103-1111.
- Avolio, B. & Bass, B. (2004). Multifactor Leadership Questionnaire, Manual and Sampler Set. Third Edition ed. Redwood City, CA: Mind Garden.
- Baruch, Y. & Holtom, B. (2008). Survey response rate levels and trends in organizational research. *Human Relations*, 61, 1139-1160.
- Bass, B.M. (1985). Leadership and performance beyond expectations: Free Press New York.
- Bass B.M. (1998). Transformational leadership: Industrial, military, and educational impact: Lawrence Erlbaum.
- Bass, B.M. (2008). handbook of leadership: Theory, research & managerial applications. 4 ed: New York: Free Press.
- Bass, B. M. & Avolio, B. J. (1995). *The Multifactor Leadership Questionnaire – 5x Short Form*, Redwood: Mind Garden.
- Bass, B. M. & Avolio, B. J. (1997). *Revised manual for the Multifactor Leadership Questionnaire*, Palo Alto, CA, Mind Garden.

- Bass, B. M. & Avolio, B. J. (2000). Effects on platoon readiness of transformational / transactional platoon leadership. Final Report. (Contract DASW01-96K-0008, U.S.: Army Study Institute for the Behavioral and Social Sciences.
- Bass B. and Riggio R. (2006). Transformational Leadership 2nd ed. New Jersey: Lawrence Erlbaum Associates.
- Burns, J. M. (1978). Leadership. New York: Harper & Row.
- Casida, J. & Parker, J. (2011). Staff nurse perceptions of nurse manager leadership styles and outcomes. *Journal of Nursing Management*, 19, 478–486.
- Dyera, P., Gursoyb, D., Sharmaa, B. & Carter, J. (2007). Structural modeling of resident perceptions of tourism and associated development on the Sunshine Coast, Australia. *Tourism Management*, 28, 409–422.
- El Amouri, S. (2010). The leadership style of nurse leader managers in United Arab Emirates (UAE) hospitals that facilitates culturally competent care. University of Southern Queensland. Doctoral Dissertation.
- Failla, K. & Stichler, J. (2008). Manager and Staff Perceptions of the Manager's Leadership Style. *The Journal of Nursing Administration*, 38, 480-487.
- Germain, P. B. & Cummings, G. G. (2010). The influence of nursing leadership on nurse performance: a systematic literature review. *Journal of Nursing Management*, 18, 425-439.
- Gerrish, K. & Lacey, A. (2010). *The Research Process in Nursing*, (6th Edition)Oxford: Wiley-Blackwell.
- Huber, D. (2010). Leadership and nursing care management 2nd edition, Pennsylvania: W. B. Saunders.
- Laschinger, H., Finegan, J. & Wilk, P. (2009). The Impact of Unit Leadership and Empowerment on Nurses' Organizational Commitment. *the journal of Nursing Administration*, 39, 228-235.
- Leach, L. (2005). Nurse Executive Transformational Leadership and Organizational Commitment. *Journal of Nursing Administration*, 35, 228-237.
- Marriner-Tomey, A. (1993). Transformational leadership in nursing, St. Louis, MO, Mosby-Year Book.
- McGuire, M., Houser, J., Jarrar, T., Moy, W. & Wall, M. (2003). Retention: It's All About Respect. *The Health Care Manager*, 22, 38-44.
- McGuire, E. & Kennerly, S. (2006). Nurse managers as transformational and transactional leaders. *Nursing Economics*, 24(4), 179-185.
- Parahoo K. (2006). *Nursing Research Principles, Process and Issues*, 2nd edn. Palgrave Macmillan, Hampshire.

- Polit, D. F. & Beck, C. T. (2012). *Nursing Research: Generating and Assessing Evidence for Nursing Practice* (9th Ed). Philadelphia: Lippincott Williams and Wilkins.
- Porter, L.W.; Steers, R.M.; Mowday, R.T. & Boulian, P.V. (1974). Organizational commitment, job satisfaction and turnover among psychiatric technicians. *Journal of Applied Psychology*, 59(5), 603–609.
- Schreuder, J., Roelen, C., Zweeden, N., jongsma, D., klink, J. & Groothoff, J. (2011). Leadership effectiveness and recorded sickness absence among nursing staff: a cross-sectional pilot study. *Journal of Nursing Management*, 19(5), 585-595.
- Suliman, W.A. (2009). Leadership Styles of Nurse Managers in a Multinational Environment. *Nurse Administration Quarterly*. Vol. 33, No. 4, pp. 301–309
- Squires, M., Tourangeau, A., Laschinger, H. & Doran, D. (2010). The link between leadership and safety outcomes in hospitals. *Journal of Nursing Management*, 18, 914–925
- Wagner, C. (2007). Organizational commitment as a predictor variable in nursing turnover research: literature review. *Journal of Advanced Nursing*, 60, 13.
- Watson, R., McKenna, H., Cowman, S. & Keady, J. (Eds) (2008). *Nursing Research: Designs and Methods*, Edinburgh, Churchill Livingstone Elsevier.
- Windsor, K. (2009). Correlation of nurse leadership style to organizational commitment of foreign-educated nurses in U.S. Hospitals [D.H.A Dissertation] United States, Arizona: University of Phonics.
- Vanaki, Z. & Vagharseyyedin, S. A. (2009). Organizational commitment, work environment conditions, and life satisfaction among Iranian nurses. *Nursing & Health Sciences*, 11, 404-409.

CHEMICAL COMPOSITIONS, ANTIOXIDANT CAPACITY OF TIGERNUT (*Cyperus esculentus*) AND POTENTIAL HEALTH BENEFITS

Ogunlade, I., PhD
Adeyemi Bilikis, A., B.Sc
Aluko Olanrewaju, G., B.Sc.

Department of Chemistry, Department of Science Laboratory Technology
Ekiti State University, Ado-Ekiti, Ekiti State, Nigeria

Abstract

Tiger nut (*Cyperus esculentus L.*) considered as an intrusive weed in most countries but taken as snack in Nigeria was analyzed for proximate and mineral compositions using standard analytical techniques. Antioxidant activity of the methanolic extract was measured using 2, 2-diphenyl-1-picrylhydrazyl (DPPH), while the total phenolic content was determined according to Folin-Ciocalteu method. The results revealed that the three forms of the tuber (dry, raw and roasted) as consumed had % moisture ranging from (12.57-43.84); protein (1.32-2.24); fat (1.44-1.54); ash (3.34-6.69); crude fibre (16.14-17.14); and carbohydrate (30.58-62.79). The samples were significantly high in Na, K and Ca. Na-K ratio was also found to be less than 1 suggesting its suitability in formulating diets for hypertensive patients. Antioxidant activity of the samples ranged from 3.72-5.90; 5.22-9.72; 11.63-16.10; and 15.95-23.00 % inhibitions at different levels of concentrations while total phenolic content ranged from (806.7-1150.7) micromole GAE/g. The results indicate that the edible tubers which are used for non-alcoholic local beverage formulation, in medicine and cosmetic industry can be utilized to 'mop up' and scavenge free-radicals generated by essential metabolic body reactions and environmental pollutants. It is hoped that addition of tiger nut as side dish and adjunct in traditional diets will probably alleviate the symptoms associated with neurodegenerative and cardiovascular diseases.

Keywords: Tiger nuts, Antioxidant capacity, Free radicals and Diseases

Introduction

The existence of large population and biodiversity of food plant species has continued to play a prominent role in ensuring healthy lives and promoting well-being for all at all ages. This becomes imperative with increase in population, growing environmental population and its resultant health hazards.

One of such plant is Tigernut (*Cyperus esculentus L.*) an annual or perennial plant called chufa sedge, nut grass, a mildly poisonous crop of the sedge family. It is found wild as a weed (Sánchez-Zapata, *et al*, 2012) or as a crop often cultivated for its edible tubers in many countries including Nigeria.

Tigernut, a tuber with sweet and nutty taste can be consumed raw, roasted, dried or as tigernut milk or oil (Rita, 2009). It can be stored and rehydrated by soaking without losing the crop texture which ensures acceptable sensory quality (Tucson & Arizona, 2003)

Tigernut is sometimes added to biscuits and other baking products, as well as in making oil, soap and starch extracts (Cantalejo, 1997). It is reported to be in use in medicine and cosmetic industry (Defelice, 2002) as an animal feed and eaten raw as a side dish (Omode *et al*, 1995;).

It is also used for the production of nougat, jam, beer and as a flavouring agent in ice cream (Cantalejo, 1997) and in the preparation of Kunnu Aya (a non-alcoholic local beverage in Nigeria. (Belewu & Abodunrin, 2008).

Literature values revealed that tigernut helps to prevent heart problems, thrombosis and activate blood circulation; it is also responsible for preventing and treating urinary tract and bacterial infection and assist in reducing the risk of colon cancer when eaten. (Adejuyitan *et al*. 2009).

The local non-alcoholic drink has it's advantage of no containing sodium, lactose sugar, casein protein, gluten, cholesterol and therefore suitable as beverage for diabetics or do not tolerate gluten or lactose and its derivatives present in cow milk (Belewu & Abodunrin, 2006).It is at the backdrop of the information on the potentials of this edible tuber in chemical, pharmaceutical and food industries that this present work, analytical evaluation and antioxidant capacity of the various forms (raw, dry & roasted) of tigernut often consumed as snack, side dish and drink formulation in Nigeria is undertaken.

Materials and methods

Collection of the samples

Tigernut tubers were bought from a local market Ado-Ekiti, Ekiti State, Nigeria.

Preparation of the Sample

The tigernut tubers were properly screened to remove the defective ones. Raw tigernut tubers were divided into three parts. One part was air dried; the second part was roasted for 20 minutes while the third sample was left as raw. The three samples were blended with an electric blender separately.

Extraction of the samples

10g of each of the sample were weighed and dissolved in methanol for extraction.

Proximate analyses

The proximate analyses were carried out according to the method of AOAC, 1990. The result of the proximate analyses was determined in %.

Mineral analyses

Atomic absorption spectrophotometer (Perkin-Elmer Model, Norwalk CT) was used to determine Ca, Fe, Cu, and Mn. Na and K was evaluated using Flame photometer (FP. Model 140).

Antioxidant activity (AA)

The antioxidant activity of the samples were analyzed using DPPH method (2, 2-diphenyl-1-picrylhydrazyl) free radical by Huang *et al*, 2005. 3ml of the filtrates of each of the samples dissolved in methanol was mixed with 0.5ml of DPPH reagent. The absorbances of the samples at different concentrations were read at 517nm and the percentage inhibitions were calculated against the control.

Total phenolic content (TPC)

The total phenolic content of the samples were determined using Folin-Ciocalteu method (Singleton *et al*, 2006). The absorbances of the extracts were determined at 750nm after 30minutes. The results were expressed as micromole GAE/100g.

Results and discussion

The results of the proximate and mineral compositions of the various forms of tigernut tubers were presented in table 1.

Table 1: Proximate and Mineral Compositions of Tigernut tubers

Components	Sample A	Sample B	Sample C
Proximate composition (%)			
Moisture content	12.27 (0.02)	43.84 (0.02)	24.96 (0.06)
Crude protein	1.56 (0.02)	1.32 (0.01)	2.24 (0.01)
Fat	1.49 (0.01)	1.44 (0.01)	1.54 (0.01)
Ash	5.64 (0.02)	6.69 (0.01)	3.34 (0.04)
Crude fibre	16.26 (0.01)	16.14 (0.01)	17.14 (0.01)
Carbohydrate	62.79 (0.03)	30.58 (0.02)	50.82 (0.01)
Metabolisable energy (KJ/100g)	1149.08	595.88	959.00
Mineral compositions (mg/100)			
Na	101.17	101.30	111.10
K	122.90	122.40	123.60
Ca	91.60	83.00	93.40
Fe	3.80	3.60	4.20
Mn	0.40	0.20	0.50
Cu	0.30	0.20	0.60
Na/K	0.82	0.83	0.90

LEGEND

(±) SD = Standard deviation in parenthesis

SAMPLE A = Dry Tigernut tubers

SAMPLE B = Raw Tigernut tubers

SAMPLE C = Roasted Tigernut tubers

Higher results were observed in moisture content; ash; and crude fibre when compared with the literature (Aremu *et al*, 2015; Oladele and Aina, 2007). The higher significance observed in this present result occurred because the samples were oven dry at 20⁰C when compared with those samples in the literature. In addition, the values observed in crude protein, fat, and metabolisable energy were found to be lower when compared with those reported on tigernut by Gambo and Da'u, 2014 which would probably be due to difference in variety.

Essential minerals such as Na, Ca, K are found to be comparable with the results in the literature. (Olade and Aina, 2007) Na-K ratio was found to be less than 1 in all the samples suggesting that tigernut tubers will probably be suitable for food formulation of diets for hypertensive patients (Ogunlade, 2005).

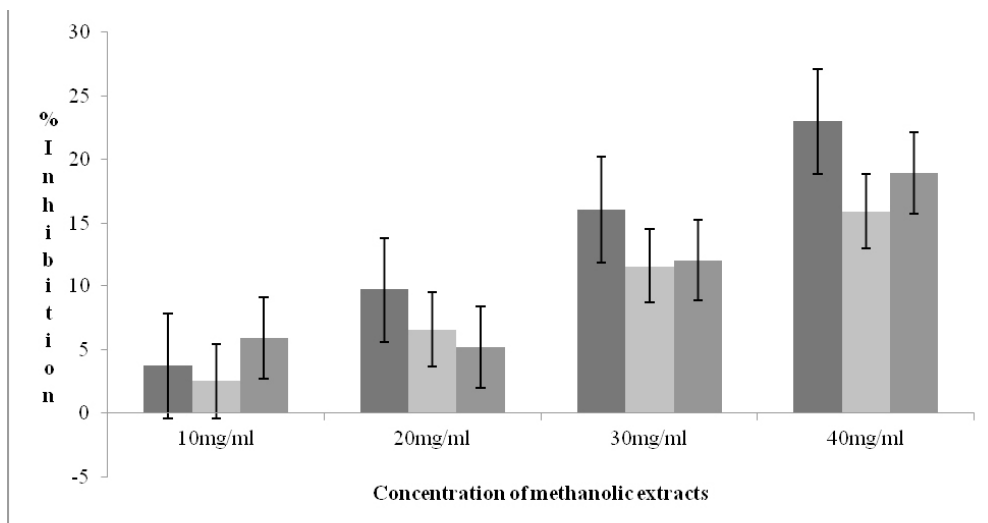

Figure 1: % Inhibition of the Antioxidant Activity of Tigernut tubers

The results of the % inhibitions of the antioxidant activity of the samples at different concentrations were presented in Figure 1 with roasted tigernut significantly higher in antioxidant activity.

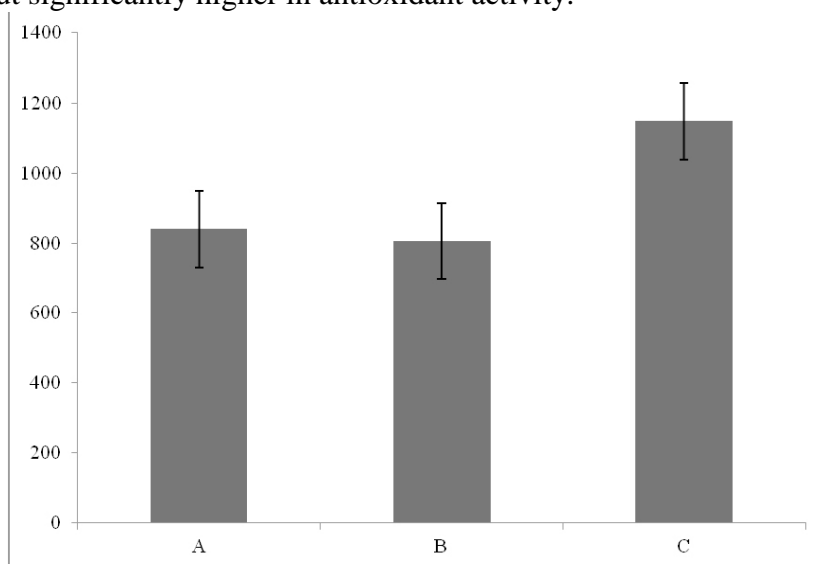

Figure 2: Total Phenolic Content of Tigernut (micromoleGAE/g)

LEGEND

- (±) SD = Standard deviation in parenthesis
- SAMPLE A = Dry Tigernut tubers
- SAMPLE B = Raw Tigernut tubers
- SAMPLE C = Roasted Tigernut tubers

Figure 2 showed the result of the total phenolic content of the sample. Roasted tigernut was found to be significantly higher. The result obtained in this work are favourably compared with those reported for other commonly consumed nuts and fruits (Ogunlade *et al*; 2011 and Ogunlade *et al*, 2012.).

Figure 1 and 2 indicate that all the forms of tigernut contain phytochemical substances which are responsible for high antioxidant capacity.

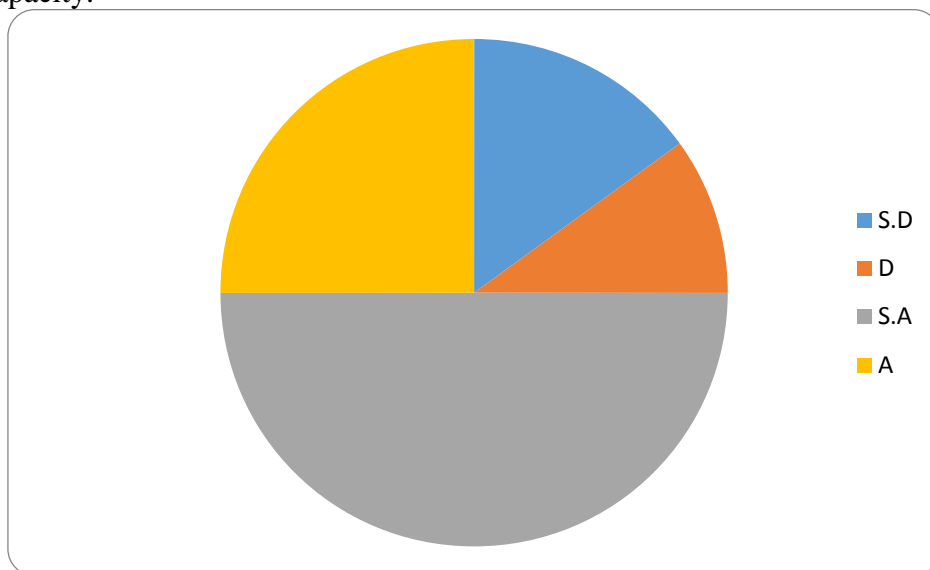

Figure 3: Pie chart representation for the result of the consumption pattern observed from the questionnaire administered.

A survey conducted on the consumption pattern of the various forms of consumed in southwest of Nigeria as shown in fig. 3, revealed that 50% of the correspondents eat the raw tigernut tubers as snack food, while 25% prefer the dry form. 15% only took it based on the fibre content which is said to aid digestion (Abaejoh *et al*, 2006) while 10% preferred roasted form which is scarcely found in market.

Conclusion

Tigernut has been grossly underutilized and unexploited despite its potentials, which is due to paucity of information and lack of awareness of the composition. The results showed that tiger nut can be a valuable source of nutrients and phytochemicals as it favorably compared with the proximate and mineral composition of some other edible nuts and tubers. It is hoped that utilization of tigernut in diets will probably help to ‘mop-up’ the free radicals and lower the incidence of cardiovascular and other age-related disorder diseases.

References:

- Abaejoh, R., Djomdi, I. and Ndojouenkeu, R. (2006). Characteristics of tigernut (*Cyperus esculentus*) tubers and their performance in the production of a milky drink. *J. Food Process Preservatives*, 30: 145-163
- Adejuyitan, J.A., Otunola E.T., Akande. E.A., Bolarinwa. I.F. and Oladokun, F.M. (2009). Some Physicochemical properties of Flour obtained from fermentation of tiger nut (*Cyperus esculentus*) sourced from a market in Ogbomoso, Nigeria. *African Journal of Food Science*, 3: 51-55.
- AOAC, (1990) Official methods of analysis 15th ed. Washington: Association of Official Analytical Chemist.
- Aremu, M. O; Bamidele, T. O. Agere H., Ibrahim H. and Aremu, S. O. (2015). Proximate Composition and Amino Acid Profile of Raw and Cooked Black Variety of Tiger nut (*Cyperus esculentus* L.) Grown in Northeast Nigeria. *Journal of Biology, Agriculture and Healthcare*. ISSN 2224-3208 (Paper) ISSN 2225-093X (Online) Vol.5, No.7.
- Belewu, M.A; Abodunrin, O.A (2008). "Preparation of Kunnu from Unexploited Rich Food Source: Tiger Nut (*Cyperus esculentus*)". *Pakistan Journal of Nutrition* 7: 109-111. doi:10.3923/pjn.2008.109.111.
- Belewu M. A, and Abodunrin A. O.(2006). Preparation of kunnu from unexploited rich food source: Tigernut (*Cyperus esculentus*). *World Journal of Dairy and Food Sciences*. 1: 19-21.
- Cantalejo, M.J. (1997). Analysis of volatile components derived from raw and roasted earth –almond (*Cyperus esculentus* L.). *J. Agric. Food Chem.* 45: 1853 – 1860.
- Defelice, M.S (2002). "Yellow Nutsedge *Cyperus esculentus* L.—Snack Food of the Gods!". *Weed Technology* 16: 901–7. doi:10.1614/0890-037x(2002)016[0901:yncels] 2.0.co;2.
- Gambo, A. and Da'u, A. (2014). Tiger nut (*Cyperus esculentus*): composition, products, uses and health benefits – a review. *Baryero Journal of Pure and Applied Science*. 7(1): 56-61. Ba j o p a s V o l u m e 7 N u m b e r 1
- Ogunlade, I; O. Olaofe and T. Fadare (2005). Chemical composition, amino acids and functional properties of some selected seafoods. *J. Fd. Agriculture and Environment*. Vol 3 (2): 130–133.
- Ogunlade, I; A. Oni and A.I. Osasona (2011). Comparative analysis of antioxidant capacity and total phenolic content of some selected fruits in Ekiti State, Nigeria. *NISEB Journal* 11,4,329-334.
- Oladele, A.K., and Aina, J.O. (2007). Chemical composition and Functional properties of Flour produced from two varieties of tiger nut. *African Journal of Biotechnology*, 6: 2473- 2476.

- Omode A. A, Fatoki O. S, and olaogun K. A (1995). Physicochemical properties of some underexploit and nonconventional oilseeds. *J. Agric Food Chem* **43**: 2850-3. CrossRef, CAS, Web of Science. Times Cited: 23
- Rita E.S (2009). The use of tiger-nut (*Cyperus esculentus*), cow milk and their composite as substrates for yoghurt production. *Pak. J. Nutr.*; **6**: 755758.
- Sánchez-Zapata, Juana Fernández-López and José Angel Pérez-Alvarez (2012). Tiger Nut (*Cyperus esculentus*) Commercialization: Health Aspects, Composition, Properties, and Food Applications. Article first published online: 12 JUN 2012 DOI: 10.1111/j.1541-4337.2012.00190.x © 2012 Institute of Food Technologists®
- Singleton, V., R., Orthefer, R., Lamela-Raventos, R, M., 1999. Analysis of total phenols and opher oxidation substrates and antioxidants by means of Folin-Coicaltea reagent.Method is Ennymology. 299, pp 152-178.
- Temple VJ, Ojebe TO, Kapu MM. 1989. Chemical analysis of tiger nut (*Cyperus esculentis*). *J Sci Food Agric* **49**:261–2.
- Tucson & Arizona (2003). USGS Weeds in the West project: Status of introduced Plants in Southern Arizona Parks, Factsheets for *Cyperus esculentus L.*

REGIONAL WATER USE PRACTICES IN THE KWAHU EAST DISTRICT OF GHANA AND THE POTENTIAL INFLUENCE ON DIARRHEAL DISEASE

Deborah Lardner, D.O., D.T.M&H

Michael Passafaro, D.O., D.T.M&H

New York Institute of Technology College of Osteopathic Medicine,
United States

Kristin F. Gotimer, D.O., M.P.H.

Winthrop Hospital, United States

David Guernsey, M.P.H.

New York Institute of Technology College of Osteopathic Medicine,
United States

Christina Padgett, D.O.

State University of New York at Buffalo, United States

Sriniketh Sundar, D.O.

St. Luke's/Roosevelt Hospital, United States

Abstract

Background: In low income countries, the Daily Adjusted Life Years (DALYs) of unsafe water, sanitation, and hygiene is 530/100,000 and is the 6th leading cause of death in children. Ghana, located in West Africa, is greatly impacted by poor sanitation and unsafe water supply. The objective of this study is to assess local water use and sanitation practices in the Kwahu East district of Ghana and how they relate to diarrheal disease.

Methods: A cross-sectional survey was administered to 236 households in the Kwahu East district. It was divided into four sections: demographics, water use practices, water related illness, and water related sanitation. Prevalence data for certain variables were calculated and simple t-tests compared difference in water practices for different demographic groups based on gender, age, and education status.

Results: Surface water and pump-well/borehole were the main sources of water for this area. Household demographics played a role in determining the household water collector. Over 95% of the responders did not treat their water. Moreover, gender, education, and age played significant roles in the degree of knowledge about diarrheal disease.

Conclusions: Gender, education, age, and household size are all key factors that impact water practices. The results of this study can be used for the development of culturally sustainable interventions directed towards the improvement of access to safe drinking water, and in turn, reduce waterborne illness.

Keywords: Ghana, water use practices, waterborne disease, diarrheal disease, sanitation hygiene

Introduction

It has been estimated that 663 million people worldwide still lack access to clean, reliable water sources, with the majority located in Sub-Saharan Africa. In low-income countries, unsafe water, sanitation, and hygiene is the 4th leading cause of death overall, and the DALYs of unsafe water, sanitation, and hygiene for low-income countries is 530/100,000 (World Health Organization [WHO], 2009). In rural communities, it is estimated that eight out of ten people still do not have access to improved water sources (United Nations Children's Fund [UNICEF] and WHO, 2015).

Ghana ranks 138 out of 187 on the Human Development Index (HDI), a measurement of human development (United Nations Development Programme [UNDP], 2014) but still struggles with poor sanitation and non-potable water. With an estimated population of 25.9 million people (WHO and UN partners, 2015), 89% of Ghanaians have access to improved water sources with the majority living in urban settings (WHO/UNICEF, 2015). These improved water sources include piped water, public tap/standpipe, borehole, protected dug wells/springs and rainwater harvesting and have increased overall access. Unfortunately, studies in both urban (Kwakye-Nuako et al., 2007; McGarvey et al., 2008) and rural (Anim, Nyame and Armah, 2010) settings have shown that improved water sources are often contaminated.

It has been well established overall country mortality is attributable to the lack of access to potable water sources, specifically the mortality due to diarrhea (Green, Small & Casman, 2008; Whelan & Willis, 2006). Water quality improvements may have a minimal impact when sanitation conditions are poor (Eisenberg, 2007). According to UNICEF, only 15% of Ghanaians have improved sanitation facilities which would ensure hygienic separation of human excreta from water and/or soil (WHO/UNICEF, 2015). This problem is most apparent in rural communities where sanitation can include open pit latrines near surface waters that double as primary water sources. A local water quality study in the region in 2011 (Ayeh-Kumi, personal communication, November 2011) and another study of similar water sources in Ghana (Kumasi, Obiri-Danso, & Ephraim, 2011) have

confirmed high levels of fecal contamination. A substantial number of people continue to use these contaminated ponds and rivers as primary water sources. (Anim et al., 2010).

This lack of sanitation can lead to a cycle of diarrhea disease especially in vulnerable populations such as pediatric. For children under 5 years of age, diarrheal disease remains the 6th leading cause of death (WHO, 2015; GSS, 2010). A survey from Ghana Statistical Services (GSS), Ghana Health Services (GHS) and ICF Macro (2009) reported at least 20% of children under 5 years old had diarrhea in the past 2 weeks. In a recent study of diarrheal disease in infants and young children in communities from Africa and Asia, Kotloff et al. (2013) found there was a common pattern of illness due to four common waterborne pathogens: rotavirus, Cryptosporidium, Escherichia coli, and Shigella. By preventing fecal contamination through education and appropriate water treatments, this disease burden can be reduced (Opryszko et al., 2013). The lack of water infrastructure requires point-of-use treatment at individual households but several recognized barriers exist to the treatment of drinking water. They include cost to treat, knowledge of proper treatment methods, and access to necessary materials (Phaswana-Mafuya, 2005).

We believe this study will establish an understanding of local water use practices and how they relate to diarrheal disease in the Kwahu East district of Ghana. This information is fundamental in determining the most sustainable methods of improving water access and quality.

Methods

Data collection

A cross-sectional study using a home sampling approach was conducted among the following villages in the Kwahu East district of Ghana: Awisesu, Chunwa, Deduekro, Miaso, Nteso, Odumase, Oframase, Ohemaa, and Oworobong. The survey and methods were approved by the New York Institute of Technology Institutional Review Board (BHS-629) and reviewed by the Noguchi Memorial Institute for Medical Research, University of Ghana, Legon-Accra.

This survey consisted of four main sections: demographics, water use practices, water related illness, and water related sanitation. The questionnaire was translated into a standard version of the native language of the region, Twi, by trained translators provided by The Rohde Foundation, a 501(c)(3), Non-Governmental Organization (NGO). The collection of survey data was completed in June 2010.

Data Analysis

Statistical analyses were performed using SPSS, version 18.0 for Windows (SPSS Inc; Chicago, IL). Descriptive statistics were calculated for

each variable and reported as mean and standard for quantitative variables and counts and percentages for qualitative variables. Comparisons of continuous variables were performed using Student's t-test for independent samples and analysis of variance (ANOVA). Comparisons of categorical variables were performed using χ^2 tests. P-values less than 0.05 were considered significant.

Results

Demographics

There were 236 household surveys completed with 44.5% (n = 105) surveys answered by a male, 55.0% (n = 130) surveys by a female, and 0.4% (n = 1) unreported. For study participants location, 28.9% (n = 68) were from Oworobong, 21.2% (n = 50) from Odumase, 11.0% (n = 26) from Miaso, 9.3% (n = 22) from Ohemaa, 6.4% (n = 15) from Awisesu, 4.7% (n = 11) from Chunwa, 4.2% (n = 10) from Deduekro, 3.4% (n = 8) from Oframase, 2.1% (n = 5) from Nteso, 0.4% (n = 1) from Accra, and 8.5% (n = 20) unreported. Respondents between the ages of 18-29 years made up 38.7% (n = 91) of survey participants. As for other age groups, 17.4% (n = 41) were between the ages of 30-39 years, 11.9% (n = 28) between 40-49 years, 16.6% (n = 39) between 50-59 years, and 15.3% (n = 36) over 60 years. The average number of people in a household was 6.43 (SD = 4.25). The number of children under the age of 18 living in a household was 2.94 (SD = 2.59).

Education

Respondents who reported no formal education made up 27.1% (n = 64) of survey participants, 11.9% (n = 28) reported 1-3 years, 14.8% (n = 35) reported 4-6 years, 22.5% (n = 53) reported 6-8 years, and 23.7% (n = 56) reported 8 or more years. Based on these groupings, there was no significant difference in education level between genders [$\chi^2(4) = 8.403$, $p = 0.078$]. The variable was recoded into a continuous variable by taking the average of each grouping. For example, those who reported 1-3 years were re-coded as having 2 years of education. Males had a mean number of years of education of 5.35 (SD = 3.42), and for females, the mean years of education was 4.17 (SD = 3.56). Results from a Student's t-test for independent samples showed that males had a statistically significant greater number of years of education than females [$t(233) = 2.579$, $p = 0.011$].

There were significant differences between age groups and level of education [$\chi^2(16) = 36.401$, $p = 0.003$]. Those in the ≥ 60 years age group were more likely to have no formal education as were those in the 50-59 years age group. In contrast, those in the 19-29 years age group were more likely to have a formal education.

Water collection practices

The majority of respondents reported surface water and/or pump-well/borehole as their main sources of water. More than 90% of respondents indicated that they thought water collection took “very little time” out of their day. Seasonal variation of water collection was noted.

One hundred-forty one (141) households reported females as the sole water collector, and 58 households reported males as the sole water collector. Thirty-five (35) households reported both males and females water collectors. The most frequently reported water collector was a female over the age of 15 years. Household size and number of children under the age of 18 years in the household affected who collected water. In larger the household sizes, younger children (males aged 10-14 years and females aged 10-14 years) collected more frequently.

The mean household size that used a male collector between the ages of 10-14 year was 8.07 (SD = 6.09), and for those who did not, the mean household size was 6.03 (SD = 3.59) which was significantly different [$t(229) = 2.943, p = 0.004$]. There was also a statistically significant difference [$t(228) = 4.465, p < 0.001$] in household size who used a female collector between that ages of 10-14 years (mean = 9.07, SD = 6.40) and those who do did not (mean = 5.88, SD = 3.46). (Figure 1). The mean number of children in a household who reported a male collector over the age of 15 years was 2.09 (SD = 1.96) compared to a mean number of children of 3.15 (SD = 2.69) who did not use a male collector over the age of 15 years. This difference was statistically significant with smaller households using males over the age of 15 years more often [$t(88.625) = -2.993, p = 0.040$].

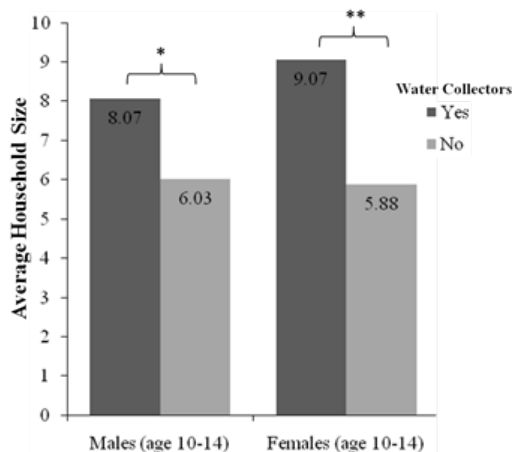

Figure 1. Differences in average household size between those who use female or male water collectors ages 10-14, and those who do not. Households reporting both males and females ages 10-14 as water collectors were significantly larger than those that did not. (* $p < 0.05$; ** $p < 0.01$)

Water treatment and sanitation

The majority of respondents (90.3%) not treating water prior to consumption indicated that there was “there is no need” (46.5%). Data also indicated 95.1% (n = 224) of survey participants were willing to learn water treatment techniques if taught. When asked about their primary toilet facilities, 97.0% (n = 229) of respondents reported using a pit latrine as their primary toileting facility. The survey also revealed that 66.5% (n = 157) of respondents believed human waste remained in the soil or ground and 25.2% (n = 59) reported that “they did not know.”

Knowledge surrounding waterborne disease

There were significant differences in identification of symptoms between genders, education level and age groups.

Gender

There was a significant difference between genders in the correct identification that diarrhea comes from contaminated water [$\chi^2(1) = 10.058$, $p = 0.002$]. Males selected diarrhea more frequently than expected. There was also a significant difference in gender for the “disease does not come from water” [$\chi^2(1) = 7.643$, $p = 0.006$]. With this, females selected “diseases does not come from water” with greater frequency than expected.

Education

There were differences between education levels in possible symptoms from the ingestion of contaminated water. In particular, the correct identification of diarrhea [$\chi^2(4) = 9.773$, $p = 0.040$], eye/vision problems [$\chi^2(4) = 14.415$, $p = 0.006$] and the selection of “disease does not come from water” [$\chi^2(4) = 9.680$, $p = 0.046$] were significantly different between those who self-reported a formal education and those who self-reported no formal education.

Age

There were also significant differences between age groups in the correct identification of diarrhea [$\chi^2(4) = 20.524$, $p < 0.001$], stomach pain [$\chi^2(4) = 24.200$, $p < 0.001$], weight loss [$\chi^2(4) = 19.512$, $p = 0.010$], malnutrition [$\chi^2(4) = 19.218$, $p = 0.001$], eye/vision problems [$\chi^2(4) = 19.502$, $p = 0.001$] and fever [$\chi^2(4) = 25.432$, $p < 0.001$] (Figure 2). Respondents in the ≥ 60 years age group failed to identify diarrhea, stomach pain, weight loss and more frequently than expected. Those in the 19-29 years age group identified diarrhea, malnutrition, weight loss, vision problems, and fever with better frequently than expected. Finally, three groups were created based on the number of symptoms identified: 1) 0-2 symptoms, 2) 3-5 symptoms, 3) 6-7 symptoms. There was a significant association between age group and the number of symptoms identified [$\chi^2(8)$

= 33.053, $p < 0.001$]. The youngest age group identifying more symptoms associated with contaminated water than the older age groups.

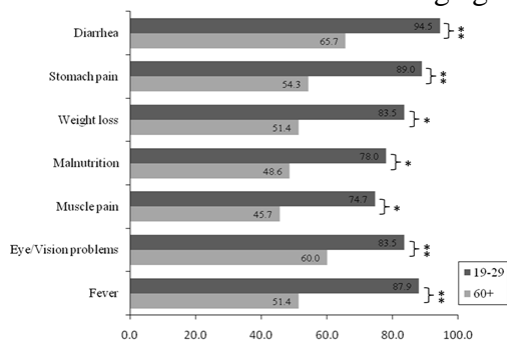

Figure 2. Differences between age groups in symptom identification. There were significant differences between the 19-20 and the 60+ age group each of the items depicted. (* $p < 0.05$; ** $p < 0.01$)

Discussion

This study gathered information regarding current practices related to water collection, water treatment, and perception of waterborne illness in the Kwahu East district of Ghana. Several significant factors were investigated in this survey that provided insight in creating culturally appropriate and sustainable health interventions.

Water Use Practices

Consistent with the DHS for rural Ghana, the majority of water collectors were females over 15 years of age (GSS et al., 2009). However, we also found larger households were more likely to report males and females between 10-14 years of age as water collectors. For smaller households with fewer children under the age of 18 years, males over the age of 15 years were also reported as the water collectors. The majority of respondents indicated water collection took very little time which is also consistent with the DHS findings that 8 in 10 rural households reported it took less than 30 minutes to obtain drinking water (GSS et al., 2009). Our survey indicated that community members used both improved water sources as well as surface water sources. The proximity to various sources may dictate which type is utilized more frequently.

When implementing any form of intervention targeting all age groups and genders, seasonal variations should be anticipated. Data for climate models have shown a temperature increase of 3.6 degrees Celsius in the Volta Basin in Ghana over the next century would decrease not only surface water sources but also shallow groundwater (McCartney et al., 2013). In the dry season with more water scarcity, community members may have a predilection for surface water even if they know it is contaminated because of ease of access (McClain, 2013). Conversely, climate change can also

result in an unpredictable increase in precipitation that can lead to flooding and runoff causing a higher risk of cross-contamination between clean water sources and fecal waste (McClain, 2013). With this evidence, there is a need for the ongoing development of improved water source infrastructure in the region.

Understanding of disease burden

Discrepancies in diarrheal disease understanding among individuals in our surveyed region may reflect confusion at the community level. A difference may exist between what individuals have been taught in the school setting versus at home. Gyimah (2003) found the risk of diarrheal disease was highest for children in households without toilets and piped water, but the risk was even higher for those whose mothers had less formal education. Another study found general community knowledge can affect the overall knowledge of the individual (Andrzejewski, Reed and White, 2009). These studies support a unified, community approach to diarrheal disease prevention.

Impact of gender on disease knowledge

In the survey, male participants were more knowledgeable about the association between the consumption of contaminated water and diarrheal disease. Our data attempts to explain this difference by showing males had significantly more number of years of education. This gender disparity in education indicates a greater need for education among women and girls as related to diarrheal disease.

Impact of age on disease knowledge

Younger age groups were more likely to associate the consumption of contaminated water with diarrhea and associated symptoms than older age groups. The difference may lie in the evolution of the education curriculum to include information about waterborne illness. In 2000, an educational intervention developed by United Nations Educational, Scientific and Cultural Organization (UNESCO), UNICEF, WHO and the World Bank was initiated in Ghana entitled Focusing Resources on Effective School Education (FRESH) (Joerger & Hoffmann, 2002). FRESH has worked with the Ghanaian government in order to introduce health, hygiene, and nutrition education into the formal curriculum of 577 schools reaching 83,000 students (The World Bank, 2011). Therefore, any interventional program should target non-school attending community members to address the shortcomings of prior educational practices.

Limitations

There were a number of limitations with this study. During the development of the questionnaire, some of the words could not be directly translated into Twi. The modification of words could have altered the meaning of the original questions and introduced a source of bias.

Furthermore, some villages spoke different dialects other than Twi requiring assistance from untrained translators. The cultural perception of the research team in the community may have also led to a Hawthorne effect. The clinic consistently received more patients during the days the research team physicians were present suggesting the local community viewed them differently. These physicians were also responsible for assisting in the conduction the survey creating the potential bias.

Future directions

The results of this study can be a basis for the development of site specific interventions for safe water practices and improved hygiene. Water issues can become major obstacles to the development of impoverished countries affecting health, social well-being, and economic productivity (Elimelech, 2006). The survey suggests there is a desire from the respondents to treat their water, but they lack the knowledge and materials to do so. There is a need for additional research to determine the most culturally appropriate interventions aimed at water treatment to prevent any hindrance for economic development within this district.

The survey results can also be used to develop programs to improve education among community members regarding health, sanitation, and waterborne illnesses. Survey responses suggest an educational intervention relating health outcomes with contaminated water consumption may be best targeted to older age groups. However, additional programs on this topic involving the general population would also benefit all age groups to ensure a complete and accurate knowledge. It would also be beneficial to provide educational programs about general sanitation and hygiene practices as well as the association between human waste and water contamination.

Conclusion

This study gathered information regarding cultural practices relating to water collection, water treatment, and perception of waterborne illness in the Kwahu East district of Ghana. Water collection and treatment methods were similar to other areas of rural Ghana. We found household demographics, gender, education, and age all play significant roles in water collection practices and knowledge about related diseases. This collective information is vital in determining potential interventions of improving access to safe drinking water thereby decreasing the risk of waterborne illnesses. More research is required to be able to provide effective interventions not only in the Kwahu East district of Ghana but also other regions of Ghana and low-income countries.

References:

- Anim, F., Nyame, F. K., Amah, T. (2010). Coliform status of water bodies from two districts in Ghana, west Africa: implications for rural water resources management. *Water Policy*, 12(5). <http://doi.org/10.2166/wp.2010.013>
- Andrzejewski, C. S., Reed, H. E., & White, M. J. (2009). Does Where You Live Influence What You Know? Community Effects on Health Knowledge in Ghana. *Health & Place*, 15(1), 228–238. <http://doi.org/10.1016/j.healthplace.2008.05.002>
- Joerger, C., & Hoffmann, A. M. (2000). FRESH :A comprehensive school health approach to achieve education for all. Paris: UNESCO. Retrieved from www.unesdoc.unesco.org/images/0012/001255/125537e.pdf
- Eisenberg, J. N. S., Scott, J. C., & Porco, T. (2007). Integrating disease control strategies: balancing water sanitation and hygiene interventions to reduce diarrheal disease burden. *American Journal of Public Health*, 97(5), 846–852. <http://doi.org/10.2105/AJPH.2006.086207>
- Elimelech, M. (2006, December 1). The global challenge for adequate and safe water. Retrieved August 27, 2015, from <http://www.iwaponline.com/jws/055/jws0550003.htm>
- Francis Guillemin, P. H. (1991). Faecal contamination of rural water supply in the Sahelian area. *Water Research - WATER RES*, 25(8), 923–927. [http://doi.org/10.1016/0043-1354\(91\)90139-H](http://doi.org/10.1016/0043-1354(91)90139-H)
- Ghana Statistical Service (GSS), Ghana Health Service (GHS), & ICF Macro.(2009). Ghana Demographic and Health Survey 2008. Accra, Ghana: GSS, GHS, and ICF Macro.
- Green, S. T., Small, M. J., & Casman, E. A. (2009). Determinants of National Diarrheal Disease Burden. *Environmental Science & Technology*, 43(4), 993–999. <http://doi.org/10.1021/es8023226>
- Gyimah, S. (2003). Interaction effects of maternal education and household facilities on childhood diarrhea in sub-Saharan Africa: The case of Ghana. *Journal of Health & Population in Developing Countries*.
- Jamison, D. T., Breman, J. G., Measham, A. R., Alleyne, G., Claeson, M., Evans, D. B., ... Musgrove, P. (Eds.). (2006). *Disease Control Priorities in Developing Countries* (2nd ed.). Washington (DC): World Bank. Retrieved from <http://www.ncbi.nlm.nih.gov/books/NBK11728/>
- Kotloff, K. L., Nataro, J. P., Blackwelder, W. C., Nasrin, D., Farag, T. H., Panchalingam, S., ...Levine, M. M. (2013). Burden and aetiology of

- diarrhoeal disease in infants and young children in developing countries (the Global Enteric Multicenter Study, GEMS): a prospective, case-control study. *Lancet* (London, England), 382(9888), 209–222. [http://doi.org/10.1016/S0140-6736\(13\)60844-2](http://doi.org/10.1016/S0140-6736(13)60844-2)
- Kumasi, T. C., Obiri-Danso, K., & Ephraim, J. (2011). Microbial quality of water in Berekese reservoir and feeder streams in Ghana. *Lakes & Reservoirs: Research & Management*, 16(1), 49–60. <http://doi.org/10.1111/j.1440-1770.2011.00464.x>
- Kuruppu, N. (2009). Adapting water resources to climate change in Kiribati: the importance of cultural values and meanings. *Environmental Science & Policy*, 12(7), 799–809. <http://doi.org/10.1016/j.envsci.2009.07.005>
- Kwakye-Nuako, G., Borketey, P., Mensah-Attipoe, I., Asmah, R., & Ayeh-Kumi, P. (2007). Sachet Drinking Water in Accra: The Potential Threats of Transmission of Enteric Pathogenic Protozoan Organisms. *Ghana Medical Journal*, 41(2), 62–67.
- Lardner, D. A., Meyland, S., Jung, M. K., & Passafaro, M. D. (2014). A collaborative investigation of health impact and water quality improvement in Oworobong, Ghana (pp. 75–86). <http://doi.org/10.2495/WP140071>
- McCartney, M., Forkuor, G., Sood, A., Hattermann, F., & Muthuwatta, L. (2012). The water resource implications of changing climate in the Volta River Basin (No. IWMI Research Report 146) (p. 40). Colombo, Sri Lanka: International Water Management Institute (IWMI)
- McClain, M. E. (2013). Balancing Water Resources Development and Environmental Sustainability in Africa: A Review of Recent Research Findings and Applications. *Ambio*, 42(5), 549–565. <http://doi.org/10.1007/s13280-012-0359-1>
- McGarvey, S. T., Buszin, J., Reed, H., Smith, D. C., Rahman, Z., Andrzejewski, C., ... White, M. J. (2008). Community and household determinants of water quality in coastal Ghana. *Journal of Water and Health*, 6(3), 339–349
- Opryszko, M. C., Guo, Y., MacDonald, L., MacDonald, L., Kiihl, S., & Schwab, K. J. (2013). Impact of Water-Vending Kiosks and Hygiene Education on Household Drinking Water Quality in Rural Ghana. *The American Journal of Tropical Medicine and Hygiene*, 88(4), 651–660. <http://doi.org/10.4269/ajtmh.12-0065>
- Phaswana-Mafuya, N. (2008). An investigation into the perceived sanitation challenges in the Eastern Cape rural communities. *Health SA Gesondheid*, 11(1). Retrieved from <http://www.ajol.info/index.php/hsa/article/view/10326>

- The World Bank. (2011). Rethinking School Health: A Key Component of Education for All. (D. Bundy, Ed.). Washington: World Bank Publications.
- UNICEF and WHO. (2015). Progress on sanitation and drinking water – 2015 update and MDG assessment. Geneva: UNICEF and WHO.
- United Nations Development Programme (UNDP). (2014). 2014 Human Development Report. New York: United Nations Development Programme. Retrieved from <http://hdr.undp.org/en/countries/profiles/GHA>
- Whelan, J. J., & Willis, K. (2007). Problems with provision: barriers to drinking water quality and public health in rural Tasmania, Australia. *Rural and Remote Health*, 7(3), 627.
- WHO and UN partners. (2015). Ghana: WHO statistical profile. Retrieved from http://www.who.int/gho/countries/gha/country_profiles/en/
- WHO/UNICEF: Joint Monitoring Program for Water Supply and Sanitation. (2015). Ghana: Estimates on the use of water sources and sanitation facilities. WHO/UNICEF. Retrieved from www.wssinfo.org/fileadmin/user_upload/resources/Ghana.xls
- World Health Organization (WHO). (2009). Global health risks: mortality and burden of disease attributable to selected major risks. Geneva: World Health Organization. Retrieved from www.who.int/entity/healthinfo/global_burden_disease/GlobalHealthRisks_report_full.pdf?ua=1&ua=1
- World Health Organization (WHO). (2015). Global Health Observatory Data Repository. Retrieved August 21, 2015, from <http://apps.who.int/gho/data/node.main.46?lang=en>

CRITERIA OF THE RETURN TO SPORT AFTER RECONSTRUCTION OF THE ANTERIOR CRUCIATE LIGAMENT

Hussein Alaa Eddine PT, MS.

Hassan Kanso PT, MS.

Houssein Ziab PT, MS.

Hassane Kheir Eddine PT, MS, DPT.

Hassan Karaki PT, MS, PhD.

Faculty of Public Health, Lebanese University, Beirut, Lebanon

Alfred Houry MD.

Instructor , Department of Orthopedics Surgery.

University Medical Center – Rizk Hospital . Faculty of Medicine.

Lebanese American University (LAU) , Beirut, Lebanon

Khodor Haidar Hassan MD, PhD.

Department of Physical Therapy, Faculty of Public Health,

Department of Biology, Faculty of Sciences I,

Lebanese University, Hadath, Lebanon

Department of Health Care in Tourism, Faculty of Touristic Sciences ,
Islamic University of Lebanon .Khalde'.Lebanon

Abstract

Background: Despite the progress of reconstruction techniques for the anterior cruciate ligament (LCA), the return to sport after this surgery remains a challenge. The absence of good knowledge in the measures of appropriate results after ACL rehabilitation can lead the patients to return to play prematurely, making them in front of a high risk of injury again later. Over one-third of athletes are unable to resume their sport at the same level and almost one fifth will suffer from new accident during this recovery, either on the operated knee or contralateral knee. While the fear of another accident remains the biggest obstacle to return to sport, persistent functional deficits is the leading cause of recurrence tear.

Objective: to conduct an environmental study of clinical practice surgeons and physiotherapists decision making in the return to sport (RTS) after ACL ligament; and to gain a better understanding of how clinicians take the suitable decision to back to the sport.

Participants: 34 physiotherapists and 11 orthopedic surgeons are included in this study.

Interventions: Lebanese surgeons and physiotherapists completed distinct and validated questionnaires which consisted of 10 closed questions, each including a sections on demography, outcome measurement, treatment and procedures including the decisions of the RTS.

Data collection: The main measures were the descriptive and subjective collected from orthopedic surgeons and physiotherapists. The use of measures of clinical outcomes by the two groups is qualitatively analyzed for similarities between the professions and criteria recently proposed consensus used to decide the RTS. The level of agreement for the definition of success for the RTS following a ligamentoplasty ACL was explored by the frequency of response for each item.

Results: Analysis of the results show that 90% of participants consider that physiotherapists have a vital role in the decision making to return to sport after ACL reconstruction. In addition, several measurement scales are mostly used for evaluation of ACL as the jump test, Lachman test, pain ... while the analysis of the Pearson correlation between the number of patients taken by year and the criteria of success of the decision to return to ground shows a very weak correlation ($P < 0.452$), which reflects the poor experience of Lebanese physiotherapists in the selection of the factors influencing the return to sport.

Conclusion: The results show a lack of scientific knowledge in the participants on valid tests that can be used for clinical decision-making to return to sport after ACL reconstruction. Future studies are recommended to verify these results with a large number of participants.

Keywords: Anterior cruciate ligament, surgery

Methodology of the research

Hypothesis:

A small number of orthopedic surgeons, physiotherapists and even members of the medical team know the factors that influence on the resumption of sport and clinical rating scales after rehabilitation.

Methods:

- 10 validated and closed questions were asked exploratory surgeons and physiotherapists to consider initial support for the concept of the possibility of expanding the role of physiotherapists in decision making after surgery.
- Items on demographics, measurement scales, treatment protocols and the decision of the RS.

- The statistic was performed based on the analysis of the correlation between the different items that influence decision making back to the sport using the Pearson correlation.

Criteria:

- Inclusion criteria:
 - Specialized in orthopedic knee surgery.
 - Specialized physiotherapists.
 - Physiotherapists who work in specialized centers.
 - Informed Consent.
- exclusion criteria:
 - Non-specialized in orthopedic ACL.
 - Non-specialized physiotherapists ACL.
- Primary choice about the type of the surgery:
 - Kenneth-Jones technique: Most popular with 81,8% of the cases.
 - Graft of hamstring’s and Patella’s tendon: second choice with 9.1 %.

Results:

Fig 1: List by the scales of measure used and that affect the decision.

Fig 2: role of physical therapist in the decision in RTS.

Fig 3: Functional stability: importance factors for the performance.

	Functiona l stability	Participatio n without pain	Participatio n with pain	Canno t do sport	Sport reduce d	Functiona l limitation	Performanc e reduced	None deficit
Nb of patient s	Pea = 0.34 P = 0.049	Pea = 0.185 P = 0.318	Pea = 0.212 P = 0.23	Pea= 0.012 P 0.948	Pea =-0.108 P 0.544	Pea= 0.183 P = 0.309	Pea =-0.416 P= 0.014	Pea = 0.452 P=0,00 7

Pea: pearson

Table showing the corelation between Professional experience pf the physical therapist and the factors that influence the sucess of RTS.

Discussion of results:

- Time: more than 6 months for the Kenneth-Jones (36.4% MD and 32.4% PT) for hamstring's grafting (54.4% MD and 44.1% PT).
- 26.5% of physiotherapists reported more than 5 months for RS.
- Results do not reflect the real situation due to the small number of integrated orthopedic.
- More than 90% of participants consider that physiotherapists have an important role in clinical decision making in the recovery of the sport.
- The standardized terminology for the success of RS facilitates comparisons between studies and provides meaningful goals for the patient during rehabilitation.
- The return to play was not clearly defined in regard to the frequency or type of sport participation. Lynch et al. (2013).
- The definition of return to sport among orthopedists and physical therapists in Lebanon remains a major problem that influences the decision to recover from an ACL injury.
- The Pearson correlation between the number of patients per year and the selection of the SR of success criteria varies in a range of 0.012 and 0.452: not acceptable and reflects the lack of correlation. So no fixed and stable criteria or clear definitions on the resumption of sport.

Scale of measure:

- Participants use a minimum of 4-5 outcome measures.
- Essential tests: jump testing, Biodex, range of motion, Lachman test, pain, edema and functional movements
- Tests Unused: IKDC tests, Marx activity scale Knee, Tegner scale, Lyshlom scale, KT-1000 and ACL - RSI scale
- Contradiction on the criterion of knowledge: bad pain sucked in the criteria of the RTS or even their definition.
- Time constraints clinicians: obstacle to participation in research and perhaps contributed to the low survey response.
- Despite a minimal number of questions, the non-response rate was high for all groups.
- We cannot say that these results objectively reflect the real situation of all physiotherapists and orthopedic surgeons Lebanon.

Conclusion

- The role of physiotherapist in the clinical decision remains unclear and is not well known.
- Most orthopedic and physiotherapist uses more than four analytical scales such as jumping tests, Biodex, range of motion, Lachman test, pain, swelling and functional movements

- Lack of information regarding analytical test and overall test (IKDC Knee. Marx), and even the psychological test (ACL RSI-scale).
- The functional stability: an important factor in making sports recovery decision in participants.
- Contradiction between the participants about the other factors.
- The KJ and hamstring graft are the two most widely used techniques with a delay of more than six months for the resumption of sport

References:

- Huston Li et al. Anterior cruciate ligament injuries in the female athlete. Potential risk factors. *Clin Orthop Relat Res.* 2000; 372: 50–63.
- Myklebust G, Bahr R. Return to play guidelines after anterior cruciate ligament surgery. *Br J Sports Med.* 2005 Mar;39(3):127-31
- Kamandulis et al. Reliability and validity of DPAL testing after anterior cruciate ligament injuries: risk factors and prevention strategies. *J Am Acadorthop surg.* 2012; 48(2):84-90.
- Griffin LY, Agel J, Albohm MJ, et al.: Non-contact anterior cruciate ligament injuries: risk factors and prevention strategies. *J Am AcadOrthopSurg.* 2000; 8: 141–150.
- Filbay SR et al.related quality of life after anterior cruciate ligament reconstruction: a systematic review. *Am J Sports Med.* 2014 May; 42(5):1247-55.
- Gerald McGinty a, James J. Irrgang a, b, Dave Pezzullo. Biomechanical considerations for rehabilitation of the knee. *Clinical Biomechanics.* 2000; 15:160-166.
- Naoko Aminaka, Phillip A. Gribble. A Systematic Review of the Effects of Therapeutic Taping on Patellofemoral Pain Syndrome. *J Athl Train.* 2005; 40(4):341-51.
- Michael P. Reiman, Lori A. Bolgla, and Daniel Lorenz. Hip Function's Influence On Knee Dysfunction: A Proximal Link to a Distal Problem. *Journal of Sport Rehabilitation,* 2009, 18, 33-46
- Thore Zantopet al. Anatomy of the Anterior Cruciate Ligament. *Oper Tech Orthop.*2005; 15:20-28.
- Lephart SM, Ferris CM et al. Risk factors associated with noncontact anterior cruciate ligament injuries in female athletes.2002; 51:307-10.
- Engebretsen AH, Myklebust G, Holme I, Engebretsen L .Intrinsic risk factors for acute knee injuries among male football players: a prospective cohort study. 2011 Oct; 21(5):645-52.45
- Krosshaug T, Nakamae A, Boden BP, Engebretsen L, Smith G, Slauterbeck JR . Mechanisms of anterior cruciate ligament injury in basketball: video analysis of 39 cases. 2007 Mar; 35(3):359-67.

- Salmon L, Pinczewski L. Outcome of anatomic transphyseal anterior cruciate ligament reconstruction in Tanner stage 1 and 2 patients with open physes. 2012 May; 40(5):1093.
- Griffin LY, Albohm MJ. Understanding and preventing noncontact anterior cruciate ligament injuries: a review of the Hunt Valley II meeting, January 2005. 2006 Sep; 34(9):1512-32.
- Alentorn-Geli E, Lajara F. The transtibial versus the anteromedial portal technique in the arthroscopic bone-patellar tendon-bone anterior cruciate ligament reconstruction. 2010 Aug; 18(8):1013-37.
- Paterno MV, Schmitt LC, Ford KR, Rauh MJ, Myer GD, Huang B. Biomechanical measures during landing and postural stability predict second anterior cruciate ligament injury after anterior cruciate ligament reconstruction and return to sport. 2010 Oct; 38(10):1968-78.
- Lephart SM, Ferris CM, Fu FH. Risk factors associated with noncontact anterior cruciate ligament injuries in female athletes. 2002; 51:307-10.
- Beynon BD, Johnson RJ, Fleming BC, et al. Anterior cruciate ligament replacement: comparison of bone-patellar tendon-bone grafts with two-strand hamstring grafts. A prospective, randomized study. *J Bone Joint Surg Am.* 2002; 84- A: 1503-13.
- DeAngelis JP, Fulkerson JP. Quadriceps tendon a reliable alternative for reconstruction of the anterior cruciate ligament. *Clin Sports Med.* 2007; 26:587-596.
- Lee S, Seong SC, Jo H, et al. Anterior cruciate ligament reconstruction using quadriceps tendon autograft. *J Bone Joint Surg Am.* 2007; 89(3): 116-126.
- Amis AA, Zavras TD. Isometricity and graft placement during anterior cruciate ligament reconstruction. *Knee.* 1995; 2:5-17. 46
- Aune AK, Holm I, Risberg MA, et al. Four-strand hamstring tendon autograft compared with patellar tendon-bone autograft for anterior cruciate ligament reconstruction. A randomized study with two-year follow-up. *Am J Sports Med.* 2001; 29:722-8.
- Barrett GR, Noojin FK, Hartzog CW, Nash CR. Reconstruction of the anterior cruciate ligament in females: a comparison of hamstring versus patellar tendon autograft. *Arthroscopy.* 2002; 18:46-54.
- Barrett GR, Noojin FK, Hartzog CW, Nash CR. Reconstruction of the anterior cruciate ligament in females: a comparison of hamstring versus patellar tendon autograft. *Arthroscopy.* 2002; 18:46-54.
- Colombet P, Robinson J, Christel P, et al. Morphology of anterior cruciate ligament attachments for anatomic reconstruction: a cadaveric dissection and radiographic study. *Arthroscopy.* 2006; 22:984-92
- Muneta T, Koga H, Mochizuki T, et al. A prospective randomized study of 4-strand semitendinosus tendon anterior cruciate ligament reconstruction

comparing single-bundle and double-bundle techniques. *Arthroscopy* 2007; 23: 618–28.

Muneta T, Koga H, Morito T, et al. A retrospective study of the midterm outcome of two-bundle anterior cruciate ligament reconstruction using quadrupled semitendinosus tendon in comparison with one-bundle reconstruction. *Arthroscopy*. 2006; 22:252–8.

Musahl V, Bell KM, Tsai AG, et al. Development of a simple device for measurement of rotational knee laxity. *Knee Surg Sports Traumatol Arthrosc.* 2007; 15: 1009–12.

Woo SL, Kanamori A, Zeminski J, et al. The effectiveness of reconstruction of the anterior cruciate ligament with hamstrings and patellar tendon .A cadaveric study comparing anterior tibial and rotational loads. *J Bone Joint Surg Am.* 2002; 84-A: 907–14.

Prodromos C, Joyce B, Shi K. A meta-analysis of stability of autografts compared to allografts after anterior cruciate ligament reconstruction. *Knee Surg Sports Traumatol Arthrosc.* 2007; 15:851–856. 47

Krych AJ, Jackson JD, Hoskin TL. A meta-analysis of patellar tendon autograft versus patellar tendon allograft in anterior cruciate ligament reconstruction. *Arthroscopy*. 2008; 24:292–298.

Sun K, Tian S, Zhang J. Anterior cruciate ligament reconstruction with BPTB autograft, irradiated versus non-irradiated allograft: a prospective randomized clinical study. *Knee Surg Sports Traumatol Arthrosc.* 2009; 17:464–474.

Lind M, Menhert F, Pedersen AB. The first results from the Danish ACL reconstruction registry: epidemiologic and 2 year follow-up results from 5,818 knee ligament reconstructions. *Knee Surg Sports Traumatol Arthrosc.* 2009; 17(2): 117-24.

Gillquist J, Messner K. Anterior cruciate ligament reconstruction and the longterm incidence of gonarthrosis. *Sports Med.* 1999; 27(3): 143- 56.

Seon JK et al. Osteoarthritis after anterior cruciate ligament reconstruction using a patellar tendon autograft. *Int Orthop.* 2006; 30(2): 94-8.

Thomee R et al. Variability in leg muscle power and hop performance after anterior cruciate ligament reconstruction. *Knee Surg Sports Traumatol Arthrosc.* 2012; 20:1143-51.

Irvine GB, Glasgow MMS. The natural history of the meniscus in anterior cruciate insufficiency: arthroscopic analysis. *J Bone Joint Surg Br.* 1992; 74-B: 403-5.

Van Grinsven S et al. Evidence-based rehabilitation following anterior cruciate ligament reconstruction. *Knee Surg Sports Traumatol Arthrosc.* 2010; 18:1128- 44.

- Daniel DM et al. Instrumented measurement of anterior knee laxity in patients with acute anterior. *Am J Sports Med.* 1985 Nov-Dec; 13(6):401-7.
- Anderson AF, Lipscomb AB Preoperative instrumented testing of the anterior and posterior knee laxity. *Am J Sports Med.* 1989 ;17:387-392
- Hanten WP, Pace MB. Reliability of measuring anterior laxity of the knee using knee ligament arthrometer. *Phys Ther.* 1987 ; 67:357-359
- Daniel DM et al Instrumented measurement of anterior laxity of the knee. *Bone Joint Surg.* 1985; 67 A: 720-726.
- Hanten WP, Pace MB. Reliability of measuring anterior laxity of the knee using knee ligament arthrometer. *Phys Ther.* 1987; 67:357-359 48
- Highgenboten et al. 1000 and Stryker knee laxity measuring device comparison in asymptomatic subjects. *Am J Sports Med.* 1989; 17:743-746.
- Williams GN et al. Comparison of the single assessment numeric evaluation method and two shoulder rating scales. Outcomes measures after shoulder surgery. *Am J Sports Med.* 1999; 27:214-221.
- Williams GN et al. Comparison of the single assessment numeric evaluation method and the Lysholm score. *Clin Orthop Relat Res.* 2000 ;(373):184-192.
- Shelbourne KD et al. Correlation of a Single Assessment Numeric Evaluation (SANE) rating with modified Cincinnati knee rating system and IKDC subjective total scores for patients after ACL reconstruction or knee arthroscopy. *Am J Sports Med.* 2012; 40:2487-2491.
- Hunt SA, Sherman O. Arthroscopic treatment of osteochondral lesions of the talus with correlation of outcome scoring systems. *Arthroscopy.* 2003; 19:360-367.
- Taylor DC et al. Isolated tears of the anterior cruciate ligament over 30-year follow-up of patients treated with arthrotomy and primary repair. *Am J Sports Med.* 2009; 37:65-71.
- Tamara C. Joshua M. Drouin. Reliability and validity of the Biodex system 3 pro isokinetic dynamometer velocity, torque and position measurements. January 2004; 91:1:22-29.
- Karen K. Briggs. *The American journal of American Orthopedic Society for Sports Medicine* 2009; 51:2:23-29.
- Marx R.G et al: Development and evaluation of an activity rating scale for disorders of the knee. *Am J Sports Med.* 2001; 29:213-218.
- Lentz TA, Zeppieri G Jr, Tillman SM. Return to preinjury sports participation following anterior cruciate ligament reconstruction: contributions of demographic, knee impairment, and self-report measures. 2012 Nov; 42(11):893-901.49
- Kocher MS et al. Reliability, validity, and responsiveness of the Lysholm knee scale for various chondral disorders of the knee. *J Bone Joint Surg Am.* 2004 Jun; 86(6):1139-45.

- Barber-Westin SD, Noyes FR, McCloskey JW. Rigorous statistical reliability, validity, and responsiveness testing of the Cincinnati knee rating system in 350 subjects with uninjured, injured, or anterior cruciate ligament-reconstructed knees. 1999 Jul-Aug;27(4):402-16
- Irrgang JJ et al. Development and validation of the International Knee Documentation Committee subjective knee form. Am J Sports Med. 2001; 29:600–13.
- NATALIE J. et al. Measures of Knee Function. Arthritis Care & Research. 2011; 63(11).
- Roos EM et al. Knee Injury and Osteoarthritis Outcome Score (KOOS): development of a self-administered outcome measure. J Orthop Sports Phys Ther. 1998; 28:88–96.
- Salavati M et al. Knee injury and Osteoarthritis Outcome Score (KOOS): reliability and validity in competitive athletes after anterior cruciate ligament reconstruction. Osteoarthritis Cartilage. 2011;19:406–10.
- Comins J et al. Analysis of the Knee injury and Osteoarthritis Outcome Score (KOOS): a statistical re-evaluation. Scand J Med Sci Sports. 2008; 18:336–45.

PRIVATE HOSPITAL CHOICES OF INFERTILE PATIENTS THAT RECIEVED IVF TREATMENT: A PILOT STUDY

Emrah Cengiz, Prof.

Istanbul University, Turkey

Haluk Ozsari, Assoc.Prof.

Acibadem University, Turkey

Dr. Irfan Akyuz, PhD

Ahmet Tuzcuoglu, PhD Candidate

Haydar Hosgor, PhD Candidate

Istanbul University, Turkey

Abstract

Reproduction and resuming the generation is one of the most important and basic instincts of all creatures. One of the biggest hurdles for the implementation of this instinct is infertility. The aim of this research is to determine the factors and the sources of information which are influential for women choosing IVF treatment in private hospitals, and to investigate the relationship between socioeconomic and demographic characteristics of the patients with these two variables. Main sample of the study is on 184 women who have received IVF treatment. Snowball sampling method was used as a sampling method. For women who have undergone IVF treatment the four most important factors that influence their choice of private hospitals, respectively; are hospital expertise in the field, the opportunity to be able to continue with the same physician during the treatment period, to be compelled and pregnancy success rates of the hospital. Four most important sources of information which are effective in applying to a hospital from the perspective of the patient, respectively; patients who had been treated in the hospital before, information offered to patients by the hospital, radio ads and a relative who works in a hospital.

Keywords: Infertility, IVF (In Vitro Fertilization) treatment, Hospital Choice

Introduction

Infertility; is defined as the inability to become impregnated due to regular unprotected sexual intercourse for a year (Mosher and Pratt, 1991). Vayena and colleagues (2001) define infertility as; being unable to conceive a child despite regular intercourse for at least a year without using any method of birth control in the reproductive lifetime of a couple. Infertility as a problem; leads to important personal and family problems which targets approximately 8-10% of women in their reproductive age, and frequency causes vary from region to region (Lowdermilk et al., 1997). Infertility as a reproductive health problem has started to receive attention in the last 20 years. The World Health Organization (WHO) estimates that there are 60-80 million infertile couple in the world (Denson, 2006). In the last 10 years there have been major advances in the treatment of both female and male infertility. 8-30% of couples in their reproductive age in western world is infertile (Brannstrom etc., 2003), although there are not very clear data, this ratio is estimated 10-20% in Turkey (Yanikkerem et al., 2008).

In health services, patients became active in the end of 1960s. Technological advancements in this era has transformed health services. Parallel to technological advances, and the rise of educational levels, patients who can criticize health services with a high level of awareness emerged. In this context, it is possible to say that patients who have received IVF treatment is also among patient groups with rising levels of awareness and consciousness. Today, more patients want to participate in their own health care and health care processes, and want to learn about their disease-related diagnoses. Especially, a highly sensitive area such as IVF treatment, patient requests come to the foreground. Therefore, the quality and success of health care services offered by hospitals and health professionals should not be seen in this context only, the final decisions of these patients are also effective. (Coban and Kasikci, 2008).

Literature Review: International and national literature were reviewed about the IVF treatment within the scope of the paper and the results are summarized in tables below. In the summarizing process, primarily hospital choices and sources of information of infertile patients related to IVF treatment are given with a deductive approach.

Table 1: Literature Review on Hospital Choices of Infertile Patients that Received IVF Treatment and Information Sources

Author(s)	Year	n	Purpose	Findings
Lass ve Brinsden	2011	175	Determining the factors which are effective for infertile couples to choose private hospital choice	Factors: Hospital success rates in pregnancy, and the advice of a family physician/consultant. Information sources: the advice of friends, radio/television broadcasts, the internet and relevant articles.
Marcus vd.	2005	120	Determining the factors which are effective for infertile couples to choose private hospital choice	Factors: Hospital success rates in pregnancy, and healthcare service quality. Information sources: The recommendation of the hospital's physician
Cai vd.	2014	393	Determining the factors which are effective to choose hospital for IVF clinicians and infertile patients in China	Factors: "physicians attitudes and behaviors towards patients", "hospital success rates in pregnancy", "the distance of the hospital to the patient's home", "have the option to continue with the same physician during the treatment period", and "type of hospital". Factors for the clinicians: Hospital "success rates in pregnancy", "physicians attitudes and behaviors towards patients", "the distance of the hospital to the patient's home", "type of hospital", and "have the option to continue with the same physician during the treatment period".

When the literature is examined; although there are some papers with different contents related to infertility and IVF treatment; it is remarkable that there are no studies on sources of information and the factors that influenced hospital choices of infertile patients that received IVF treatment (Table – 1). Couples who received IVF treatment because of infertility have a tendency to stop the treatment because of some reasons like the psychological burden of the treatment, unable to get conceived and the financial burden of treatment. The studies that investigate the reason of this are summarized in Table – 2.

Table-2: Literature Review on Resasons of Infertile Patients Giving Up the IVF Treatment

Author(s)	Year	n	Purpose	Findings
Sourter vd.	1998	806	Researching the satisfaction of infertile patients about hospitals	Factors: physicians' positive attitudes and behaviors towards patients, informing the patients by physicians, supporting the patients about negative emotional aspects of infertility and better waiting time in hospital
Peddie vd.	2005	25	Determining the factors which are affective to give up IVF treatment for infertile women	The difficulties of the acceptance of infertility, stress of the treatment, unrealistic expectations about the treatment, media and society pressure, insufficient information, physical and emotional pressure between couples.
Rajkhowa vd.	2006	1327		Infertility, unsuccessful treatments, The NHS's (national health system) lack of financial support, financial status of patients, medical and non-medical staff recommendations, psychological stress, restlessness, divorce, moving, and the death of one of the couples
Brandles vd.	2009	1391		Emotional stress factors, the inability to predict the outcome of the disease, and refusal of treatment by patients
McDowell ve Murra	2011	1012		Infertility, not choosing advanced treatments because of the possibility of miscarriage, cost, restlessness, stress, age, dissatisfaction about hospital and recommendation of physician to give up the treatment
Gameiro vd.	2012		The physical and psychological burden of treatment, pregnancy success rates in the hospital, divorce, the loss of hope and the refusal of treatment, the death of a couple or a member in the family, hospital distance, adoption, giving up having children, postponement of treatment, the body mass index of the patient,, narrow comprehensive private health insurance, other health problems, choosing an another hospital, and alternative therapies
Pedro vd.	2013	348		Researching the relationship between patient-centered treatment and general infertility treatment

Elimination the causes of giving up the treatment is important especially in increasing the eligibility of hospitals with IVF centers. As a

result, attempts to prevent such negative experiences of patients can make positive contribution to the hospital choices of patients and therefore patients who are satisfied with the services they received in the hospital, will recommend the hospital to other patients (Table - 2).

There are limited studies on factors that influence prenatal clinic choice for other patient groups and patients that received IVF treatment especially pregnant women. Current studies are summarized in Table – 3.

Table 3: Literature Review on Factors That Affect Hospital Choices of Pregnant Women

Author(s)	Year	n	Purpose	Findings
Phibbs et. al	1993	61436	Determining the factors which are affected by low and high-risk pregnant women's hospital choice	Factors: Quality, price, hospital type, and hospitals' location, High-risk women group for pregnancy, prefer better the hospitals compared to women who have a lower risk in terms of quality, and they are willing to travel further to reach that hospitals.
Empel et al.	2011	1152	Determining and comparing the importance of being patient-centred in pregnancy for patients and physicians	Being patient-centered in pregnancy is more important for patients than physicians.
Karkae et al.	2013	258	Determining the factors that are effective to not choose the birth centers in Nepal	Factors: Unopportunity of surgery, lack of medical infrastructure, inexperienced medical personnel.

Although there are not many studies on hospital choices of infertile patients that received IVF treatment, there are many studies on factors that affect hospital choices of patients for general health services. These are summarized in Table -4.

Table 4: Literature Review on Factors That Affect Hospital Choices of Patients For general Health Services

Author(s)	Year	n	Purpose	Findings
Angus et.al	1996	Determining the factors which are effective in choosing gynecology clinics	Reasons for the preference: better waiting time, hospital's proficiency&reputation, concerning the patients, health services presentation rates, loyalty to the hospital Sources of information: Clinical history of referred patients, personel information of clinicans, W.O.M, hospital's promotional products.
Bós and Bós	2004	7920	Analysing the impact of individual and family income on the hospital choices of the adults.	It was found that family income to access to private hospitals, has more importance than individual income, and there is a relationship between family income and private hospital choice approximately %20 percentage. In addition, it is revealed that hospital choice of adults depends on the financial resources of family not on individual resources.
Tai et al	2004	1702	Examining socio-economic/demographic variables that affect patients hospital choice.	Factors: marital status, income, education (also found that female patients prefers close hospitals on the other hand this choice changes according to income&education)
Ho	2006	434	Investigating the relationship between hospital type and the severity of the disease	The severity of the disease varies hospital choice. Also, cancer patients' most significant criteria is the number of nurses per bed.
Leister and Strausberg	2007	151	Determining the factors that affect hospital choice	While the patient experience and physicians' references about hospitals are effective to choose hospitals, distance of the hospital is uneffective
Cruppé and Geraedts	2011	48	Determining the factors that affect hospital choice	Factors: receiving health care services from the hospital before, the distance hospital to the patient's home, and hospital's proficiency The most important source of information is relatives.

Ringard and Hagen	2011	1596	Investigate the relationship between increased geographical mobility opportunity-patients' choices and waiting times in hospitals	Patients who have not chosen the hospitals in their region, are waiting less than 11 week compared to other patients.
Birk and Henriksen	2012	240	Examining the factors that are effective on Danish family physicians hospital choices on behalf of their patients	Factors; the distance to the hospital, family physicians as a serious reference source and family physicians with the excellent cooperation between departments. Information sources; reviews of other family physicians about the department and other patients.
Jannati et.al	2013	376	Determining the factors that affect the decisions of patients' public and private hospital choices in Tabriz and Iran	Factors; possibility of delivery to the hospital by ambulance, the physician's advice, the family's income, type of health insurance, the hospital's service quality, the treatment costs, and informed by physicians.
Loh et .al	2015	28	Determining the place of the best care for cancer patients in the terminal stage	Above %88 of samples noted that home is the best place for terminal term care.

In Turkey, there aren't many studies which is directly relevant to this topic. Additionally, there are limited studies related to the factors that affect general hospital choices and sources of information. Current studies are summarized in Table – 5.

Table-5: Results on National Review on Factors That Affect Hospital Choices of Patients For General Health Services

Author(s)	Year	n	Purpose	Findings
Tengilimoğlu	2001	869	Determining the factors which are effective hospital choice	Factors; hospital distance, the hospital's modern equipment and physical conditions, the prestige of the hospital, the cost of treatment, social security status, bureaucratic processes, and the presence of any kind of health services and the professional.
Akinci et.al.	2004	869	Determining the factors which are effective hospital choice	Factors; hospital distance, hospital image, the hospital's physical appearance, and infrastructure and technology

Ayhan&Canöz	2006	235	Examining public relations activities affecting hospital choices	Factors: hospital image, insurance agreement between the institution of the hospital, the recommendation of a friend, hospital distance, the cost of treatment, providing appropriate health care services for people of different religious beliefs.
Adaman et.al	2009	370	Investigating social networks that affect hospital choice	High-level social networks (close interpersonal relationships) of households can use these networks to access to the hospital.
Tengilimoğlu et.al.	2008	971	Examining public relations activities affecting hospital choices	It is found that most important PR activity is attitudes and behaviors of health professionals towards their patients in the hospital.
Kılınç	2009	550	Determining the socioeconomic and demographic factors which are effective hospital choice	It is determined that no statistically significant difference between patients to prefer public or private hospitals and the status of being previously received health care services from the same hospital and waiting times in the hospital.
Özdemir et.al.	2010	569	Examining which demographic variables related to patients hospital choices after the social security reform	Significant factors: hospital type, social security type, age, marital status, education and income. Not significant factors: gender and employment status
Taşlıyan and Gök	2012	306	Examining the factors affecting patient satisfaction	Past experience and quality of health service are the most important factors.
Özkoç	2013	6938	Determining the socioeconomic and demographic factors which are effective hospital choice	Most preferred hospital types: state hospitals, family health centers, private hospitals, university hospitals, private practice, polyclinic doctors Factors:gender, income levels, settlements, employment status and hospital types
Öztürk	2014	300	Examining the reasons of the choice of the hospital and perceived health service quality	If the perceived health quality is higher than expected service quality; patients prefer the same hospital again. In addition, both ambulatory and hospitalized patients prefer being treated in university hospitals with the hope of a better treatment.

Aim of the Research: The aim of this study is to determine the factors and information sources which affect private hospitals choices of infertile patients who receive IVF treatment and to analyse the relationship between these two variables, socio-economic and demographic variables.

Research Method: Due to impossibility to reach clear number of patients having a child or not after IVF treatment of private hospitals in Turkey and incomprehensive sampling frame that includes not enough individuals, non-probability sampling techniques (Gegez, 2014, 217-218) such as convenience and snow ball methods were used together. Tavşancıl(2002), Gözüm and Aksayan (2003) proposed that sample size has to be 5 or 10 times greater than scales item total. Therefore, in this study, due to the fact that on the scale has 35 questions, it was aimed to reach at least 175 patients that is 5 times of the items on the scales, and 184 patients was reached in total. In the scope of the study, a questionnaire method was conducted as data collection. Scale items was created by the researchers after literature review and having expert opinions (linguistic and marketing experts). In addition, final questionnaires were revised by a pilot study.

It was thought that physician's reputation could be an important factor of hospital choice for some patients and seven in-depth interviews were analyzed. It was found that two patients among seven interviews choose not only hospital but also physician. These results showed that it is not necessary to include any specific questions into the scales about physicians.

Analysis of data, which collected between the dates of June 5th, 2015-15th May 2015, are reviewed as basic statistical methods such as frequency, percentage, average and correlation analysis by using SPSS 20.0. Cronbach's Alpha coefficients have been calculated respectively; 0,780 (20 Variables) for hospital choice factors and 0,691 (15 Variables) for information sources. The scale has been considered reliable because the value of Cronbach's Alpha reliability coefficient is more than 0.70.

The survey consists of three parts. In the first section; 20 statements to determine the factors affecting participants' private hospital choice, in the second section 15 statements including information sources, and in the last section 11 socio-demographic questions are involved. In the first section likert type scale was used (1 is strongly disagree and 5 is strongly agree). In the second section, a five point interval scale used in the form 1 (Unimportant), 3 (Neutral), and 5 (Very Important).

Figure 1: Research Model

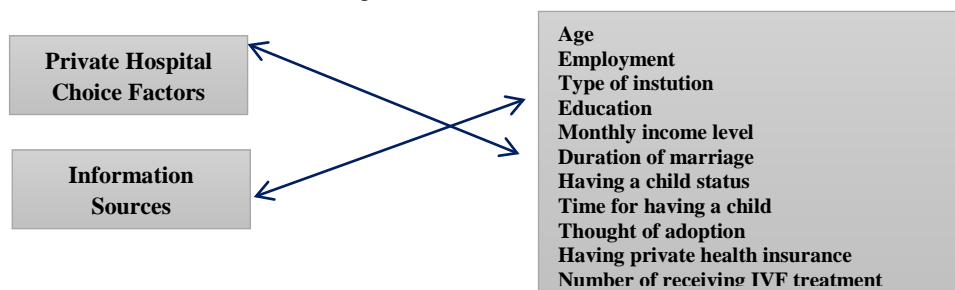

Limitations: In the study, due to impossibility to reach clear number of patients receiving IVF treatment in Turkey, selected sample techniques constitute one of the most important limitations. An another important limitation is that patients can be reluctant to receive this treatment because of avoiding to be perceived as infertile in the community and so this subject is accepted that has the high level of intimacy for couples. In addition this subject's psychological sensitiveness for families and infertile couples caused some problems to reach the patients receiving this treatment and data collection.

Findings: Socioeconomic and demographic characteristics of the participants are summarized in Table 6 via frequencies and percentages.

Table-6: Socioeconomics and Demographics Characteristics of Participants

Age	f	%	Education	f	%
24-28	33	17,9	Primary school	26	14,1
29-33	55	29,9	Middle school	17	9,2
34-39	54	29,3	High school	35	19
40 and above	42	22,8	Associate Degree	30	16,3
Employment	f	%	Undergraduate	42	22,8
Employed	136	73,9	Graduate	23	12,5
Unemployed	48	26,1	Ph.D	11	6
Type of Instution	f	%	Monthly income level (TL)	f	%
Public	67	36,4	0-1.000	50	27,2
Private	45	24,5	1.001-2.000	32	17,4
Self employment	26	14,1	2.001-3.000	52	28,3
Other	46	25	3.001 and above	50	27,2
Duration of Marriage	f	%	Time for having a child	f	%
1-5 Years	62	33,7	1-4 Years	88	47,8
6-9 Years	64	34,8	5-9 Years	66	35,9
10 Years and above	58	31,5	10 Years and above	30	16,3
Having a child	f	%	Thought of adoption	f	%
Yes	119	64,7	Yes	23	12,5
No	65	35,3	No	161	87,5
Private Health Insurance	f	%	Number of receiving IVF treatment	f	%
Yes	45	24,5	1 time	62	33,7
No	139	75,5	2 times	59	32,1
			3 times and above	63	34,2
Total: 184					

When the findings from frequency analysis related to the socioeconomic and demographic characteristics are examined, it is revealed that 55 participants(%29,9) of the survey are in the range of 29-33 age group, and the average age of all participants is $35,55 \pm 6,239$. While 136(%73,9) of participants are actively working, 67 (%36,4) of them are working in the public sector. When the education level of participants is examined, it is observed that the majority of participants 42 of them(%22,8) are at the undergraduate level. While 52 (%28,3) of participants have between 2001-3000 TL monthly average income, the average monthly income of all is 2.440. 62 (%33,7) of participants have the time of marriage between 1-5 years, 119 (%64,7) of them have at least one child. When spending time to have a child is examined, it is found that the highest number is 88 individuals(%47,8) between 1-4 years. 161 of participants(%87,5) do not think adopting a child. 139 of them(%75,5) don't have any private health insurance. Examined the numbers of IVF treatment, it is revealed that 63 (%34,2) individuals received at least 3 times. (as seen at Table 6)

Table-7: Means of Hospital Choice Factors

Factors that Affect Hospital Choice	\bar{X}	ss
Proficiency of hospital	4,67	0,697
Having the same physician during the treatment period	4,58	0,656
Compulsion	4,53	0,880
Pregnancy success rates of the hospital/clinic	4,48	0,843
Service quality of hospital/clinic	4,48	0,652
Ability to reach physicians at any moment	4,43	0,793
Physicians' positive attitudes towards patients	4,10	0,740
Having modern equipments	4,07	0,773
Physicians' communication skills	4,07	0,790
Having physical modern conditions of the hospital/clinic	3,96	0,812
The hospital/clinic's reputation in the community	3,79	1,058
Minimum of waiting time in the hospital/clinic	3,74	1,265
The advice of a close friend	3,46	1,317
Low cost of treatment	3,43	1,462
Distance to home	3,21	1,434
The advice of a relative	3,09	1,598
Distance to workplace	2,95	1,541
Treatment experience	2,08	1,394
Having private health insurance	2,01	1,491
The advice of family physicians	1,78	1,091
Average of Hospital Choice Factors	3,64	1,064

When the table belong to the average of scale affecting the reasons of hospital choice is examined(Table 7); the highest average expression is "proficiency of the hospital" with 4,67 average, the second one is "having the same physician during the treatment period" with 4,58, the third one is "compulsion" with 4,53 average, the fourth highest one is "pregnancy

success rates of the hospital" with 4,48. The lowest average expression is "the advice of family physicians" with 1,78. (Table 7)

Tablo-8: Means of Information Sources

Information Sources	\bar{X}	ss
Information from experienced patients	4,74	0,898
Information from hospital/clinic	4,44	1,075
Radio ads	4,33	1,243
A relative who works in the hospital/clinic	4,10	1,546
Close friends	3,80	1,672
TV ads	3,63	1,709
Relatives	2,96	1,875
Internet ads	2,85	1,806
Facebook-social media ads	2,38	1,588
Close friends who work in the hospital/clinic	2,32	1,780
Billboard ads	1,90	1,268
Magazine ads	1,89	1,367
Family physicians	1,54	1,205
Newspapers	1,37	0,932
Twitter-social media ads	1,34	1,807
Average of Information Sources	2,90	1,451

When the table belong to the average of scale of information sources related to hospital is examined (Table 8), it is found that the highest average expression is "information from experienced patients" with 4,74 average, second one is "information from hospitals" with 4,44; the third one is "radio ads" with 4,33 average, the fourth is "a relative working in the hospital" with 4,10 average. The lowest average item is "Twitter-social media ads" with 1,34 average.

Table-9: The Correlation Between Hospital Choice Factors and Information Sources Means And Socioeconomic And Demographic Data

	Hospital choice mean		Information source mean	
	Pearson Correlation	Sig. (2-tailed)	Pearson Correlation	Sig. (2-tailed)
Age	,066	,372	,016	,824
Duration	-,208**	,005	-,231**	,002
Monthly income level	,563**	,000	,567**	,000
Number of receiving IVF treatment	-,154*	,037	-,138	,063
	Kendall Correlation	Sig. (2-tailed)	Kendall Correlation	Sig. (2-tailed)
Education	,462**	,000	,453**	,000
Employment	-,394**	,000	-,417**	,000
Having a child	-,210**	,001	-,108	,083
Time for having a child	-,169**	,004	-,158**	,008
Thought of adoption	,157*	,010	,056	,365
Private Health Insurance	-,373**	,000	-,215**	,001

** . Correlation is significant at the 0.01 level (2-tailed).

* . Correlation is significant at the 0.05 level (2-tailed).

According to the Pearson Correlation Analysis results, there is a negative relationship between duration of marriage and hospital choice & information sources. When it is considered the psychological and physical burdens of IVF treatment on infertile patients, it can be said that patients can reject the treatment because of unhopelessness in the marriage period or similar reasons. Hence, while the duration of marriage increases, the worthiness of regarding access to information resources and hospital choice factors decreases.

Statistically significant positive relationship was detected between monthly income level and averages of reasons of hospital choice & information sources related to hospital. Accordingly, while income levels of patients increases, possibility of access to information resources increases and hospital choice criteria diversifies. Statistically significant negative relationship was detected between the number of receiving IVF treatment and averages of hospital choice. In this sense, while the number of receiving IVF treatment increases, hospital choice criteria decreases. When it was considered burden of IVF treatment on infertile patients; it can be said that each new treatment increases the level of desperation of patients and because of that patients don't search another new hospital. Statistically significant relationship wasn't detected between number of receiving IVF treatment and average of information sources.

As a result of Kendall correlation analysis; statistically significant positive relationship was detected between education level and averages of hospital choice & information sources. In this case, while education levels of patients increases, possibility of access to information resources and hospital choice criteria increase. So, it can be said that patients with high levels of education have high level of awareness for this type of abrasive treatment. Statistically significant negative relationship was detected between employment status and averages of reasons of hospital choice & information sources. Accordingly, it can be said that working patients cannot allocate enough time for issues of access to information resources and hospital choice because of the intensity of work or similar reasons.

Statistically significant negative relationship was detected between "having a child status" and averages of hospital choice criteria. In this sense, patients having a child after IVF treatment, spend less time for activities related to hospital choice. And this will create hospital loyalty, if these patients want to have a second child, they choose to go the same hospital. There is no statistically significant relationship between "having a child status" and averages of information sources. As found in the duration of marriage, statistically significant negative relationship was detected between "time for having a child" and averages of hospital choice & information

sources. In this sense, increasing of spending time to have a child decreases hospital choice criteria and activities to access to information resources.

Statistically significant negative relationship was detected between “adopting status” and averages of hospital choice criteria. Normally, thought of adopting a child occurs when infertile patients despond from treatment. In contrast in this study, the patients also think adoption in the beginning of the treatment. Statistically significant negative relationship was detected between having private health insurance and averages of hospital choice criterias & information sources. Considering that having a child is a sensitive and important subject for specially infertile patients receiving IVF treatment, it can be said that having a private health insurance does not play an important role neither hospital choice criteria nor information sources. Thereby, patients don't give up from their ultimate goal, even they don't have a private health insurance covering the costs of treatment. Briefly, the lack of private health insurance is not seen as an obstacle to have a child.

Discussion-conclusion&suggestions:

The factors that affect infertile women's hospital choice who received IVF treatment, information sources about the hospital and the relationship between these two variables are investigated in this paper. The five most important factors in the selection of patients respectively are; “hospital expertise in the field of the treatment”, “to continue with the same physician during the treatment period”, “obligation”, “pregnancy success rates of the hospital/clinic”, and “service quality of hospital/clinic”. The five most important information sources that affect the selection of patients respectively are; “patients who had been treated in the hospital/clinic before”, “information offered by the hospital/clinic”, “radio ads”, “a relative who works in the hospital/clinic”, and “close friends”. As a result of correlation analysis; statistically significant relationship wasn't detected between age groups and averages of reasons of hospital choice-information sources. Statistically significant negative relationship was detected between “duration of marriage”, “numbers of IVF treatment received”, “employment status”, “time spent to impregnated”, “having private health insurance” and averages of hospital choice-information sources. Statistically significant positive relationship was detected between “monthly income level”, “education level” and averages of hospital choice-information sources. There is a negative relationship between between “having a child”, “thinking of adoption ” and averages hospital choice, but there isn't statistically significant relationship between “having a child” , “thinking of adoption” and averages of information sources.

According to the findings of this paper, similar conclusions with the literature have been achieved at some point, and different to the literature at

other points. For instance; it has been identified that “hospital success rates in pregnancy” is the most important factor that shapes the preferences of patients in Lass and Brinsden’s (2001) article whereas in this study” hospital expertise in the field of treatment ” replaced it. “Hospital success rates in pregnancy” is the fourth most important factor that shapes the preferences of patients. According to Lass and Brinsden’s article (2001), the distribution of patients information sources about hospital is 26 % a friend's recommendation, 9% radio/television broadcasts, 5% internet and 3% articles on the subject; whereas in this paper radio ads is in the third place, the orientation of a close friend is in the fifth, television commercials are in the sixth, and the internet ads are in the eighth place. In Marcus and colleagues (2005)’s study performed on infertile patients that received IVF treatment, the two most important factors that influence couples hospital choice respectively are; hospital success rates in pregnancy and service quality of hospital. In this paper, the two most important factors respectively are; “hospital expertise in the field of treatment “having the option to continue with the same physician during the treatment period”. In Cai and colleagues (2014)’s article, the five most important factors that influence patients hospital choice respectively are; “physicians attitudes and behaviors towards patients”, “hospital success rates in pregnancy”, “the distance of the hospital to the patient's area of residence, “having the option to continue with the same physician during the treatment period”, and “ hospital ”. In this study, parallel results were found to the results of Cai and his colleagues. In terms of the findings, the most important difference of this study from Lass and Brinsden’s, Marcus and his friends and Cai and his colleagues is the result that patients are obliged to choose a hospital because they are forced. As seen in Table 7 “Obligation”, is one of the factors that affect patients hospital choice, is at the top of the rankings.

In Angus and colleagues (1996)’s article, the most important information sources for patients respectively are; “clinical consequences of patients who have been previously referenced the to physicians”, “personal information of physicians and word of mouth marketing” and “hospitals’ promotional products”. It can be argued that there are different results in this paper when compared to Angus and colleagues’ article and that is family physicians is the less important information source in this paper. Birk and Henriksen (2012)’s article shows that, the most important information source for patients are family physicians reviews on patients about hospitals. In this paper, family physicians is the less important information source. Quality of healthcare services in IVF treatment can affect intentions of patients adherence to treatment according to Pedro and colleagues (2013)’s article. Similarly, service quality is the fourth most important factor that guides patients in the hospital choice according to the findings of this paper.

According to Leister and Strausberg (2007)'s article, patient experience is important for hospital choice and patients choose hospitals referenced by physicians in particular. The distance of the hospital to the patient's area of residence and/or the workplace is less important selection criteria.

As an overall evaluation; there is no research about the factors and information sources that guides hospital choice of infertile patients order to receive IVF treatment in Turkey. There are only a few research about this subject in international literature, too. Infertility as a disease that has a momentum on the increase day by day in the world and it is a traumatic event affecting not only women, but also their husbands and family members to the extreme. On the other hand, another important issue is that healthcare institutions need to know their patients response in increasing health care demands. So health care managers and/or marketers ability to use the instruments as an information source is important. Considering the information sources that are obtained at the end of the study, the first place is taken by patients as an information source who have obtained health service from the hospital before. A Good health manager/marketer need to know that the only way to ensure the sustainability of the health care institutions is patient satisfaction. It is possible to increase the hospital's eligibility, especially through word of mouth marketing. Another instrument according to the findings of the study; is information offered to patients by the clinic. If patients are informed about the process it is possible to create loyal patients. If it is assumed that all loyal patient references at least one patient, grasping the significance of the event would be a little easier. Examples of good practice will make easier to reach the ultimate goals for the patients and their relatives as well as health service providers.

In conclusion, the ultimate goal of patients and their relatives is having a healthy baby, and the ultimate goal of health service providers is to increase the loyal patient portfolio and market share in the industry. It may be recommended that researchers can make new research on other reproductive methods except IVF treatment similar to this research with larger sample volumes in the future.

References:

- Adaman, F; Ardiç, O.P; Erus, B&Tüzemen, D.(2009) "Hospital Choice: Survey Evidence from Istanbul". Turkish Studies, 10(3), 443-468.
- Akıncı, F; Esatoğlu, E; Tengilimoğlu, D&Parsons, A.(2004) "Hospital Choice Factors". Health Management Quarterly, 21(1), 3-19.
- Angus, W; Cotton, L&Cotton, S.(1996) "Purchasing Health Care Services: Information Sources and Decisional Criteria". Journal of Marketing Management, 12, 714-734.

- Ayhan, B&Canöz, K.(2006) “Hastaların Hastane Tercihinde Etkili Olan Halkla İlişkiler Faaliyetleri”. II. Ulusal Halkla İlişkiler Sempozyumu: 21. Yüzyılda Halkla İlişkilerde Yeni Yönelimler, Sorunlar ve Çözümler, 2006, 71-89.
- Birk, H.O&Henriksen, L.O.(2012) “Which Factors Decided General Practitioners’ Choice of Hospital on Behalf of Their Patients in an Area with Free Choice of Public Hospital? A Questionnaire Study”. BMC Health Services Research, 12(126), 1-10.
- Brandles, M; Steen, J.O.M; Bokdam, S.B; Hamilton, C.J.C.M; Bruin, J.P; Nelen, W.L.D.M&Kremer, J.A.M. (2009),“When and Why Do Subfertile Couples Discontinue Their Fertility Care? A Longitudinal Cohort Study in a Secondary Care Subfertility Population”. Human Reproduction, 24(12), 3127-3135.
- Brannstrom, M; Wranning, C.A&El-Akouri, R.R.(2002), “Transplantation of Uterus”. Molecular and Cellular Endocrinology, 177-184.
- Bós, A.M.G& Bós, A.J.G. (2004),”Determinantes Na Escolha Entre Atendimento de Saúde Privada e Pública por Idosos”.Rev Saúde Pública, 38(1), 13-20.
- Cai, Q,F; Wan, F; Dong, X.Y; Liao, X.H; Zheng, J; Wang, R; Wang, L; Ji, L.C; Zhang, H.W.(2014)“Fertility Clinicians and Infertile Patients in China Have Different Preferences in Fertility Care”. Human Reproduction, 29(4), 712-719
- Denson, V.(2006) “Diagnosis and Management of Infertility”. Journal of Nurse Practice, 1, 380-386.
- Empel, W.H; Dancet, A.F; Koolman, H.E; Nelen, L.D.M; Stolk, E.A; Sermeus, W; D’Hooghe, T&Kremer, J.A.M.(2011) “Physicians Underestimate the Importance of Patient-Centredness to Patients: A Discrete Choice Experiment in Fertility Care”. Human Reproduction, 26(3), 584-593.
- Gameiro, S; Boivin, J; Peronace, L&Verhaak, C.M.(2012) “Why Do Patients Discontinue Fertility Treatment? A Systematic Review of Reasons and Predictors of Discontinuation in Fertility Treatment”. Human Reproduction Update, 0(0), 1-18.
- Gegez, A.E.(2014) “Pazarlama Araştırmaları”. Beta Yayıncılık, 4. Baskı, İstanbul.
- Gözüm, S&Aksayan, S.(2003) “Kültürlerarası Ölçek Uyarlaması İçin Rehber II: Psikometrik Özellikler ve Kültürlerarası Karşılaştırma”. Hemşirelikte Araştırma ve Geliştirme Dergisi, 1, 3-14.
- Ho, K. (2006)“The Welfare Effects of Restricted Hospital Choice in the US Medical Care Market”. Journal of Applied Econometrics, 21(7), 1039-1079.
- Jannati, A; Bahrami, M.A; Gholizadeh, M; Alizadeh, L&Khodayari, M.T.(2013) “A Survey of Factors Affecting Patients’ Decision in Selecting

- Governmental and Private Hospitals in Tabriz, Iran”. *Journal of Tourism Research and Hospitality*, 2(1), 1-4.
- Karkee, R; Lee, A.H; Binns, C.W.(2013) “Bypassing Birth Centres for Childbirth: An Analysis of Data from a Community-Based Prospective Cohort Study in Nepal”. *Health Policy and Planning*, 30, 1-7.
- Yanikkerem, E; Kavlak, O&Sevil, Ü.(2008) “İnfertil Çiftlerin Yaşadıkları Sorunlar ve Hemşirelik Yaklaşımı”. *Atatürk Üniversitesi Hemşirelik Yüksekokulu Dergisi*, 11(4), 112-121.
- Kılınç, C.Ç. (2009)“Sağlık Sektöründe Faaliyette Bulunan Hastane İşletmelerinde Müşteri İlişkileri Yönetimi Üzerine Bir Araştırma”. *Review of Social and Business Studies*, 9(10), 309-332.
- Lass, A&Brinsden, P.(2001) “How Do Patients Choose Private In Vitro Fertilization Treatment? A Customer Survey in a Tertiary Fertility Center in the United Kingdom”. *Fertility and Sterility*, 75(5), 893-897.
- Lee, W.I; Shih, B.Y; Chung, Y.S.(2008) “The Exploration of Consumers’ Behavior in Choosing Hospital by the Application of Neural Network”. *Expert System with Applications*, 34, 806-816.
- Leister, J;&Stausberg, J. (2007)“Why Do Patients Select a Hospital? A Conjoint Analysis in Two German Hospitals.”. *Journal of Hospital Marketing and Public Relations*, 17(2), 13-31.
- Loh, A.Z.H; Tan, J.S.Y; Jinxuan, T; Lyn, T.Y; Krishna, L.K.R&Goh, C.R. (2015)“Place of Care at end of Life: What Factors are Associated with Patients’ and Their Family Members’ Preferences?”. *American Journal of Hospice and Palliative Medicine*, 1-9.
- Marcus, H; Marcus, D; Marcus, S.(2005), “How Do Infertile Couples Choose Their IVF Centers? An Internet-Based Survey”. *Fertility and Sterility*, 83(3), 779-781.
- McDowell, S; Murray, A.(2011) “Barriers to Continuing In Vitro Fertilization-Why Do Patients Exit Fertility Treatment?”*Australian and New Zealand Journal of Obstetrics and Gynaecology*, 51, 84-90.
- Mosher ,W.D; Pratt, W.F.(1991) “Fecundity And Infertility in The United States: Incidence and Trends”. *Fertility and Sterility*, 56, 192.
- Özdemir, E; Kılıç, S; Aydın, Z.B.(2010), “Sosyal Güvenlik Reformu Sonrası Tüketici Olarak Hastaların Hastane Seçimi: Pazarlama Açısından Bir Alan Araştırması”. *Uludağ Üniversitesi İktisadi ve İdari Bilimler Fakültesi Dergisi*, 29(1), 1-27.
- Özkoç, H.(2013), “Hastaların Sağlık Kurum Tercihlerini Etkileyen Faktörlerin Belirlenmesi: Uygunluk Analizi ve Nested Logit Model”. *Dokuz Eylül Üniversitesi Sosyal Bilimler Enstitüsü Dergisi*, 15(2), 267-279.
- Öztürk, Y.E.(2014)“Sağlıkta Algılanan Kalite ve Hastane Tercih Nedenlerinin İncelenmesi”. *Gümüşhane Üniversitesi Sağlık Bilimleri Fakültesi Dergisi*, 3(4), 1079-1094.

- Pedro, J; Canavarro, M.C; Boivin, J&Gameiro, S.(2013) "Positive Experiences of Patient-Centred Care are Associated with Intentions to Comply with Fertility Treatment: Finding from the Validation of the Portuguese Version of the PCQ-Infertility Tool". *Human Reproduction*, 28(9), 2462-2472.
- Peddie, V.L; Teijlingen, E.V&Bhattacharya, S.(2005)"A Qualitative Study of Women's Decision-Making at the end of IVF Treatment". *Human Reproduction*, 20(7), 1944-1951.
- Phibbs, C.S; Mark, D.H; Luft, H.S.; Peltzman-Rennie, D.J; Garnick, D.W; Lichtenberg, E&McPhee, S.J.(1993)"Choice of Hospital for Delivery: A Comparison of High-Risk and Low-Risk Women". *Health Services Research*, 28(2), 201-222.
- Rajkhowa, M; McConnell, A&Thomas, G.E.(2006) "Reasons for Discontinuation of IVF Treatment: A Questionnaire Study". *Human Reproduction*, 21(2), 358-363.
- Ringard, A&Hagen, T.P.(2011) "Are Waiting Times for Hospital Admissions Affected by Patients' Choices and Mobility?". *BMC Health Services Research*, 11(170), 1-9.
- Sourter, V.L; Penney, G; Hopton, J.L&Templeton, A.A.(1998)"Patient Satisfaction with the Management of Infertility". *Human Reproduction*, 13(7), 1831-1836.
- Taşlıyan, M; Gök, S.(2012)"Kamu ve Özel Hastanelerde Hasta Memnuniyeti: Kahramanmaraş'ta Bir Alan Çalışması". *Kahramanmaraş Sütçü İmam Üniversitesi İktisadi ve İdari Bilimler Dergisi*,2(1), 69-94.
- Tai, W-T.C; Porell, F.W&Adams, E.K.(2004) "Hospital Choice of Rural Medicare Beneficiaries: Patient, Hospital, Hospital Attributes and the Patient-Physician Relationship". *Health Service Research*, 39(6), 1903-1920.
- Tengilimoğlu, D.(2001) "Hastane Seçiminde Etkili Olan Faktörler: Bir Alan Uygulaması". *Gazi Üniversitesi İktisadi ve İdari Bilimler Fakültesi Dergisi*, 1, 85-98.
- Tengilimoğlu, D; Yeşiltaş, M; Kısa, A&Dziegielewski, S.F.(2008) "The Role of Public Relations Activities in Hospital Choice". *Health Marketing Quarterly*, 24(3), 19-31.
- Vayena E, Rowe P, Griffin P.(2002)"Current Practices and Controversies in Assisted Reproduction". Report of a Meeting on Medical, Ethical and Social Aspects of Assisted Reproduction Held at WHO Headquarters.

ADVANCING GENDER EQUALITY IN SIERRA LEONE'S LAND SECTOR

Tegan Joseph Mosugu

New York University, MPA/M.S. Global Affairs Dual-Degree Candidate

Abstract

Africa has not been immune of land rights violations. Throughout Africa, the right to use and access land has been obstructed from marginalized communities. Women are the victims of this harsh reality and efforts to address this on a universal level has been futile. As an independent researcher, I conducted a deep-analysis of the literature in order to understand the adaptive challenge of gender equality and the infringement of women's rights when it comes to land access and use in Sierra Leone. Using an adaptive analysis framework, I was able to comprehend the systemic inequalities and complexities in the land sector, as a result, I was well equipped to provide real-time recommendations for organizations on the ground such as Transparency International. These recommendations provided actors and stakeholders with a set of practical tools so as to be better equipped in their gender empowerment and risk assessment work.

Keywords: Rights, Gender Equality, Women, Land

Introduction / Problem Statement:

“For many years, activists have campaigned for women's rights to access, control, and, where context allows, own land. This is in recognition of the fact that land is important not only for growing food or as a place to build a home. Land is also a resource that can be used to generate other forms of livelihoods, a place to belong to, and an identity.”⁷ In Sierra Leone, 80% of people working in the agricultural sector are women⁸. However, there are so many challenges that they encounter when it comes to land use.

⁷ “From Marginalization to Empowerment: The potential of land rights to contribute to gender equality – observations from Guatemala, India and Sierra Leone.” ActionAid. http://www.actionaid.org/sites/files/actionaid/from_marginalisation_to_empowerment_-_land_rights_and_women.pdf

⁸ *Sierra Leone's Women Face Land Rights Challenges*. http://www.voanews.com/content/sierra_leone_women_face_land_rights_challenges/1621710.html. Voice of America. February 19, 2013.

Land rights is a pivotal tool that can contribute to gender equality in Sierra Leone. In fact, when women have secured land rights, they are able to maintain a standard of living and in the long-run take their families out of poverty.

In Sierra Leone, 83% of the owned land is that of the family⁹. The systematic complexities such as the oldest male holding land trust or a chief being the holder of communal land, makes it arduous for women to climb up the echelon of land ownership/tenure. Lower class of individuals such as women are unable to have equal access to land. In cases in which they ideally should, they have their land rights stripped away as a result of the politics and bureaucracy that occurs in the nation. This memorandum seeks to provide a set of recommendations to non-governmental organizations on the ground in order to mitigate gender inequality risks associated with the land sector.

I. Women in Legislation

In 2009, The Committee on the Elimination of all forms of Discrimination Against Women (CEDAW) conducted a report that revealed that “63% of women in urban areas and 84% of women in rural sectors are engaged in the informal sector, hampered from reaching their potential by poor and unequal access to land (based on customary practices), skills training, appropriate technology, functional literacy, and information on markets and finance.”¹⁰ Just like many other countries, there is a disproportionate number of women in Sierra Leone’s parliament. In Sierra Leone, “women make up 52 percent of Sierra Leoneans, yet occupy less than 20 percent of elected positions.” Hence, it is important to have an active women’s presence in decision-making¹¹.

Recommendation I

In order to promote gender equality in the land sector, non-profits should partner with other women’s rights organizations and political associations that are currently working to pass a gender equality portion of

⁹ “*From Marginalization to Empowerment: The potential of land rights to contribute to gender equality – observations from Guatemala, India and Sierra Leone.*” ActionAid. http://www.actionaid.org/sites/files/actionaid/from_marginalisation_to_empowerment_-_land_rights_and_women.pdf

¹⁰ Perrault F, Baldeh Y, Wahome J, Zayid J. “*Sierra Leone, Country Strategy Power 2013-2017.*” http://www.afdb.org/fileadmin/uploads/afdb/Documents/Project-and-Operations/2013-2017%20-%20Sierra%20Leone%20Country%20Strategy%20Paper_01.pdf African Development Bank Group. August 2013.

¹¹ “*Sierra Leone*” The National Democratic Institute. <https://www.ndi.org/sierra-leone>

the government's Agenda for Prosperity (A4P) bill. This affirmative action bill will allocate at least 30% of parliamentary seats to women¹². Having this bill signed into law is pivotal when it comes to making long term systematic change.

According to The Foreign Affairs Minister, his honorable Samura Kamara having more women appointed to topmost public decision positions "provides a clearer national framework and road map for the government and stakeholders on women's rights and their advancement thereof."¹³ Organizations such as *Human Rights Watch and Transparency International* should actively frame its gender equality goals utilizing "*The National Policy on the Advancement of Women and the National Policy on Gender Mainstreaming*" as it partners with other women's rights organizations and political associations that are geared towards advancing women's empowerment¹⁴. By using this framework, these actors are clearly pointing out to stakeholders that gender equality is mainstreamed in most of the policies, plans and legislations; however, it needs to be mainstreamed in the country's land sector.

National Women's Commission

Presently, there are not any institutions or processes set in place for women to galvanize collectively when it comes to land rights and land tenure. ActionAid sampled 58 women to gauge them on their sentiments towards public forums¹⁵. Only sixteen of those surveyed felt that they had something substantial to contribute to these forums. In fact, the vast majority of them lacked the sense of empowerment that comes through collective action. If Sierra Leone is going to make strides in gender equality when it comes to land use and access, it is imperative that everyone sees the

¹² Perrault F, Baldeh Y, Wahome J, Zayid J. "*Sierra Leone, Country Strategy Power 2013-2017*" http://www.afdb.org/fileadmin/uploads/afdb/Documents/Project-and-Operations/2013-2017%20-%20Sierra%20Leone%20Country%20Strategy%20Paper_01.pdf African Development Bank Group. August 2013.

¹³ *Sierra Leone's Women Face Land Rights Challenges*. http://www.voanews.com/content/sierra_leone_women_face_land_rights_challenges/1621710.html. Voice of America. February 19, 2013.

¹⁴ "*Status of Gender Mainstreaming in Sierra Leone*." Ministry of Social Welfare, Gender and Children's Affairs. http://www.ecreee.org/sites/default/files/documents/news/status_of_gender_mainstreaming_in_sierra_leone_0.pdf

¹⁵ "*From Marginalization to Empowerment: The potential of land rights to contribute to gender equality – observations from Guatemala, India and Sierra Leone*." ActionAid. http://www.actionaid.org/sites/files/actionaid/from_marginalisation_to_empowerment_-_land_rights_and_women.pdf

importance of working together, and it starts from the highly-educated woman as well as the woman struggling to make ends meet for her family.

Recommendation II

The United Nations has advised the government of Sierra Leone to set up a National Women's Commission as a way of achieving the Millennium Development Goal #3. The boards of various governmental and non-governmental organizations in Sierra Leone need to utilize its contacts and networks in The Ministry of Social Welfare, Gender and Children's Affairs. There is a need for a National Women's Commission in Sierra Leone especially when it comes to promoting gender equality. "In situations where women can own and control land, such as where one can buy the land from the land market, women are constrained by several socio-economic factors, such as illiteracy, lack of capital and implements, lack of collateral, lack of farm management experience, training and advice."¹⁶

Having such a commission set in place serves as a centripetal tool when it comes to galvanizing women of all classes. This is because when there are institutions that exist and allow change to permeate, the vast majority of women are more than likely going to take advantage of the resources at their disposal. TI should actively work with the Ministry when it comes to creating this Commission. A National Women's Commission would further the gender empowerment cause since women in both urban and rural areas would be empowered to not only speak up, but to drive change in their municipalities and local towns/cities. However, as these non-state actors lobby for the establishment of this Commission, it must work to ensure that a division to investigate to Gender Inequality & Land Issues is created. Having this component would serve as a system of checks and balances to not only curb down the rate of corruption on both a micro and macro scale, but also monitor other irregularities and discriminatory activities going on in the system.

"Rural land is generally abundant, and availability of land is not considered a constraint in agricultural production. However, locally powerful families and chiefs often control access to the highly valued wetlands and inland valley swamps that permit intensive, year-round production, and less powerful members of rural communities, including women, may not have equal opportunities to access productive land. In the capital of Freetown and its environs (called the "Western Area"), much of the land is privately held in freehold tenure."¹⁷

¹⁶ G. Mutangadura. "Achieving gender equality, women's empowerment and ending violence against women in Africa: A review of the role of family policy and social protection." <http://undesadspd.org/LinkClick.aspx?fileticket=mmmM6gFDxYlw%3D&tabid=215>

¹⁷ USAID: Property Rights and Land Governance: Sierra Leone.

Thus, there needs to be a system or institution set in place that serves as a system of checks and balances when it comes to different stakeholders involved in land access and rights. If this is in place, less powerful members of rural communities would be able to have equal opportunities to access productive land.

Women and Mining: Sierra Rutile Mining Area

*“In Sierra Leone, women in the Sierra Rutile mining area have been forced to cultivate upland areas with less productive soils because of mining-linked dispossessions. Two affected districts, Bonthe and Moyamba, are among the five poorest districts in the country, with the loss of livelihoods due to resource theft and environmental degradation caused by rutile and bauxite mining identified as the most significant contributor to chronic poverty and food insecurity.”*¹⁸

Securing gender equality also implies enabling women to have access to the most fertile lands. In an ideal world, women should not be forced to cultivate in less fertile lands. Unfortunately, that is the case in the Sierra Rutile mining area of Sierra Leone. An in-depth investigation into companies that operate in that region shows that 11 villages that were displaced by these multinationals were “resettled in farmlands reported to be grossly inadequate.”¹⁹

The actions of various corporations and multinationals in Sierra Leone’s mining sector not only detrimental to women’s rights but also to a plethora of other development goals. For example, practices such as those occurring in the Sierra Rutile area of Sierra Leone do not only increase the level of poverty for families, but they also promote negative social ideologies such as not sending your girl child to school and other forms of exploitation.

Recommendation III

Transparency International and Adam Smith International Partnership

In an attempt to reduce the risks associated with the mining sector, *Transparency International* must join forces with other watch dog groups immersed in this adaptive challenge. *Adam Smith International* is actively immersed in Sierra Leone when it comes to establishing a regulatory

http://usaidlandtenure.net/sites/default/files/country-profiles/full-reports/USAID_Land_Tenure_Sierra_Leone_Profile.pdf

¹⁸ Akiwumi F.A, “*Transnational mining corporations and sustainable resource-based livelihoods in Sierra Leone*”, *Singapore Journal of Tropical Geography*, 32:1, 2011, pp. 53–70

¹⁹ Mboka L, “*Chronicle of corporate exploitation: The Sierra Rutile experience*”, *Mines and Communities*, 15 September 2003, www.minesandcommunities.org/article.php?a=3732

framework for artisanal mining in the country²⁰. Currently, this free-economy based group, is implementing a set of regulations that are aimed at protecting the rights of workers and the environment.

In 2009, the government of Sierra Leone passed the Mines and Minerals Act. This law entrusts all ownership and control of mines in the hands of the state²¹. However, enforcing this act has been an arduous task. From 2010-2011, *Adam Smith International* sought to achieved two major objectives in its work in the mining sector²²:

- i. Drafted mining Social and Environmental Regulations
- ii. Drafted mining technical Operational Regulations, including health and safety provisions
- iii. Developed a Resettlement Policy Framework

Despite their tremendous achievements, there are still unjust and inhumane occurrences in The *Sierra Rutile* mining area and a plethora of other places. These events are not only detrimental to women, but they pose a huge risk to the development and well-being of mining communities. TI must undoubtedly collaborate with *Adam Smith International*, so as to effectively reduce mining sector risks, but also promote gender equality on the long-run. This partnership should also involve working alongside the federal government when it comes to making sure that women have equal access to land, and that other health and environment hazards can be put in check/monitored. Most importantly, it is important that the mining companies and other stakeholders are able to reach a compromise when it comes to reducing the risks associated with the mining sector while attracting international investment.

Resisting Change on the Micro Level.

The customary laws in Sierra Leone make it hard for lower class women to own land. This is because if one is not a part of a well-established family, her chances of owning or even investing in land is diminished. For those that even are a part of privileged families, land ownership is not even guaranteed.

²⁰ Adam Smith International. "Establishing a regulatory framework for artisanal mining in Sierra Leone." <http://www.adamsmithinternational.com/explore-our-work/west-africa/sierra-leone/establishing-a-regulatory-framework-for-artisanal-mining-in-sierra-leone>

²¹ Viruet-Soto Yadira. "The Mineral Industry of Sierra Leone." <http://minerals.usgs.gov/minerals/pubs/country/2010/myb3-2010-sl.pdf>

²² The Guardian. "Legislative, institutional and economic reform of Sierra Leone's mining sector." <http://www.theguardian.com/global-development-professionals-network/adam-smith-international-partner-zone/legislative-institutional-economic-reform-sierra-leone-mining-sector>

“In 2007, the Devolution of Estate Act made it illegal to prevent a woman from inheriting a husband’s property after his death and recognized the rights of polygamous spouses, but as the Act only applies to an individual’s right to land and not a family’s right to land it has not been recognized by Paramount Chiefs and has been overruled by customary law in many areas, according to anecdotal reports.”²³

Thus, even when the law changes, paramount chiefs and other local authorities take decisions into their own hands based on what they deem best. Whether it is nepotism or corruption, paramount chiefs are not seeking to honor the supreme law of the land. In many cases, rural and urban women are uneducated about their rights when it comes to owning a piece of land or property that is rightfully theirs.

Recommendation IV

It is recommended that research groups in both academia and government come together to conduct a case-study or perform a set of interviews with women in The Limba Tribe of Sierra Leone²⁴. An evidence-on-demand study revealed that these women in the North have land ownership and land access rights. Within that same study, the authors also highlighted that a woman has a higher chance of owning land or property, if she is situated in The Western Region of the country²⁵. *Organizations that have the capacity to*, should conduct a case-study or have interviews with women in these localities. Doing so, would enable TI to have an idea on how these women achieved this milestone and what was done to improve the gender equality atmosphere in those areas, in terms of land access and use.

Recommendation V

Last but not the least, all actors should work with The Ministry of Lands, Country Planning and Environment when it comes to educating paramount chiefs and raising public awareness about land rights for women.

²³ IRIN (2012) Sierra Leone: Fighting for women’s right to land, 22 June 2012, IRIN. Available at: <http://www.irinnews.org/report/95705/sierra-leone-fighting-for-women-s-right-to-land> [Accessed 2 February 2015]

²⁴ USAID (2010) USAID Country Profile Property Rights and Resource Governance, Sierra Leone. Available at: http://usaidlandtenure.net/sites/default/files/country-profiles/fullReports/USAID_Land_Tenure_Sierra_Leone_Profile.pdf [Accessed 2 February 2015].

²⁵ Williams, S. and Oredola-Davies, P. (2006) ‘*Land and pro-poor change in Sierra Leone: Scoping Study*’, prepared for joint EU-DFID Country Assistance Plan for Sierra Leone, July 2006. Available at: <http://www.britishcouncil.org/land-and-pro-poor-change-in-sierra-leone.pdf> [Accessed 2 February 2015]

Working with the ministry would help bridge the gap between theory and practice when it comes to honoring The Devolution of Estate Act.

Conclusion:

Gender equality and land rights are hand-in-hand when it comes to empowering our young women, but also in terms of alleviating poverty for several households in Sierra Leone. Land rights for women are a pivotal tool that can bring social and economic change in Sierra Leone. As a result, this topic should not be taken for granted. The recommendations provided above would hopefully serve as a starting point for ensuring that a laissez-faire approach is not taken by the government when it comes to land crisis.

CHALLENGES OF TERTIARY EDUCATION IN LIBERIA AND POSSIBLE SOLUTIONS

Mory D.A Sumaworo, B.A in Law, MCL, PhD Candidate in Comparative Laws

Ahmad Ibrahim School of Laws, IIUM, Malaysia
President of the Heritage Schools Union in Liberia

Abstract

Liberia as a post- conflict zone faces lots of challenges, but atop of which is preparing reliable and productive human capital through which abundant natural resources that it has can be beneficial and help to change its status of underdevelopment. Further, among negative aftermaths of the 14 years of Civil Wars (1989-2003) in Liberia, is massive migration of professionals and qualified teachers and universities lecturers to the western world mainly the United States of America. Thus, this migration left an adverse effect on pre-university studies in Liberia. As a result, tertiary education has been also dangerously affected. Despite the international and national efforts to revive and rejuvenate educational sector in Liberia, the situation seems to be facing multiple challenges, especially the higher education. Besides, the weakness in Liberian education system has led the President herself, a Noble Price laureate, her Excellency Madam Ellen Johnson Serleaf to describe Liberia education as a mess. Moreover, poor implementation of educational policies, ill - financial supports for institutions of higher learning, poor educational infrastructures, and rampant child labour etc., are some of major things that constitute challenges to higher education in Liberia. Nonetheless, there have been lots of attempts and practical endeavors to reform and refine pre-university school system in Liberia. Subsequently, sophisticate tertiary ones for development and building productive human capitals by the government and her local and international partners, such as The United States International Aid (USAID), The World Bank, the International Monetary Fund (IMF), the African Development Bank, A.S Charitable Society, (a local NGO) Catholic Schools, Methodist Schools (local school systems) and others. Therefore, this article aims at looking at challenges facing tertiary education in Liberia and how could they be mitigated and minimized so that the system should be the best after being the mess.

Keywords: Liberia education system, Tertiary education, pre-university, education policy

Introduction

Africa as a whole which Liberia forms a part, has made noticeable progress in educational sector since last decade, yet there are still many challenges to be handled and mitigated as observed by the UNISCO (United Nation Educational, Scientific and Cultural Organization) in its World Conference on higher education in 1998 (Goolam, 2011)

Meanwhile, sound higher education is a gateway of developing sound and productive human resources for any given nation. If any loophole happens to be found in tertiary education system that will definitely lead to adverse effects on the nation's productivity as a result its economy will negatively be affected. This is a scenario in many African countries, and more specifically the Republic of Liberia, which had endured 14 years of Civil Wars (1989-2003) that ruined its infrastructures including educational ones. Furthermore, while this tiny West African nation trying to reform all its sectors especially education, the Ebola Virus hit the country and set as one of its biggest challenges. Further, in 2013, 25000 students sat for entrance exam to the University of Liberia the biggest state –run university, but sadly it was declared that none of them passed in the test due to their poor performances as the spokesman -Momodou Gataweh- of the University told BBC Focus on Africa “In English, the mechanics of the language, they didn't know anything about it. So the government has to do something” (BBC Africa 2013) while Minister of Education Mrs. Etmonia David-Tarpeh acknowledges the setback in Liberia education system but raises a doubt about the possibility for whole group to fail the test. Mrs. David-Tarpeh said, “I know there are a lot of weaknesses in the schools but for a whole group of people to take exams and every single one of them to fail, I have my doubts about that” ((BBC Africa 2013). What this argument between the State own university and the Ministry of Education suggests is, there is a problem in the pre-university education in the country, which outcome leads to this massive failure of students in the entrance exam for university enrollment.

Besides, the reason behind this might be unavailability of vacant seats at the State own University, which implies involvement of private sector to save the nation from its education crisis. Because if there are lots of private universities, and higher institutions of learning, the burden on public university will drastically reduce and rate of student enrollment will certainly increase. The problem happened because for a long time we were happy with the public, government-owned system (Singh, 2013) . Another set of

challenges facing higher education in Liberia characterized in poor infrastructures especially for science related disciplines. For instance, lack of well –equipped and sophisticated science laboratories. Thus, this has made most of the students to prefer non- science colleges as a result qualified science students are hardly found in the country.

Significance of Higher Education for Liberia post-war development

In order to really understand the gravity of damage tertiary education suffers when it is not on the right course, it is crucial to outline some significance that higher education has on development of any country and more specifically in fragile states like Liberia. Higher education is a driven tool to sound economic stability, sustainable peace, social development, scientific innovation and technological advancement (**Yizengaw**, 2008). All these are highly needed and demanded in Liberia as strategies to make her graduate from its current economic, social, and security situations to what is anticipated by all well-meaning Liberians, the International Community and other development partners.

Thus, quality higher education will certainly attract Foreign Direct Investors (FDI) flow in the country with their huge capitals and massive career opportunities as they would be less reliant on bringing with them expatriates which costs companies lots of money some time in foreign country. Therefore, below are some important benefits of higher education:

Economic benefit

This aspect of higher education can be seen in different angles; it can increase employment opportunities, facilitate salary increment; bring about greater productivity and national development in all domains (**Yizengaw**, 2008). The economic benefit of tertiary education in Liberia is nowadays vividly seen as some multinational company might want to employ Liberians at key positions with luxurious salary, but because of lack of qualified Liberian, the job might likely go to non-Liberian. I had the meeting with the Director of Dispute Settlement at the Ministry of Labour Mr. Nathaniel Dickerson, he told me during our discussion that a company approached them for assistance of having a Liberia geologist to occupy a post , but unfortunately they were not able to meet qualified target, thus job went to non-Liberia with all its benefits.

Social and Political Benefits

Higher education gives greater chance to the people to improve their lives the lives of their families as it secures job opportunity for them and furnish them with brilliant ideals to create jobs for others by establishing new businesses and institutions. Politically on the other hand, tertiary education

sophisticates the public with analytical tools to promote the rule of law, democracy, good governance, and oversight responsibility on public offices.

“Higher education enhances the political context by contributing to building civil society, enlightened citizenship, self-reliance, equal opportunity and skills and values of argumentative dialogue and reasoning, tolerance and respect (4). It facilitates national development by promoting democratic ideals, as well as intellectual and industrial competitiveness; by promoting greater social cohesion, peace, trust in social institutions, democratic participation, and appreciation of diversity in gender, ethnicity, religion and social class (6). It also improves the accountability of governments and generates independent research and analysis that supports the vibrant debate that can greatly improve the effectiveness of government policy and other services” (Yizengaw, 2008).

Human Capital and Professional Development

It is an undisputable fact that any country with high quality of tertiary education, professionalism and reliability on its human capital for national development and encouraging investors to do business with that country can be highly sought. Further, with sound and quality higher education the nation can secure and have well - qualified medical doctors, engineers, politicians, economists, and critical thinkers. Obviously, all these are very important components in driving any development agenda, economic recovery, and socio-political reforms. Besides, capacity building in Liberia is one of the government priorities as the nation still striving to produce engineers, medical doctors, and other science oriented experts; this is due to the fact that the tertiary education has been over the years dominated by students of art colleges because of poor equipment and facility needed in science colleges.

Scientific benefit

Institutes of higher learning are not only designed for traditional teaching by delivering lectures to students. Rather, they are the sources of technological innovations and creativity in science and other disciplines. Thus, those innovations and researches are of utmost importance in solving lots of problems in the country and in the world at large.

Support other levels of education

Pre-university study is very crucial; it largely depends on dividends of tertiary institutions. With reliable higher education other levels of education could be sustained and thus significantly produce qualified

students for higher study and job market as well. In other words, secondary schools are in most often managed and taught by those with university degrees. However, in Liberia context, the scenario is quite different as most of the secondary and high schools are being taught by those with the same qualifications (High school Diplomas). At the university level, majority of lecturers at most of the tertiary institutions in Liberia are university degree holders. So, in this kind of situation large percentage of universities products would definitely be substandard as a result other levels of education can be affected.

Challenges of Higher education in Liberia

Admittedly, Liberia is not far different from most of its counterparts in the African continent in terms of having faced multiple challenges of tertiary institutions, notwithstanding massive educational reform all over the world that are premised on the assumption that such reforms are good and could lead to an improvement in educational practices and process. Subsequently, produces better citizens, yet history shows clearly the political and economic nature of the forces that lead to stampede in reforms in many African countries such as Liberia (Adamu n.a). Thus, this is happening because of existence of some setbacks in higher educational system, they could be social, financial, academic, political and other factors like security condition especially when Liberia engaged in 14 years of Civil Wars that badly affected school- going children and crippled parents and teachers alike. However, this aspect of the article will look at some of these challenges in detail as discussed below:

Governance and leadership Challenge:

Higher institutes of learning are just like states by themselves, they can be better places to live had they being managed properly and led professionally. This does not necessary mean that those who are in the leadership positions have no requisite qualifications, rather it means applying sound educational and managerial skills to promote and maximize quality of the universities products (students). Further, most of Liberian tertiary institutes including the University of Liberia – the State - owned University- are being run by substandard manner which always fuel tensions between central administrations and faculty members on one hand and between the central administration and students on the other hand. Besides, these tensions can some time lead the university to be closed and classes to be suspended for months while their counterparts in the region and the rest of the world are striving to be high ranked universities in the world.

Moreover, another related factor to this challenge in Liberia's universities and colleges is lack of innovation in leadership. That is; most of

decision making personals have been in the system for years as a result they always prefer running institutions the way they were managed thirty or more years back.

Lack of sufficient funding

Running a tertiary education requires sufficient funding and proper financial support in order to meet day- to- day targets and the overall objectives of the institution, atop which is producing quality and qualified students for the job market and national development. Further, proper funding for the higher educational institutions is a driving force for any highly dependable, reliable, and sophisticated scientific research in different disciplines. Nevertheless, when financial support for universities - either because the tuition that students pay is not enough to administer their affairs or the subsidy that they receive from the government or other partners cannot help them achieve the target – is so weak and insufficient then the overall objectives of the institutions will definitely be affected.

Besides, this is the case in Liberia universities and colleges as they struggle to compete with other universities in the world because of financial constrain which lead to poor performance of professors and students. In other words, most of professors in Liberia universities have multiple assignments and jobs with different institutions in order to meet their financial needs and wants, so their full commitment and dedication to universities and colleges can be comprised. I meet couple of universities students and asked about some challenges they face from their lecturer and professors, they answer of almost 75% was “We do have lots of highly competent lecturers and professors, but most them are working with other government agencies and NGOs, as a result of that they can assign some of their former students whom to them are capable to lecture on their behalf. Nevertheless, that is not the case because those former students don’t have even Master’s degree some of them even stay doing their first degree”

Shortage of faculty member

Students and faculty members are major components of any tertiary institution; the ratio between these two groups has to be well-balanced according to the best international standard----- referece). However, in the case of shortage of faculty member, there would be unreasonable crowdedness and congestion which – without a slightest doubt – could have a negative impact on the output of lectures and cripple the institution to reach its core targets and achieve its aims and objectives. Moreover, in Liberia context, the University of Liberia and other institutes of higher learning face this challenge.

Evidently, in the University of Liberia, some normal class room

accommodates more than 100 students at once with no adequate facilities like microphone or projectors. Just recently, in order to mitigate this problem, the University's administration decided to divide students into two groups; senior students have a month, then junior ones have another. However, with all these efforts and strategies the problem and challenges still exist.

Lack of research and innovation

Among the major objectives of any well-furnished tertiary institutions is to conduct research to solve existing problem or prevent the potential ones. Also, scientific innovation is of major concern of highly sophisticated universities and colleges in the world. However, in Liberian context, universities and colleges are still facing strong challenge for academic research and scientific innovations, there no ISI journals in the entire Republic, and lecturers are not so active in publishing articles; because of lack of proper founding for research in the universities. Further, because of lack of science laboratories and modern technology equipment in the tertiary institutions, the innovation is still unborn in Liberia.

Poor university infrastructure

Having said that academic outputs and scientific and technological innovations are among core aims for which tertiary institutions can be established, this can be a mere theory if it is not coupled with physical educational infrastructures. For example, well-equipped libraries and laboratories with decent and encouraging study environment.

Nevertheless, Liberia higher education lacks almost of these requisites of quality production of qualified scientist and internationally reliable academicians in various disciplines. However, the blame does go to the entire system, never to those who found themselves in academia, because no matter how professor or lecturer is smart and courageous if the institution's facilities are not encouraging his/her output will not be compared with those who have them. I did interview with Mr. J. Agostinho Bioh, Law School's Library assistant at the University of Liberia and also post-graduate student with the same university. He said "major challenge we face here is lack of libraries and laboratories"

Poor performance of high school' students

It is obvious whether in Liberia or elsewhere for the higher institutes of learning to struggle and face challenges if prospective students at pre-tertiary institutions are academically impaired. This always causes universities and colleges to put extra effort to do what had to be done at high schools as a result it would affect other major target of the university.

Undeniably, this is the case in large of percentage of high schools graduates in Liberia as their performance in basic subjects such as Math, English, Chemistry and Physics is not satisfactory. Therefore, they admit to the universities which curriculum does not observe this challenge, the product (college graduates) can be very poor in job market, above that it gives serious problem to the university's administration because some student with poor performance may exceed regular time framework before they graduate occupying space for other students to enroll. Besides, the Minister of Education himself has admitted this fact in his recent show with **Truth Break Fast Show** (TBS) with the Truth Radio 95.1 when he said that there is a poor outcome of our high school but there are also solutions to that. For instance, providing textbooks to students and training teachers with science and math etc. (TBS 09/06/2015)

Centralization of higher education (Morovianization of the University Studies)

Almost 90% of universities and colleges are based in Monrovia the capital city of Liberia. Though, recent development has shown opening some community colleges in other counties. But because of most of major activities especially commercial and administrative one have been centralized in Monrovia, students rarely prefer enrolling into those community colleges and Tubman University in Maryland (The second public university in Liberia). Thus, this causes serious problem for universities and colleges in Monrovia in terms of congestion and overcrowdings in lectures' halls at the universities and colleges. Consequently, the study environment is unfriendly and students and lecturers outputs can be seriously affected.

Medical challenge

is pertinent to include medical as one of challenges that face tertiary education in Liberia. For instance, the Ebola virus outbreak has affected Liberia education as whole and university study in particular. The outbreak of virus led universities and colleges to be closed for almost two consecutive semesters which – no doubt – jeopardized the whole system. Even after Liberia declared by the WHO Ebola free the stigma and negative aftermath remain on schools and universities in terms because of poor attendance and other curricular activities.

Possible solution

Having admitted that there are challenges in Liberia higher education that do not dismiss the fact that they can't be handled or sorted out. Besides, with sound and implantable policies by the government and other development partners to reform and refine higher education in Liberia, most

of those challenges would be diminished. Thus, transformation premised on the best international practice would be achieved.

Drafting sound education reform policies

Governing educational institutions requires good policies that serve as a vehicle to reform and transform educational system from what it is to the better one. Liberian government has a quite number of policies and regulations related to education; however they have relatively been able to handle some problems. Nevertheless, there are still lots of challenges standing needed to be addressed by relevant policies that suit them. For instance, decentralization policy of higher education, capacity building project for lecturers to pursue their Master and Ph.D. in some high profile university in the United States, Europe, Asia, Canada, Japan etc. It is not always about physical cash, rather sound reform and effective cooperation between government and its partners. Further, this has been emphasized by the newly appointed Minister of Education Mr. George Werner when he stated when he appeared on TBS (Truth Break Fast Show) “Education reform is not just about money, but we need careful analysis and cooperation between government and people” (TBS, 9/06/2015)

Comprehensive and Market –Oriented Curriculum

Another strategy to minimize challenges that facing tertiary education in Liberia is to design study plans and curriculum that works alongside with modern reality and market. However, this will give strong background to the pre-university’ students before their enrollment into tertiary institutions. In other worlds, the curriculum in this context does not mean theoretical study structure on paper, rather it insinuates practical aspects, such as, establishing public private libraries and laboratories for practical training to be rendered for high school students. Further, this will change the trend of large percentage of students being admired and admitted into art causes over science colleges despite the nation in dire need of science college graduates to achieving its development agenda.

Also, compressive and market - oriented curriculum will gradually put Liberian universities on the list of top innovative university in Africa and the rest of the world as it will encourage faculty members to engage in scientific research and innovation for solving multiple problems; medical and technological problems in Liberia, Africa and our global village.

Sufficient Budget for Education

Education in general and higher education in particular requires sufficient financial supports to run its affairs; administration, research and innovation, upgrading facilities and infrastructures, social services and

others. All these are matter of money with strong commitment. However, most of universities in developing world in Africa including Liberia are in lack of adequate funding to meet the above stated targets. Thus, that creates and gives birth to multiple challenges associated with effectiveness of higher institutes of learning in Liberia. For instance, universities that always with outdated facilities, research and innovations will be dangerously crippled if there are no enough funds to update them. So, it is recommended for the Liberian universities and colleges to be adequately funded by the government by allocating budges for all what the institution needs to meet its target not remunerations for the staffs and faculty members alone. On the other hand, the international partners such USAID, UNESCO, the Word Bank, the African Development Bank get to be onboard to tackle this problem by providing financial assistance to colleges and universities as Liberia is now stragglng to invest in different domains with many competing priorities; infrastructure, security, education, etc.

Encouraging Private Sector Involvement in Tertiary Education

Current really suggests that most of the success stories of higher education in the world are indebted to effective public –private partnership in providing quality tertiary education to the people. For instance, in Malaysia “private sector involvement was the leading part of the higher education reforms” (Aishira, 2009) . Therefore, if PPP (public private partnership) is sophisticatedly established thus high profile private colleges and universities are opened either afresh or a branch of any other universities in advanced world especially the United States which is role model of Liberia socio-political and somehow educational system because of longstanding historical tie between the two countries.

Moreover, private sector engagement will increase enrollment rate to tertiary institutions as it would provide extra seats and lessen burden on public universities in Liberia. This strategy has really worked in many countries that were facing challenges that Liberia is now facing as it is evidence in the statement of Pramath Raj Sinha - the founding dean of the Indian School of Business (the youngest and first Indian B-school to break into the Top 20, according to the *Financial Times* Global MBA rankings)-when he was asked about challenges of Indian higher education faces. He said

“The problem happened because for a long time we were happy with the public, government-owned system. Unfortunately, until a few years ago, India was in denial of the situation. While there was a government push to ramp up access in primary and secondary schooling, when it came to higher education, we were too focused on the few good institutions we have, such as the

IITs (Indian Institutes of Technology) and the IIMs (Indian Institutes of Management) (none of which are in the QS Top 200, though” (Singh, 2013)

Proper implementation of higher education policies

Policy implementation is generally held to be the step that follows policy formulation and is viewed as ‘the process of carrying out a basic policy decision.’ (Sabatier & Mazmanian, 1983,p. 143). However in most cases in Africa and in Liberia specifically lots of sound and intelligent educational policies are there, but the problem is lack of proper compliance and application of those policies into reality to meet its intended purposes.

Therefore, it is highly advisable to the government of Liberia to not only design strategies to improve tertiary education rather to have full control and oversight responsibility in order for them to be adequately implemented. Despite the government’s efforts to reduce literacy rate, but it seems not to yield satisfactory result because proper implementation of policies and laws contributing to meet this end. For instance, massive child labour on the streets of Monrovia, the capital city of Liberia is alarming during school’s hours. Therefore, these children will not have access to reading and writing as a result literacy rate will always be increasing.

Besides, Sajid Ali is of the view that “the failure of educational policy in developing countries is largely attributed to the issues of poor implementation” (Ali: 2006 p.5). Evidently, section 1.4 (c) reads that the law should strengthen scientific and technological learning as a basis for speedy industrialization and economic advancement” (Education Law: 2002) Nevertheless, since the passage of this law there have not been any well-equipped and sophisticated libraries and laboratories in the country especially at various universities and colleges. This implies improper implementation of this sound and development driven policy in Liberia.

Establishing strong international academic cooperation

Having recognized some setbacks in Liberia’s higher education institutions and challenges that the products of Liberian universities and colleges facing. Therefore, signing an academic cooperation and MoUs between Liberian institutes and their counterparts in advanced world in Europe, the United States and other parts of the globe would be among the best and efficient solutions to upgrade and standardize level of tertiary education in the country. As by doing so, the nation will be hosting highly qualified lecturers in different disciplines – especially in science and technology - to assist their fellow Liberian lecturers to produce market demanded graduates and development driven scholars.

Conclusion

Higher education is a backbone of sustainable development for any given geographic being. Therefore, in order for Liberia to really sustain what has achieved since its 14-year of Civil Wars ended in 2003 followed by democratic election, priority has to be put on research and innovation, to identify security and development risks in order to prevent them. Of course, sound productive research and innovations are among the tasks of universities and colleges. Thus, they have to be administered in a manner that they could be able to meet this target. Thought, there are multiple challenges standing that tertiary education faces in Liberia, but those can be simply be mitigated had proper and adequate policies being in place with proper implementation and evaluation schemes.

Besides, education sector is not just about subsidizing always, rather it is about series of activities and initiatives such as good governance and leadership, and considering other factors that might directly or indirectly affect education such as security, and health.

References:

- Sabatier, P. A., & Mazmanian, D. A. (1983) Policy implementation. In S. S. Nagel (Ed.), *Encyclopedia of Policy Studies* (pp. 143-169). New York: Marcel Dekker. January 2006
- Sajid Ali Aga Khan University, *Institute for Educational Development, Karachi* ISEA ñ Volume 34, Number 1, 2006
- AN ACT TO ADOPT THE EDUCATION LAW OF A.D. 2001 APPROVED : JANUARY 8, 2002 Published by authority Ministry of Foreign Affairs Monrovia, Liberia April 15, 2002
- INTERNATIONAL HIGHER EDUCATION – NUMBER 63 SPRING 2011
- Higher Education in Africa: Facing the Challenges in the 21st Century
- Liberia students all fail university admission exam 26 August 2013 , <http://www.bbc.com/news/world-africa-23843578>
- Shreyasi Singh, challenges and solutions in India higher education , october 02,2013 (the Diplomat) <http://thediplomat.com/2013/10/challenges-and-solutions-in-indian-higher-education/>
- PARADOXES OF HIGHER EDUCATION REFORMS: IMPLICATIONS ON THE MALAYSIAN MIDDLE CLASS#
- Shreyasi Singh, challenges and solutions in India higher education , october 02,2013 (the Diplomat) <http://thediplomat.com/2013/10/challenges-and-solutions-in-indian-higher-education/>
- Sabatier, P. A., & Mazmanian, D. A. (1983) Policy implementation. In S. S. Nagel (Ed.), *Encyclopedia of Policy Studies* (pp. 143-169). New York: Marcel Dekker. January 2006

Why does policy fail? understanding the problems of policy implementation
in Pakistan - a neurocognitive perspective
Sajid Ali *Aga Khan University, Institute for Educational Development,*
Karachi ISEA ñ Volume 34, Number 1, 2006

REFLEXIONS ON A MASSIVE OPEN ONLINE COURSE 'ACADEMIC WRITING'

*Rosa May-Melendez, MA.,
Rafael Ferrer-Méndez,,MA.,
Gina Pacheco-Balám, MA.,
Alma Sánchez Ph.D.*

Universidad autónoma del carmen, Mexico

Abstract

As part of the different strategies implemented to improve students' abilities in English, professors from the Universidad Autónoma del Carmen (UNACAR) in Mexico added a Massive Open Online Course (MOOC) in one of the English courses. This MOOC called 'Principles of Written English 1' was focused on essay development, grammatical correctness, and self-editing. The purpose was also to investigate a different learning setting and students' performance on online courses. In order to gather data, researches designed a weekly reflection sheet where students were asked to provide their reflexions about the course and the difficulties or novelties found during this workshop. After the analysis of the information, researchers noticed that students are not interested towards online courses because they do not usually take formal online lessons. However, the study revealed they get new information in every session. In conclusion, the use of MOOCs to support on-site classes is useful, but the use of technology, as a mean to learn, must be encouraged before applying online courses.

Keywords: MOOCs, academic writing, English

Introduction

The use of Massive Open Online Courses (Henceforth MOOC's) have become more popular to support the teaching of certain areas or to update knowledge. As MOOC's is an innovative strategy for teaching courses, many people around the world who have access to computers and internet take advantage and make use of it. According to Borys et al. (2014) the main purpose of using MOOC's "is to provide free access to course materials and resources as well as to provide interactive user forums". As mentioned before it is a way to gain knowledge, without investing money.

Some universities offer through these resources different topics based on medicine, biology, math, science, engineering, education, innovation, reading, writing practice in English and so on. Some other universities such as Berkeley the University of California, Tenaris University, Harvard, Tsinghua University and other international schools offer these courses free; the procedure to follow is to register and create an account. If you enroll in any course you are asked to spend 3 or more hours a day in the course and most of the time the length is very short it varies from 3 to 6 weeks approximately.

The definition of MOOC's according to Borys et al. (2004) who points out that Massive means that it is directed to an unlimited number of students. Anyone can enroll without any problem, therefore, it differs from a typical face to face class or online course because there is not a specific number of people that can be registered. Bonk et al. (2015) however, differs from some authors since MOOC's have a start and end dates, charges for a participation if you want to receive a printable certificate and some other aspects that make MOOC's one more online class.

It is open because of several reasons; the first one because it is open to the public, anyone who has graduated from a college or university or simply anyone who is interested in the course can get enrolled. However, it is important to take into account that most of these courses are offered in the English language, that is the reason why an intermediate level proficiency is required in order to understand the instructions, the readings and the whole information given in that language. Second, it is free of charge, and finally, future users can reuse it many times.

It is defined as online course because it is taught via internet, there is no physical attendance required. Although there is not a schedule, the tasks are to be completed within the time set by the instructor of the course, and as a basic requirement, a good internet service is needed. The course is focused on a pedagogical content based on any topic chosen by the instructor and the people who design the course.

For learning a second language, e-learning, as an innovative strategy, has been a very helpful tool for many independent students. Knight (2004, p.12) remarks that "E-Learning is no longer simply associated with distance or remote learning, but forms part of a conscious choice of the best and most appropriate ways of promoting effective learning". What teachers must focus on is learning more than the use of technology.

In the field of teaching a second or foreign language, there are nowadays also MOOC's that can be useful as a support for students of a second language. However, not everyone is open to technology or interested in an online course. Dudeney and Hockly (2007) recommended that if we are teaching adults, we must first discuss if they might be interested in

adding one online component to our course, since some students might not be interested because they spend too much time in a computer or they simply prefer the social relationship that a face-to-face class provides.

Research approach

This study was dealt from a qualitative approach since our main concern was focused on students' reflections and attitudes towards taking any MOOC's. At the same time, the interest of the researchers was to enhance students learning opportunities, as well as strengthening teaching-learning strategies. After all, this approach aims are to "... explore and understand the interactions, processes, lived experiences, and belief systems that are part of individuals, ..." (O'Leary 2010, p. 114) in order to explain or change a situation to improve human conditions.

As part of this approach, the agreed design for this research was an action-research since the main aim of the whole activities involved in the project was to improve students writing and identify their attitude toward learning online, especially on academic writing constraints. According to Hernández Roberto, Fernández-Collado y Baptista Lucio (p. 706), action research is used to improve individual performance, as well as changing a situation with the intention to make it better. That is why, aware of the students needs, and our objectives to train them in writing, this learning strategy and research were implemented for the students described in the corresponding section of this paper.

In order to gather information for analyzing if the objectives of the research were fulfilled, a reflection guide and observations were conducted during the whole learning strategy. Therefore, each participant ended up with a total of five reflection sheets at the end of the course. The reflection sheet consisted on reporting what they had learnt and what had been a challenge to learn along the week.

Subjects

The study was carried out on 13 Mexican students of the faculty of Educational Sciences in the English language degree. They all speak Spanish as their mother tongue and have studied English at the Universidad Autónoma del Carmen for more than 3 years as part of the degree. The age range is from 20 to 24 years old.

Besides, the participants were working on their thesis projects as a product of their course or Research Methodology. The reason for them to participate in the MOOC's course about academic writing was that this course is no longer taught at the English Langue Degree.

Research process

The way the participants were chosen consisted on an open and free invitation to participate in the MOOC's "Principle of written English 1" offered by the University of Berkely the University of California, and it was free online course, which is regularly taught. This invitation was addressed to all 34 students taking Research Methodology, who were working on their thesis projects. The purpose to invite the students was to identify how willing to take an online course the pupils were, nonetheless only 13 decided to begin the course due to a lack of time since the term was about to finish, and most students were more concerned on their compulsory courses grades.

The course lasted 5 weeks. The first week had activities to review grammar and practice writing. The course had some additional homework about the topic taught per week, for instance the first week was based on some grammar topics and the extra assignment consisted on practicing with other topics that they could choose among the list. The second week had activities focused on writing sentences and paragraphs. The third week had activities concerned for writing thesis statements. And the fourth and fifth week, the student had to work on the assignments to turn an essay as a final assignment.

After every week each participant registered his own information on a reflection sheet by responding three main hints focused on their perception about what they learned and what was difficult or represented a challenge to them. At the same time, students' records on their attitude toward the online course were registered.

Results

On the first week, thirteen participants were registered on the MOOC's showing a genuine interest on taking the course. At the same time, they expressed their interest to study English grammar and specific aspects about academic writing. These aspects were of utmost interest to the students because they wanted to use such information on writing their thesis, something they were dealing with.

However, even when these 13 students immediately responded to the invitation, the expected participation on the course was not reached, since a total of 34 students were invited. This means, that the non-interested students in taking the course was higher than the one interested on participating.

On this first week, the thirteen students appointed for the course had to become familiar with the platform. The working platform where the students had to work was really friendly and it had a clear guide about the activities the students had to do (See Fig. 1.1). As a monitoring action, a professor joined the course in order to identify the students participating in

this learning experience and registered all their participations during the course.

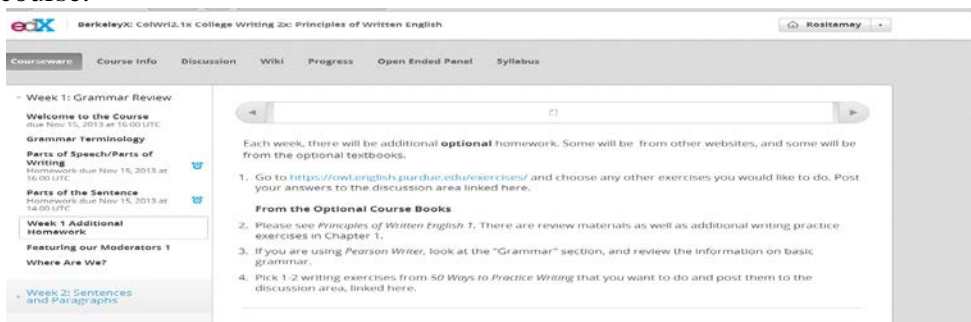

Fig. 1.1 web site

During the course, only three students participated in 5 weeks the course lasted. Five students participated only 4 weeks. Three students participated 3 weeks. Two students participated only 2 weeks. At the same time, the participants had to write down their reflection sheets.

SUBJECT	Reflection 1	Reflection 2	Reflection 3	Reflection 4	Reflection 5
S1	X	X	X	X	X
S2	X	X	X	X	
S3	X	X	X	X	
S4	X				
S5	X	X	X	X	
S6	X		X	X	X
S7	X	X	X	X	
S8	X	X	X		
S9	X	X	X		
S10	X	X	X	X	X
S11	X	X	X		
S12				X	
S13	X	X	X	X	X

Table 1.2 Participation per week.

Although 3 people completed the whole sessions, many of them completed more than 3. However, the total of students who finished the course, if we consider the total number of the invited students and the actual number who registered, was very low.

Among the most outstanding records the participants did on their reflection sheets during the course are the following:

Week 1

What I did not know...

- *How to structure a sentence and how to organize the parts of it.*

Now, I have clarified...

- *Grammar terminology, parts of speech and writing, parts of a sentence, how a sentence is structured, and organize parts of a sentence.*

I feel unsure about...

- *Nothing.*

Week 5

What I did not know...

No comments

Now, I have clarified...

- *how to write an essay appropriately.*
- *Edit and review the essay*

I feel unsure about...

- *How to write the essay in a correct way.*

Discussion

It seems that the idea of taking an online course made students feel afraid and excited at the same time. As seen from the results, it is remarkable that the number of students that registered in the course is less than the media of all students invited to participate. Most of them stated that one of the reasons they did not join the course was the end of the term that was about to finish by the time the course began, and the fact that they had some tasks that they had to deliver. An extra course would increase stress on their class activities something that was not previously discussed at the beginning of the course, and that was necessary to be done (Dudeney and Hockly 2007).

Anyway, the students that joined the course, at the very beginning showed enthusiasm and interest, but as the days passed and the activities began, they lost or at least diminished their participation. The students showed a lack of responsibility to fulfill the activities from the course.

The reflection guide demonstrated to be too general, and the information the students registered on them were poor about their real reflection about the activities. Most of them only reported facts about the things they were learning or what they lacked to learn, but there is not an analysis or reflection about the reason why they learned, or why they could not learn, or what is still difficult for them. At the same time, they do not express a single comment if the information studied in the course was really helping them to improve their learning, and especially to write their thesis, which was one of the aims why they were invited to participate in the course.

Due to the type of course, the observation to the students were minimum since from the few that participated, most of them did the activities at home or in a place where the professors rarely could see them. Any way,

a few records about their attitude demonstrated low responsibility and a lack of interest to learn, especially about academic writing.

Even when most of the participants mentioned to be interested and excited to learn more, most of them did not end the course, which demonstrate the reverse. Something positive on the students' part is that most of the participants (13 students) recorded their advances and showed they were effectively learning (Knight 2004).

Conclusion

Although students did not finish the training and the participation was low, they had track of their learning process. We can attest learning took place, since every student after doing the exercises were self evaluated to find out if they had learnt something about the topic. Taking into account that the semester was about to finish, and it could have been an important factor why students did not complete the course, at least a few did participate in the course and were eager to face a new learning experience.

A factor which could have affected on the students registration and participation was that students are not used to taking courses online. There is not any course offered in the language degree under this modality, and students do not have the habit or formality to self-learning that is why it is important for our degree faculty to be aware of this, and make use of this type of teaching learning online tools.

Regarding the aims of this research, they were partially fulfilled since the students reflections were not really gathered at all, and the students attitude toward taking a MOOC were recorded, but a deeper study is necessary. On the other hand, the learning aims of the strategy were fullfilled, at least on the students participating. The participants had the opportunity to learn about academic writing, and work on a new learning tool.

References:

- Bonk, C., Lee, M., Reeves, T., Reynolds, T., (2015) MOOC's and Open Education around the world. New York. Roulledge.
- Borys, M., Caffiau, S., Dugdale, J., Laskowski, M., Luján, S., Meillon, B., Milosz, M., Plechawska-Wojcik, M., (2014). *6th international conference on education and new learning Technologies*. Barcelona, Spain: IATED.
- Dudeny, G., Hockly, N., (2007) *How to teach English with technology*. Essex, England: Longman.
- Knight, S. (2004) Effective practice with e-learning. The Joint information systems committee. Retrieved from www.jisc.ac.uk/elearning_pedagogy.html.

O'Leary, Z. (2010). *The essential guide to doing your research project*. London: Sage.

Hernández, R., Fernández, C., y Baptista, L.,(2010). *Quinta Edición. Metodología de la investigación*. México: McGraw Hill

Great on-line courses from the world's best universities. (n.d.). Retrieved from <https://www.edx.org/?gclid=CKbShbm9uMcCFQwyaQod-HkGZA>

GENDER IMBALANCE IN THE ACADEMIA IN NIGERIA

Prof. James Adeola Olaogun

Department of Sociology, Ekiti State University, Ado-Ekiti, Nigeria

Anthony Abayomi Adebayo

Department of Sociology, Federal University Oye-Ekiti, Nigeria

Sr. Dr. Catherine Ajoke Oluyemo

Department of Sociology, Ekiti State University, Ado-Ekiti, Nigeria

Abstract

The fact that there is gender imbalance at work and in social institutions continues to generate debates, discussions and concerns. Women have somewhat experienced gender opportunity restrictions and ceiling across societies down the ages. What is problematic is the consistency and persistence of the imbalance in Nigeria even when change is constant and reverberating around the globe. A survey of selected tertiary institutions in Nigeria revealed that there is gender imbalance in the constitution of the faculty staff. The men clearly outnumber the women. The paper proffers that for rapid societal development and greater sense of belonging, the discrimination against women should stop, especially in the academia who uphold the citadel of learning and that gender sensitivity in appointments should be put at the front burner.

Keywords: Gender Imbalance, academia, gender sensitivity, restrictions

Introduction

Gender discrimination refers to the practice of granting or denying rights or privileges to a person based on their gender. This kind of discrimination leads to unfair treatment directed to individual or a group on the basis of their gender which denies them their rights, opportunities or resources (Chauraya & Mugodzwa, 2012). In some societies gender discrimination is a long standing practice and it is acceptable to both genders. Gender discrimination is closely related to gender stereotypes and sexism which often is a barrier to developing harmonious working environment. This kind of discrimination manifests in the form of sexist language, sexual harassment or discrimination on the job (Maruzani, 2013).

Gender issue has been a focal point of discussion in many regional, national and international fora. Issues bordering on inequality and inequity are often addressed as well as all forms of discrimination against women. The 1999 Nigeria constitution makes provision for equality of women, guarantee the rights and protects the interest of women considering the religious, traditional and cultural norms that govern the society. The role of women in nation building can never be underestimated. In fact, this is why the issue of role of women in nation building and international development has continued to attract global attention especially relative to the nexus of gender equality and sustainable development (Akanle and Olutayo, 2012, Akanle, 2011, Adebayo and Akanle, 2014).

Gender discrimination is in every society but problematization is common in Africa with its patriarchal system having absolute dangerous implications manifesting in institutions of higher learning. While a number of efforts have been underway to rectify gender imbalance, much still remains to be done across all educational sectors. There seem to be a natural gender role distinction all over the world, which has created gap opportunities between men and women (Nwajiuba, 2011). Over the past decades, the widespread 'unequal' power relations between men and women has continued to generate discussions and has turned out to be a crucial scholarly debate in developmental and academic discourses. One of the major foci of the 1975 UN Nigeria Assembly Conference was a critical examination of the problems and challenges that impede active participation of women in education, socio-political and economic development. Intellectuals and policy makers brainstormed on the problems militating against active participation of women in the global development agenda. Recently, the Millennium declaration overtly recognises the equal rights and opportunities for men and women (Adebayo and Akanle, 2014).

This trend has recently become of great concern to many who are agitating that women should be given the opportunity to contribute meaningfully to development and be part of policy-making bodies. Thus, women have become the focus of international programmes and conferences aimed at integrating them into the development process on an equal basis with men. Within the past three decades, the United Nations organized World Conferences on Women in Mexico City (in 1975), Copenhagen (in 1980), Nairobi (in 1985) and Beijing, China (in 1995). The deliberations at these conferences include how to provide gender equity in areas of development, among other issues as evidences abound that several negative gender relations such as gender-based divisions of labour, disparities between males and females access to power and resources, gender biases in rights and entitlements, remain pervasive in Nigeria (National Gender Policy, 2006).

Furthermore, some of the conventions that Nigeria signed and ratified include ,The United Nations International Declaration of Human Rights (1948), The Convention on Economic , Social and Cultural Rights (1966) , The Convention On the Elimination of All Forms Of Discrimination Against Women (CEDAW, 1979), Beijing Declaration and Platform for United Nations. (1995), SADC Declaration on Gender and Development and its Addendum on the Prevention and Eradication of Violence Against United Nations (1997), the Millennium Development Goals (2000) and the African Union Protocol on the Rights of Women in Africa (2004) (Gberevbie et. al. 2014). All these were designed to help eradicate gender inequality in the society.

Gender Discrimination in Employment

In the past, there were concerted and determined efforts to deprive the women of employment opportunities (Adebayo & Akanle, 2014). From 1841 until the outbreak of the First World War in 1914, a combination of pressure from male workers and philanthropic reformers restricted female employment in industry. Women were seen by the male factory workers as threat to their employment. As early as 1841, committee of male factory workers called for the gradual withdrawal of all female labour in the factory. According to Hacker (1972), with the employment of women as wage earners, men were quick to perceive them as a rival group and make use of economic, legal and ideological weapons to eliminate or reduce their competition. They excluded women from the trade unions, made contracts with employers to prevent them from hiring women, passed laws restricting the employment of married women, caricatured the working woman, and carried on ceaseless propaganda to return women to the home and keep them there. This justifies the Victorian ideology that a woman's place is in the home. Thus, a combination of factors, which included ideology, the banning of child labour, and restrictions on the employment of women, locked the majority of married women into the mother-housewife role.

However, Oakley (1981), states that from 1914 to 1950, there was a tendency towards the growing employment of women coupled with the retention of housewifery as the primary role expected of all women. During these years, women received many legal and political rights, for example, the vote in 1928, but these had little effect on the central fact of their lives: the mother-housewife role. In the twentieth century British society, the role of housewife-mother became institutionalized as 'the primary role for all women'.

Women have to countenance wide-ranging predicaments related with gender biased discriminatory factors in organizations (Neathey, 2003; Sattar, Imtiaz, & Qasim, 2013). Women are frequently attributed to have less

aptitude as compared to men for various management and administrative positions. As a result of this women habitually acquire less job promotions and carrier advancement opportunities as compared to men due to various stereotypes narrated with job promotion of the female employees (Morrison, et al. 1990; Reskin and Ross, 1990). In the labour market, all the occupations must be obliged on the basis of skills of the organizational employees. Unfortunately, there was a superlative segregation among occupational opportunities on the basis of gender role where female employees acquire less occupational advantages as compared to their male colleagues (Mathipa and Tsoka, 2001). Women are frequently considered to be appropriate for household tasks such as child caring, nurturing and household management (Miller, et al. 1992).

It is not possible to ignore women employment even though the employment pattern in Africa still favours men more than women (Mensah, Biney and Ashang, 2009). Sutherland (2008) submitted that women face serious challenges in gaining access to their daily resources and bargaining power. These adversely affect the women, hence they are considered in the world as the most vulnerable to socio-economic depression. All these have culminated into huge gender gaps in literacy, education, health and access to power, despite all these women are still important and they constitute a visible force in terms of development and socio-economic changes of any society (Adegun, 2012).

Gender Discrimination in the Academia in Nigeria

Organizations are established basically to achieve the goals of profit maximization or provision of quality services to enhance the living standard of the people in any society. To achieve these goals, competent employees are required. In addition, availability of quality management in terms of skills, education and experience that abhors gender discrimination of any kind determines organizational effectiveness (Gberevbie, 2014).

Academic profession, like any other profession at the beginning of time was a single sex profession (Singh, 2002) cited by Egunjobi, (2009). But the World War II had actually opened the gateway to women emancipation in Europe and the USA before any University was introduced to Africa. Under the colonial imperialism, whatever operated in UK became law in Nigeria. Today in the Commonwealth nations, the situation of women in academics has improved. The percentage of women employed as full time academic staff ranges from the highest of 50% in Jamaica to the least of 9.5% in Ghana, with a Commonwealth average of 24%. The smallest percentages were found in Ghana 9.5%, Nigeria 13.6%, Tanzania 11.0%, Zambia 10.9% and Zimbabwe 9.8% all in Africa, for example, University of Ilorin, also showed female/male ratio of 11.6% to 88.4% (Egunjobi, 2009).

Like in many professions, discrimination against women in academics in the past existed throughout the world.

According to Egunjobi (2009), women academics in Nigeria were denied maternity leave under the University Law and in some cases they were not allowed to get married or have children. Some women were even refused employment despite the fact that they were qualified because it was felt that the women would be a distractive influence in the laboratory working in an all male career (Adegun, 2012).

Like any other sector, the ability of the Nigerian universities to achieve their goals and objectives is a function of its ability to attract competent workforce irrespective of whether they are males or females (Gberevbie, 2006). Workers in an organization, irrespective of their gender, are classified into management/senior employees and others. The management/senior employees are responsible for the overall administration of the organization for enhanced performance. These categories of employees provide the direction through effective leadership to achieve the overall goals of the organization; and this is where discrimination against women is mostly pronounced in Nigerian universities (Gberevbie, et. al. 2014). Nigeria, like other countries in Africa, has almost equal number of males and females that make up the total population. For instance, the last Nigeria's national population census that took place in 2006 showed that females were 68.3 million, which is about 48.78 percent and males constituted 71.7 million, which is 51.22 percent of the total population of about 140 million. In such a situation, it is out of place, therefore, to discriminate against women in the area of leadership in organizations, particularly in the Nigerian universities, if enhanced performance is to be achieved (Olomola, 2008; NPC, 2009; Gberevbie, et. al. 2014).

Table 1: Academic Staff Profile in Selected Universities Showing Disparity in Gender (2007/2008)

INSTITUTION	MALE	FEMALE	TOTAL
UNN	1,017 (73%)	367 (27%)	1,387
FUTO	452 (83%)	93 (17%)	545
ESUT	210 (66%)	110 (34%)	320
IMSU	314 (87%)	47 (13%)	361
IBADAN	1,091 (82%)	243 (18%)	1,334
CALABAR	460 (82%)	102 (18%)	562
PORT HARCOURT	416 (88%)	57 (12%)	473

Source: Nwajiuba, 2011; Adebayo & Akanle, 2014.

Table 1 reveals that in the selected Universities under consideration, the proportion of female lecturers to male lecturers is abysmally low. The female gender continues to occupy the back bench in the academia.

Table 2: Gender Composition of academic staff in Ekiti State University, Ado-Ekiti, Nigeria

FACULTIES	MALE	FEMALE	TOTAL
Arts	47 (87.0%)	7 (13.0%)	54
Agriculture	34 (73.9%)	12 (26.1%)	46
Education	47 (65.3%)	25 (34.7%)	72
Engineering	42 (93.3%)	3 (6.7%)	45
Law	16 (76.2%)	5 (23.8%)	21
Management Science	21 (71.3%)	2 (8.7%)	23
College of Medicine	34 (91.9%)	3 (8.1%)	37
Social Science	51 (92.7%)	4 (7.3%)	55
Science	78 (78.8%)	21 (21.3)	99
TOTAL	366 (81.7%)	82 (18.3%)	448

Source: Statistics and Planning office EKSU Nov. 2011; Adegun, 2012.

Table 2 above shows that eighty two (82) out of a total population of 448 in the University are female while 366 are males.. This shows that 18.3% are females while 81.7% are males. It should be noted that only 3(8.1%) females are in the College of Medicine out of 37 Lecturers, even though the College has just taken off about two years ago unlike other faculties that have been in existence since establishment of the University in 1982. The faculty of Engineering has 6.7%, female Lecturers as against 93.3% males. In the Faculty of Management Science 8.7% are females and 81.3% males and Social Science has 7.3% Females and 92.7 Males. This has the least percentage in terms of female employment. Faculty of Education has 34.7% female and 65.3% male and Faculty of Agriculture has 26.1% females and 73.9% males. Others like faculties of Arts has 13.0% females, Faculty Law with 23.8% female and Faculty of Science with 21.3% females.

Table 3: Gender Pattern of Academic Staff by Designation at the Federal Polytechnic, Ado-Ekiti

DESIGNATION	MALE	FEMALE	TOTAL
Chief Lecturer	47 (90.3%)	05 (9.7%)	52
Principal Lecturer	38 (86.3%)	06 (13.7%)	44
Senior Lecturer	48 (92.3%)	04 (7.7%)	52
Lecturer I	53 (85.4%)	09 (14.6%)	62
Lecturer II	51 (83.6%)	10 (16.4%)	61
Lecturer III	43 (86.0%)	07 (14.0%)	50
TOTAL	280 (87.2%)	41 (12.8%)	321

Source: Adegun, 2012; Adebayo & Akanle, 2014

Table 2 shows that in total across all cadres, 87.2% of the Lecturers are male, while 12.8% are female in the Polytechnic.

Table 3: Gender Pattern of Academic Staff by Designation in the College of Education, Ikere-Ekiti

DESIGNATION	MALE	FEMALE	TOTAL
Chief Lecturer	31 (73.1%)	07 (26.9%)	38
Principal Lecturer	17 (80.9%)	04 (19.1%)	21
Senior Lecturer	36 (75.0%)	12 (25.0%)	48
Lecturer I	15 (53.6%)	14 (46.4%)	29
Lecturer II	34 (73.9%)	12 (26.1%)	46
Assistant Lecturer	45 (71.4%)	18 (28.6%)	63
Graduate Assistant	3 (100%)	00	03
TOTAL	181 (64.9%)	67 (35.1%)	248

Source: Adegun, 2012; Adebayo & Akanle, 2014

Table 3 reveals that also across all cadres, 64.9% of the Lecturers are male while 35.1% are female.

Discussion

The above statistics attest to the gross imbalance in the number of women employed as academics compared to the men in the tertiary institutions in Nigeria. Gender inequality saturates all aspects of Nigerian life. They manifest in the family institutions, educational sector, labour market, politics and social service institutions. Indeed, discrimination against women in Nigeria is manifested within and outside the home.

Gender discrimination is a phenomenon that has negative implications on development of organizations and people. In this study, gender discrimination could be seen as obstacles against the employment or appointment into leadership positions or authority of an individual based on sex. It is a deprivation of rights of the individual that could have contributed positively to the development of the organization and the society at large. These rights include political, marriage/family and employment (Olomola, 2008). The fact remains that prosperity of nations is a function of the effective utilization of their factors of production such as land, capital, technology and labour. Although some studies show that Nigerian women have appreciably participated in the formal sector, their impact is still low relative to their male counterparts (Adebowale, 2009).

In recognition of the ills of gender discrimination against women, the 1999 Constitution of the Federal Republic of Nigeria provides for non-discrimination and of equality between the sexes as basis for societal development (Gbadamosi, 2014). To further overcome the challenge of gender discrimination against women in the formal sector of employment, the Federal Government of Nigeria put in place strategies in its policy on women employment to include: sponsored training in the public and private sector institutions on gender sensitization programmes on the role of women in the development process in order to raise awareness of women in the

society; sensitization of the public through mass mobilization campaigns about the need for women to be in formal sector employment in order to break traditional attitudes and stereotypes about women's work; encouragement of women's active participation in labour relations; and the review of labour laws to include more and better protective measures for women workers (Adebowale, 2009).

However, the study shows that despite the effort of the Federal Government to put a stop to the menace of gender discrimination against women both in the public and private sectors of the economy, the ugly practice still persists. Sex discrimination and subordination against women by their male counterparts highly limits women's access to the acquisition of the forces of production as well as opportunities to high status and job positions, educational qualifications notwithstanding. Instead, they are largely employed in lower status jobs even in the Nigerian universities than their male counterparts in spite of their large population size and enhanced educational qualifications. Commenting on the origin and reality of gender discrimination against women in management, politics and social affairs, it was argued that although the 1999 Constitution of the Federal Republic of Nigeria provides for non-discrimination and equality between the sexes, in reality the gap between the law and the practice is quite wide and seemingly parallel (Olomola, 2008).

Thus, women not only have heavier work burden and lower earnings than men, but were also constrained on upward mobility because of cultural, legal and labour market barriers. This situation has also translated into fewer women been in high status occupation and top management position, not only in tertiary institutions, but in all endeavours of work life (Nwagwu, 2009).

The under-representation of women reflects not only continued inequalities between men and women but missed opportunities for women to contribute to solving the most pressing problems facing human kind. In this sense, gender differentials constitute an important and an enduring aspect of labour market around the world (ILO, 2003). Although, this situation is improving, but women's present job status has not yet guaranteed the desired representation in the work-organisation where participation is characterised by their representation in the lower echelon or occupational managerial career. For instance in Nigeria, women make up about half of the country's population, they remain under-represented in the formal labour force (Aina, 2012).

Factors Responsible for Discrimination in the Academia

Several factors have been adduced as militating against the active participation of women in the formal labour sector in Nigeria. Prominent

among these militating factors against women are the *Cultural and Societal Factors*. Discrimination against women in Nigeria is rooted in traditional beliefs and practices that regard the man as superior to his female counterpart (Gberevbie, et. al. 2014). Socialization of children into specific roles by parents and relations in conformity with prescribed gender stereotypes is a contributory factor in the marginalization of the female gender in the formal labour sector (Adebowale, 2009).

Customary Practices across Nigeria generally hold that the man is the head of the house and has the absolute control in the decision making process of the home. That is, a patriarchal society reinforces a norm that views men as leaders and women as followers (Belknap & Porter, 2006) Nigeria is a highly patriarchal society, where men dominate all spheres of women's lives. Women are in the subordinate position and male children are preferred over the female (World Bank 2005). The practice of bride price has led to the idea of ownership of the woman, the exchange of bride price being evidence of a commercial transaction. The bride price is understood by many to symbolize the sale of the girl and ownership by her husband and family (Eze-Anaba, 2006). This has contributed in no small measure to the repression of the aspirations of women, as permission would have to be taken from her 'owner' before she embarks on pursuing any endeavour in life, academics inclusive. It is on record that many husbands have stopped their wives (properties) from working or seeking employment.

Political Factors are also strongly implicated. In Nigeria, there is no political will to implement International instruments that protect women rights. Since females are not adequately represented in Nigerian politics, gender-sensitive laws and policies are not a priority either at the state or national level (Oladeji, 2009). As a result, there has been no attempt in the direction of looking into the minimum percentage of lecturers reserved for women in the tertiary institutions in Nigeria.

The various religions in Nigeria subscribe to the idea that the man is head of the family and has greater control and decision making powers. Almost all religions in Nigeria actually preach in favour of women absolute domestic role. That is women should be absolutely at home to care for their children and husband without external engagements. The religious teachings most hold that the woman is the weaker vessel and plays the second fiddle in marriage partnership. As such, the woman is taught to be subservient to the man.

The pattern of education has also contributed in no small measure to the subjugation of women. According to Lauer and Lauer (2002), the traditional roles assigned to women inhibit their commitment to higher education, which in turn diminishes their prospects in formal labour participation. Females are withdrawn from school into marriages. While the

male counterparts continue to pursue further education, the females are put under pressure to marry early because they are thought to require minimal education to become good wives.

The direction of life choices for the woman is directed by the man. This line of thinking has subjected women to varying degrees of difficulty in making career choices in life. Illiteracy among Parents is another major factor. Some parents in the rural areas and even in the urban to some extent, still have not realized the importance of education for girls. They still believe that it is a waste of resources since the girl will be married into another family (Nwajiuba, 2011). Consequently, if parents refuse to give girls equal educational opportunities like the boys, it will surely come to bear on the gender imbalance in employment.

Recommendation and Conclusion

This paper has established the existence of gross gender imbalance in the employment of lecturers in the tertiary institutions in Nigeria. This is likely to continue to generate debates until it is adequately addressed. As seen in the data above, the wide margin in the proportion of men to women in the academia is an issue for serious concern. In the pursuance of nation building and development, which the tertiary institutions typify, women should be accorded a much better role than they are allowed to play at the moment. More women should be engaged into the academics. In order to realise this, the following recommendations should be considered:

Policies that will ensure equal gender representation should be formulated, adopted and enforced by government.

Parents should de-emphasize gender socialization that prevents female from acquiring scientific and technological skills.

Gender discriminations based on employers' perception of appropriate work roles for the sexes should be addressed by government.

The pressure of marriage that prevents females from going for further studies to qualify for academics should be addressed and discouraged by parents.

Parents should be encouraged to give equal opportunities to their children in educational pursuit irrespective of gender.

Socio-cultural stereotype that views women as 'properties' of the men should be jettisoned and a level playing field should be allowed for all irrespective of the gender.

Interventions in the form of making laws that would prescribe the minimum percentage of women in academic should be vigorously pursued.

Conclusively, this paper has traced the history of gender inequality in the academia. It has established the gross gender imbalance in the employment of lecturers in the tertiary institutions in Nigeria. As seen in the

data above, the wide margin in the proportion of men to women in the academia is an issue for serious concern. More women should be engaged into the academics. The paper believes that the gender imbalance in the academia in Nigeria is not palatable for national integration and development. The adoption and implementation of recommended policy measures will go a long way in improving gender relation in the academia in the Nigerian society thereby enhancing the task of national development in the 21st century and the achievement of the Millennium Development Goals and sustainable development.

References:

- Adebayo, A. and Akanle, O. (2014). Gender and The Academy in Nigeria. *African Journal for the Psychological Study of Social Issues*. 17 (1); pp. 147-154.
- Adebowale, A. (2009). Gender Differentials in Formal Labour Participation in Nigeria. In Nwagwu, et. al. (eds). *Women Issues in Nigeria*. Ibadan: Royal People Ltd.
- Adegun, A. O. (2012). Gender Factor and Labour Participation among Academic Staff in Tertiary Institutions in Ekiti State, Nigeria. *European Journal of Educational Studies* 4(2): 249-258.
- Akanle, O. 2011. The Sociology of Gender Equality and Development and Development in Democratizing Nigeria. *The Nigerian Journal of Sociology and Anthropology*. 9. Pp. 22-36.
- Akanle, O. And Olutayo, A.O. (2012). Gender and Poverty Eradication in Nigeria: Women's Right the Missing Link. *East African Journal of Human Rights*. 18 (1), pp. 227-241.
- Aina, O. Two Halves Make A Whole: Gender at the Crossroad of Nigerian Development Agenda. (Inaugural Lecture Series 250), Obafemi Awolowo University, Ile-Ife, Nigeria.
- Belknap, J. And Porter, H. (2006). 'Intimate Partner Abuse' in Renzetti, C.; Goodstein, L. And Miller, S. L. (eds). *Rethinking Gender, Crime and Justice*. California: Roxbury Publishing Company.
- Eze-Anaba, I. (2006). *Domestic Violence and Legal Reforms in Nigeria: Prospects and Challenges*. London: Berkeley Electronic Press.
- Egunjobi, O. A. (2008) Women in Academics: The untold story of Gender Inequality and Discrimination against Women in the Ivory Tower. Lead Paper presented at the seminar organized by the National Association of women in Academics (NAWACS), University of Ado-Ekiti Chapter, Ado-Ekiti.
- Gbadamosi, G.S. (2014). Gender Differentials in the Management of Tertiary Institutions in Ekiti State, Nigeria. An Unpublished Masters Thesis

Submitted to the department of Sociology and Anthropology, Ekiti State University.

Gberevbie, D.E.I. (2006) "Recruitment and Quality Academic Staff Selection: The Case Study of Covenant University. *Ife Psychologia*. 14 (2). pp. 117-141.

Gberevbie, D.E., Osibanjo, A.O., Adeniji, A.A. and Oludayo, O.A. (2014). An Empirical Study of Gender Discrimination and Employee Performance among Academic Staff of

Government Universities in Lagos State, Nigeria. *International Journal of Social, Human Science and Engineering*, 8 (1), pp. 101-109.

Hacker, H. (1972). 'Women As a Minority Group' in N. Glazer-Malbin and H.Y. Waehrer (eds) *Woman in a Man-Made World*. London: Hienemann.

International Labour Organisation, (2003). "Gender, Poverty, and Employment: Issues, Trends and Approaches, Capacity-Building Program on Gender, Poverty and Employment", Geneva.

Lauer, R.H. and Lauer, J.C. (2002). *Social Problems and the Quality of Life*. New York: McGraw Hill.

Maruzani, N. (2013). Gender Discrimination in Retail Shops' Personnel: The Case of General Dealer Shops at Murambinda Growth Point, Buhera, Zimbabwe. *International Journal of Asian Social Science*, 3(3): pp. 669-681.

Mathipa, E. R. and E. M. Tsoka. 2001. "Possible Barriers to the Advancement of Women to Leadership Positions in the Education Profession." *South Asian Journal of Education*, 12 (4), pp. 324-331.

Mensah, D.O., Biney, I.K., Ashong, G.A. (2009). Gender Issues that Impinge on Access and Equity of the Master's Programme in the Institute of Education, University of Ghana. *International journal of Higher Education Research*. 1(1).

Miller, D. V., Jablin, F.M., Casey, M.K., Horn, M.L. and Ethington, C. (1992). "The Maternity Leave as a Role Negotiation Process" *Journal of Managerial Issues*, 8 (3), pp. 293-299.

Morrison, A. M., V. Glinow and A. Mary. (1990). "Women and Minorities in Management." *American Psychologist*, 45 (2), pp. 200-208.

National Gender Policy: Federal Ministry of Women Affairs and Social Development (2007). Federal Republic of Nigeria. Abuja: Amana Printing Ltd.

Neathey, F. (2003). "Monitoring Progress towards Pay Equality." Equal Opportunities Commission, Manchester.

Nejati, M. (2009). "Sex Discrimination in Job Opportunities for Women" *Journal of Sex Roles*, 8, pp. 45-52.

NPC (National Population Commission) (2009) *Official Gazette of the Federal Republic of Nigeria*. No. 2. Vol. 96. February 2. Abuja –Nigeria.

- Nwajiuba, C.A. (2011). Culture and Sex Imbalance in Higher Education in Nigeria: Implications for development. *Educational Research* 2(3): 926-930
- Nwagwu, H. (2009). Overview of Women Issues in Contemporary Nigeria. Ibadan: Royal People Ltd.
- Oakley, A. (1972). *Sex, Gender and Society*. London: Temple Smith.
- Oladeji. M.O. (2009). Dimensions of Domestic Violence Against Women in Nigeria, in Kehinde, A. (ed.). *Gender and Development. Essential Readings*. Ibadan: Hope Publications Ltd.
- Olomola, O. (2008) "Adoption of convention on Elimination of All Forms of Discrimination Against Women (CEDAW) and Women Rights in Nigeria – A wild goose chase?" *African Journal for the Psychological Studies of Social Issues*. Vol. 11 (1 & 2). April and September. pp. 92-104.
- Reskin, B. and Roos, P. (1990). "*Job Queues, Gender Queues*". Philadelphia: Temple University Press.
- Sattar, T., Imtiaz, M. & Qasim, M. (2013). Gender Biased Discriminatory Factors Affecting the Career Progression of Female Employees in Private Organizations of Multan City Pakistan). *Journal of Economics and Sustainable Development*, 4 (3), pp. 279-294.
- Sutherland, C. (2008). *Gender Equity Remains a Dream*. World Bank. Washington D.C.
- World Bank (2005). *Gender Equality as Smart Economic: A World Bank Group Gender Action Plan (Fiscal Year 2007-2010)*. Washington DC.

SCIENCE AND TECHNOLOGY IN AFRICA FOR THE TWENTY FIRST CENTURY: PERSPECTIVES FOR CHANGE

Olatunbosun Emmanuel Ogunseemi, B.Sc.Ed, M.ED

College of Education, Ikere-Ekiti. NIGERIA

Abstract

There is no doubting that the role of science and technology in modern society is changing. More importantly, all the challenges facing the world and communities in Africa particularly today depends solely on science and technology education to find appropriate solution. It is noteworthy in this century that nations will wholly dependent on others as 'experts' without science and technological knowledge. But with it, they will be empowered to become participants rather than merely observers. Science and technology in this sense is more than a means for getting ahead in the world of work. It is a resource for becoming a critical and engaged citizen in a democracy. However to realize this, the teaching of science and technology in schools should help in development of science and technology literacy. Also in the formation of scientific and technological attitude, this is essential to dispel social evils as well as in the development of open mindedness and decision taking ability. Therefore, this study suggests the teaching and learning of science and technology in schools with the looking glass of 21st century skills for efficient pedagogical format and content responsibility by the teachers and the society. This perspective involves the position of government as policy formulators, the teachers as policy implementers and disseminators as well as the society as policy facilitators.

Keywords: Knowledge, Modern society, 21st century skills, Education, Teacher and democracy

Introduction

There is recognition that creative and innovative learning skills are important for the emerging work environment in the 21st century. On this note, in agreement with (Lazonder, Pascal and Hagemans, 2008), natural skills such as successful problem solving requires a strong relevant knowledge as well as the will to acquire the knowledge as shown in (Griffin, Care and McGaw, 2012). The "Will" which reflects the motivation to

approach difficult problems and persistency towards a solution was also a concern according to European commission (EC, 2007). Taking a clue from (Fernandez, Holbrook, Malmok-Naaman and Coll, 2013), there is an awareness that science and technology educations can play a role in guiding students towards their expected role within the society as responsible citizens, while still building a background for future education and for lifelong learning.

However in line with National Research Council (NRC, 2010), this incorporate a range of generic skills such as adaptability, complex communication, social skills, non-routine problem solving, self-management, self-development and system thinking. Globalization according to (Levy and Murnane, 2005) relating to technological advancement, scientific innovation, paradigm shift in work force demands are redefining the broad skill set that students need to be adequately prepared to participate in, and contribute to today's society. In another study by (Binkley, Erstad, Herman, Raizen, Ripley, Miller-Ricci and Rumble, 2012), it has been indicated that within science education related attributes encompass critical thinking, problem solving, communication and collaboration. Hence, there is the need for science and technology education to meet society expectations all over the world.

Therefore, attention is thus needed to clarify the purpose of science and technology education in the 21st century for greater employability, social responsibility and an interest in lifelong learning in an ever developing, knowledge based world. This work in agreement with (Fensham, 2008) reviews emerging issues in the field of science and technology as related to the 21st century education in the following areas.

1. 21st century education
2. Scientific and technological literacy
3. Educational purposes of science and technology
4. Quality assurance of science and technology Education

1. The 21st Century Education

The 21st century of seems quite different to the previous century due to capabilities the citizens need for work and self-actualization. In response, According to Dede, (2007), society educational systems must transform their objectives, curricular, pedagogies and assessments to help all students attain the sophisticated outcome requisite for a prosperous attractive life style based on effective contribution in work and citizenship.

However, a conceptual frame work for understanding the challenges and opportunities involved in a transformation will definitely give rise to a new pedagogy to attain sophisticated 21st century understanding and performance. Every society is presently at the mercy of the 21st century skills which

learners must master to cope with the drastic global changes in line with (NCREL/Metri, 2003; Partnership for 21st century skills, 2006; Leitch Review of Skills, 2006 and AACU, 2007).

Clearly, educational objectives in the 21st century will need to distinguish between knowledge and skills a learner must have to cope with the world of works. (Scardamania and Bereite, 2006) research in cognitive science has established that knowledge and skills are richly intertwined, rather than knowledge as content on which skills acts as a process. The frameworks therefore categorizes what student needs for the 21st century as understanding and how student actualize those understanding in practice as performances based on interwoven content knowledge and process skills which is a more accurate depiction of has the mind works.

2. Science and Technological Literacy

Many definitions of scientific and technological literacy have been developed, (Holbrook and Rannikmae, 2009) sees it to encompass the creative use of evidence based knowledge and skills while recognizing personal and social attributes. Also, (Feinstein, 2010) in another study seeks wide meanings to encompass societal and work force concerns and concentrate on a few big scientific ideas, rather than stress content information knowledge. In the same vein, (Choi, 2011) suggested the need to include other aspects such as mega-cognitive and self directing student abilities alongside content knowledge, habits of mind, character and values as well as science as a human endeavor.

In another study, (Feinstein, 2011) argues that science education should focus on the “usefulness aspect” of scientific literacy; i.e., the degree to which science education actually helps people solve personally meaningful, everyday problems and as well make important science related decisions.

3. Educational Purposes of Science and Technology

The goal of science education according to (Feinstein, 2011) should be to help students become competent outsiders “with respect to science and technology; i.e. teach them how to recognize moments when scientific and technological information would be useful and enable them to locate it, integrate it with their own experiences, and reach an informed opinion or decision. He alleges that traditional education instead produces marginal insiders, whose scholastic experiences and rudimentary understanding of science often dampen their interest and impede their confidence in dealing with scientific information.

In a review of the history of science education, Deboer (2000) concluded that although the concept of scientific and technological literacy is

a general one and has varied overtime, it usually implied a broad and functional understanding of science and technology for general education purpose as opposed to preparation for careers in the sciences and technology which brought about the suggestion of a pragmatic approach that embraces science and technology education as

- i. a cultural force in the modern world
- ii. a preparation for the world of work
- iii. a direct application to everyday living
- iv. teaching students to be informed citizens
- v. a particular way of examining the natural world
- vi. understanding reports and discussions of science that appear in the popular media.
- vii. learning about science for its aesthetic appeal
- viii. preparing citizens who are sympathetic to science
- ix. understanding the nature and importance of technology and the relationship between technology and science.

4. Quality Assurance of Science and Technology Education

The concept of quality in education addresses the practitioners input and output in it's entirely. Quality in education according to (Mosbi, 2005) is considered as baseline standard in education, which can be measured on a scale of preference. Standards imply accepted principles, rules, guidelines or level established by group of people, organizations or society. Particularly in (Bisong, 2000), educational enterprise has to do with establishing and maintaining standards which form the basis of evaluation.

Quality in education therefore is an expression of standard or it is the means by which a certain set standard in education can be achieved by many factors that exist within the academic system. However according to (Akinbobola and Iktde, 2008), quality assurance can be improved upon in science education by:

- i. Making provision for learning facilities and equipment such as infrastructures, electronic systems, tools and other materials that could be utilized for directing and controlling vocational technical operations thus reinforcing the teaching and learning of specific skills.
- ii. Adequate staffing which will definitely provide the frame work within which teacher workload can be reduced to enhance efficiency and quality.
- iii. Improvement of teacher remuneration beyond what it is presently, as high wages intend to produce commitment and efficiency.

Conclusion:

Education is a social process, it is growth and development and a better safe guard for liberty than a standing army. The future of any nation in the modern world depends to a great extent on the educational system. Science and technology have become crucial factors for sustainable development worldwide as both have contributed immensely to the material progress of nations. They are also necessary for the economic development of nations according to Olagunju, Adesoji, Iroegbu and Ige (2003).

However in line with Ezeliora (2005), the quantity and quality of science and technology education received by the future leaders of the nation depends solely on the effectiveness and efficiency of the science teacher. Low quality teachers and low quality facilities necessarily imply low quality products and low quality performance in the society by such products. Therefore, the quality of science education is affected by policy and contextual factors within the environment, the availability of inputs, the processes and the consumers of the products of science education.

Consequently, national growth and development can only be achieved when science and technology are given prominent attention where the goals and objectives of science at all levels of education should present the core curriculum as a functional science and as well relate it to real world of work.

References:

- Akinbobola, A. O., and Iktde, G.A.: Strategies for achieving quality assurance in science education in Akwa Ibom State, Nigeria. 2008
- American Association of Colleges and Universities AACU: College learning for the new global century. Washington, DC 2007
- Binkley, M., Erstad, O., Herman, J., Raizen, S., Ripley, M., Miller-Ricci, M. & Rumble, M.: Defining Twenty-First Century Skills. In: P. Griffin; B. McGaw & E. Care. (Eds). Assessment and Teaching of 21st Century Skills. (pp. 1-45). London: Springer. 2012
- Bisongs J.O.: Quality and competence teacher in education. In A.M Wochocha (Ed.) Quality in Nigerian Education Agenda Action. Port-Harcourt Osia International Publishers Ltd. 2000
- Choi, K., Lee, H., Shin, N., Kim, S-W. & Krajcik, J.: Re-Conceptualization of Scientific Literacy in South Korea for the 21st Century. Journal of Research in Science Teaching, 48(6), 670-697. 2011
- DeBoer, G. E.: Scientific literacy: another look at its historical and contemporary meanings and its relationship to science education reform. J. Research in Science Teaching 37:582-601. 2000

- Dede C.: Transforming Education for the 21st Century: New pedagogies that help all students attain sophisticated learning outcomes. Harvard University. 2007
- European Commission: Science Education Now: A renewed pedagogy for the Future of Europe. Report by a High Level Group on Science Education. Brussels: author. 2007
- Ezeliora B.: Teacher factor: A challenge to the implementation of primary Science curriculum. Curriculum issues in contemporary education Dasyilva influence. Benin Nigeria. 2005
- Feinstein, N.: Salvaging science literacy. Science Education 95: 168-185. 2011
- Feinstein, P.: Salvaging science literacy. Science Education, 95(1), 168-185. 2010
- Fensham P.: Science education policy making. Paris: UNESCO 2008
- Fernandez, C.; Holbrook, J.; Malmok-Naaman, R. and Coll, R. K.: How to teach science in emerging and developing environments. Teaching Chemistry - A Study book Sense Publishers, 299 - 326. 2013
- Griffin, P., Care, & E., McGaw, B.: The Changing Role of Education and Schools. In.
- Griffin, P., McGaw, B., Care, E. (Eds). Assessment and Teaching of 21st Century Skills. (pp. 1-45). London: Springer. 2012.
- Holbrook J., Rannikmae, M.: The meaning of scientific literacy in Richard K. Coll and Neil Taylor (Eds.) International journal of environment and science education. 4(4), 275-288; 2009
- Lazonder, W., Pascal, W., & Hagemans, M. G.: The influence of domain knowledge on strategy use during simulation-based inquiry learning. Learning and Instruction, 18, 580-592. 2008
- Leitch Review of Skills: Prosperity for all in the global economy- World Class Skills. London, England: Her Majesty's Treasury. 2006
- Levy, F., & Murnane, R.J.: The new division of labor: How computers are creating the next job market. Princeton, NJ: Princeton University Press. 2004
- Mosbi, N.H.: Quality assurance in SEAMEO vocational and technical education and training. A paper presented at the intergovernmental workshop on regional accreditation modeling and accrediting the accreditors at Colombo Plain Staff College Philippines. 2005
- National Research Council (NRC): Exploring the Intersection of Science Education and 21st Century Skills: A Workshop Summary. Margaret Hilton, Rapporteur. Board on Science Education, Center for Education, Division of Behavioral and Social Sciences and Education. Washington, DC: The National Academies Press. 2010.
- North Central Regional Education Laboratory and the Metri group enGauge 21st century skills: Literacy in digital age. Naperville, IL : NCREL. 2003

Olagunju, A. M, Adesoji, F. A, Iroegbu, T.O and Ige, T .A.: Innovations in science teaching for the new millennium In Oluremi Bamisaiye (Eds.) Innovation in theory and practice Macmillan publisher Nigeria 2003
Partnership for 21st Century Skills: A state leader's action guide to 21st century skills. A new vision for education. Tucson, AZ; Author. 2006
Scardamalia, M., and Bereiter, C.: Knowledge building: Theory, pedagogy and technology in R.K, Sawyer (Ed.) The Cambridge handbook of the learning sciences. New York .Cambridge University Press. 2006

INSTITUTIONALIZATION OF GENDER MAINSTREAMING IN NIGERIA'S TERTIARY

Olabisi Idowu Aina, PhD

Gender and Development Studies

Ibiyinka Ogunlade, PhD

Department of Chemistry, Ekiti State University, Ado - Ekiti, Nigeria

Oluwatoyin Olatundun Ilesanmi, PhD

Comfort, Afolabi, PhD

Gender and Development Studies

Abstract

Women have been historically marginalized in all spheres of life including social, economic and political spheres. This anomaly has been recognized globally and it has become accepted that issues of women's human rights are important for any meaningful development to take place. Apart from social justice, which demands equal opportunity for all citizens, it is smart economics to plan with both halves of one's population because it benefits society as a whole. In consonance with this global standpoint, and coupled with Civil Society engagements, the Nigerian government has been overt in engaging in gender responsive policies and programmes, including the development of the National Gender Policy in 2006 which puts credence on strengthening institutions and systems for gender mainstreaming and building partnerships with male led institutions to deliver results for girls and women. The policy recognises gender education as a major pillar in the process of achieving gender equality and women empowerment through transformative development process. Although the process has been somewhat slow, the Nigerian tertiary institutions are now becoming responsive to the engendering process that is, ensuring that academic programmes and the learning environment are gender responsive. Although the gender profile in Nigerian tertiary institutions is still abysmally poor, a number of universities are now adopting gender mainstreaming strategies in knowledge production and in practice. Using Ekiti State University as a case study, the paper presents gender mainstreaming strategies and mechanisms adopted in Nigerian tertiary institutions, noting achievements, challenges and prospects. Basic gender profile of the university is presented, while intervention programmes and initiatives at bridging gender gaps and

institutionalising gender mainstreaming as an administrative tool are processed and analysed.

Keywords: Gender Equality, Women Empowerment, Gender Mainstreaming, Institutionalization, Education Sector

Introduction

Globally, education is fundamental to achieving sustainable social and economic development. No nation has ever recorded phenomena development without credence to educational advancement and inputs of its human population. The vast technological development and innovations recorded in the Western world has been chiefly the products of relentless research efforts and innovative discoveries of great female and male scholars in higher institutions of learning. Though, many-at-times, the great works of female scholars are unannounced compared to their male counterparts, women have made significant input to global developments in the field of education. Education at all levels promotes health, improves the quality of life, expands access to paid employment, increases productivity and facilitates social and political participation for men and women.

In spite of these advantages, comprehensive gender inequalities exist in education especially in most African countries. Even though tertiary education and jobs are currently opened to females and males, there still exists huge gender gaps in knowledge transmission, students' enrolment and staff recruitments, promotions and appointments in Nigeria. Although Nigeria has a total of 138 universities registered by NUC (Federal and State Governments own 40 and 39 respectively; while 59 universities are privately owned), the number of male in tertiary institutions as either students or staff exceeds that of female. Apart from the numerical strength favouring men, the 'tokenism' status of women in Nigeria tertiary institutions further expose women to various types of abuses, including sexual harassments, and poor institutional support for women-focused issues (since the management of these institutions is largely controlled by men who are often insensitive to gender issues). Notably, educational institutions are pivotal in seeing the female population engaging in every facet of sustainable human development. It is therefore important to ensure that these institutions respond positively to the engendering process.

Gender equity gaps in the nigerian tertiary education

Gender inequality pervades the Nigerian higher system in such areas as student enrolment, staff employment, and administrative policies and programmes. Obvious gender disparity is seen in students' enrolment, where the percentage of females in higher education in Nigeria is 39.9% (with most

of these women in the Humanities). The access of females to university education increased from ratio of 1 to 40 (F/M) in the 1950s, to 1 to 4 (F/M) in 2001. Notably, a wide disparity exists in traditionally male dominated disciplines such as the field of Engineering where the ratio is about 1:20 (F/M) (Situation Analysis Report, OAU Ife, 2002). A major theme which is also taken as a norm is the widespread of violence against women within the universities. This could be in form of sexual harassment, and/or violent outburst of cult groups against women, thus making campuses unsafe for girls.

The gender equity gaps in Nigerian tertiary Education system could be traced to pre-colonial patriarchal arrangement whereby predominant occupational skills within the family are transmitted mostly to boys (for example, farming, fishing, carpentry, masonry, black/gold-smithing among others), while skills relating to reproductive functions are transmitted to girls, including house-keeping, and child rearing. Thus, traditionally, skill training was gendered, as there were distinctive gender roles across traditional cultural groups.

Formal religious education in pre-colonial Nigeria was introduced to the Northern States through the spread of Islam and in the South, through the arrival of Wesleyan Christian Missionaries in 1842 in Badagry, in the present Lagos State. The Islamic education was mainly meant to propagate Islamic ideologies (Fafunwa, 1974). Though both men and women were taught to read the Quran, the Islamic teachers were mostly men.

The Christian Mission schools in Southern Nigeria between 1842 and 1914, focusing on 4 subjects - Reading, Writing, Arithmetic and Religion; prepared men for new roles of teachers, pastors, evangelists and interpreters. Most of the early secondary schools were in fact Boys' Secondary Schools (e.g. the CMS Grammar School was established in Lagos in 1859, the Methodist Boys High School also in Lagos in 1878 and Baptist Academy, Lagos in 1885). These schools produced the first set of elites who were restricted to particular locations, and mainly males. These were the people who took over the reins of governance from the British Colonial Government at independence in Nigeria. The entrenchment of Western style education was more difficult in Northern Nigeria as Christian Missionaries and Western Education were rejected by the people. By the time Western education was introduced to Northern Nigeria in 1914 and thereabout, there were already about 25,000 Quranic schools (Mkpa, 2013).

Though, patriarchy in traditional societies thus facilitated inequalities in prestige, power and access to resources (Ezumah, 2000); the colonial government not only laid the foundation of the educational system in Nigeria, but also heralded the distinct gender norms. Even when Girls Secondary School came into existence, the colonial administration

emphasized clerical skills for boys and domestic science for girls in the school curricula. In other words, the educational curricula for girls enabled them to become good housewives rather than to become income earners. This was in line with the Victorian Ideology of the colonial masters which permanently signified the position of women in the 'kitchen', while men dominated the public sphere and its governance beginning with the education sector. Thus, lack of proper education continues to be a strong barrier to female participation in leadership/governance, and employment in the formal sector.

The gender disparity in access to university education and jobs is a replica of the international scenario. As a global phenomenon, the results of a follow-up survey conducted in 2000 by Association of Commonwealth Universities has indicated that women remain disproportionately represented within instructors, lecturers and unranked positions (Singh, 2008). More so, women remain significantly under-represented in tertiary institutions which are in contrast to over representation at primary and secondary schools. Bush (2006) also stressed that women are greatly under-represented in senior positions in education as in many other occupations. He stated that men dominated numerically in senior positions in all phases of education with the exception of nursery and infant schools. In India, Singh (1993) cited by Dines (2008) observed that "women Deans are a minority group and women Vice-Chancellors are still a rarity". Earlier, Dines (1993) reported that men outnumber women at about five to one at middle management level and at about twenty to one ratio at Senior Management level. He also noted that women are more in academic positions than in management positions. The study further revealed that the poor representation of female Professors and female Chief Lecturers at Professorial level result to poor representation at the management cadre. Even at times when women are qualified and available, the institutions are unwilling to take the risk of appointing women to top management positions because of women's multiple roles or dual career conflict between their professional obligations and home/family responsibilities (ref?). Furthermore, Mensah, Biney and Ashang (2009) affirmed that employment pattern in Africa still favours men more than women. Ajayi, Goma and Johnson (1996) found that the percentage of women in tertiary institutions in Sub-Saharan Africa is only 25% of the total enrolment and this is much lower than the secondary level and the latter is much lower than the primary level. Duyilemi (2007) also noted that the percentage of females in the academic sector is still very low and that in tertiary institutions most females are in junior cadre of administration.

Global policy guidelines for bridging gender equity gaps in tertiary institution

The advancement of women's rights to education has been entrenched either directly or indirectly by a number of UN Declarations, Conventions, and Treaties on Gender Equality and Women Empowerment , including:

- The 1948 United Nations Charter and the Universal Declaration on Human Rights which sets the tune for gender equality and women empowerment around the world;
- In 1974, UN declared an International Year of Women, which was globally celebrated by women and ended in Mexico City, Mexico (1975).
- The First World Conference on Women (FWCW) held in Mexico City, Mexico (1975), followed by the Second World Conference on Women (SWCW) held in Copenhagen, Denmark (1980), then the Third World Conference on Women (TWCW) held in Nairobi, Kenya (1985) and lastly, the Fourth World Conference on Women held in Beijing, China in 1995 – all championed the course of gender equality and social justice principles around the world;
- The UN General Assembly landmark Convention for the Elimination of all forms of Discrimination Against Women (CEDAW) adopted in 1979, to which all African States are signatories.
- The creation of UNIFEM now called UN Women allowed institutional recognition to the need for a focused approach to women's empowerment at global and local levels.
- The United Nations (UN) World Conference on Human Rights in Vienna in 1993.
- The International Conference on Population and Development in Cairo – ICPD (1994).
- Through Agenda 21, Women's role was stressed in the Rio commitment which centrally placed women's contribution in environment management.
- UN Millennium Development Goals in particular MDG3 on Gender Equality and women empowerment; and currently by
- The Post-2015 Sustainable Development Goals (SDGs), which also flags 'Gender Equality and Women Empowerment' as a priority goal.

Specifically, in order to bridge gender disparities in higher educational institutions globally, the United Nations, British Council and the Swedish International Development Agency (SIDA) have presented specific gender mainstreaming mandates which affect higher education institutions globally. These include –

a. **The Beijing Platform for Action (BPfA) and the UN Economic and Social Council (ECOSOC):** These enjoin international development community, governments of nations and other actors in development to “promote an active and visible policy of mainstreaming a gender perspective in all policies and programmes so that, before decisions are taken, an analysis is made of the effects on women and men, respectively.”²⁶ The ECOSOC mandate affirmed that “mainstreaming a gender perspective is the process of assessing the implications for women and men of any planes action, including legislation, policies or programmes, in all areas and at all levels. It is a strategy for making women’s as well as men’s concerns and experiences an integral; dimension of the design, implementation, monitoring and evaluation of policies and programmes in all political, economic and societal spheres so that women and men benefit equally and inequality is not perpetuated. The ultimate goal is to achieve gender equality.”²⁷

b. **The 2013 British Council's Going Global Conference** in Dubai reiterated the following conditions for engaging tertiary institutions on the gender equity project -

- **Research Projects:** Part of the stipulations of the Manifesto for Change for Women in Academic Leadership and Research states that "gender implications and impact" of research projects must be included by grant-making bodies as a criteria against which funding applications are assessed.

- **Gender Mainstreaming:** Gender Mainstreaming should be fundamentally incorporated in all of a university's practices and procedures

- **Global Database:** All higher institutions should have a global database on women and leadership in tertiary institutions so that it's easier to see how slowly – or indeed how fast – the situation improves country by country.

c. **The Swedish International Development Agency (SIDA)**²⁸: An influential “think-piece” from Joanna, Thomas and Woroniuk (1996) maintained that

²⁶Platform for Action, Fourth World Conference on Women, Beijing, 1995. United Nations. <www.un.org/womenwatch/daw/beijing/platform/declar.htm>

²⁷ECOSOC. 1997. Agreed Conclusions on Mainstreaming the Gender Perspective into all Policies and Programs in the United Nations System. United Nations. <www.un.org/documents/ecosoc/docs/1997/e1997-66.htm>

²⁸Schalkwyk, Johanna, Helen Thomas and Beth Woroniuk. 1996. Mainstreaming: A Strategy for Achieving Equality Between Women and Men. A Thinkpiece. SIDA Secretariat for Policy and Corporate Development, Economic and Social Analysis Division.

an effective gender mainstreaming strategy should initiate and sustain change processes at the following multiple levels:

- **The organisation itself** – its policies, procedures, culture and people.
- The development interventions supported by the organisation, which lie within the intersection of its own work with the work of its partners.
- The larger national context, including the socio-economic, cultural and political environment in the country (*in this case, the University environment*); the policies and programmes of the development partners; and the perspectives and strategies of the women's movements and other civil society actors.

Nigeria, being signatory to most of the UN Declarations and Conventions on Gender Equality and Women Empowerment; while also involved in a lot of bi-lateral and multi-lateral relationships with a number of Development Partners has been positive in its policy response challenges of gender disparities and inequalities in the various sectors, in particular, the education sector.

Women Education and the Nigerian Policy Environment

Sequel to the adoption of the universal declaration on human rights by UN in 1948 education became a veritable implementation for promoting and achieving gender equity social justice, poverty reduction and the overall advancement of women .

This has opened the door of university education to a lot of women in Nigeria

But in spite of the global policy on education for all which began in 1948, and which gathered momentum in Nigeria since 1990, these efforts are yet to translate to equitable opportunity for the girl child in Nigeria.

Though the Nigeria national gender policy (2006) identified 'gender education' as one of its pillar, the policy is yet to be embraced fully by the state and local government machineries, while educational institutions present very low technical capacity for its implementation (FMWA,2014).

Table 1: Specific Gender Focused Policies and Programmes in the Education Sector in Nigeria

S/N	GENDER FOCUSED EDUCATION POLICIES	Year
Federal Level		
1	Blueprint on Women's Education	1986
2	Nomadic Education Programme	1986
3	National Commission for Mass Literacy and Non-Formal Education	1991
4	Family Support Basic Education Programme	1994
5	Universal Basic Education	1999
6	National Policy on Women	2000
7	Education for All-Fast Tract Initiative	2002
8	Strategy for Acceleration of Girls' Education in Nigeria	2003
9	Child Rights Act (2003) – 13 of the 36 Nigerian States are yet to accede to the Act	2003
9	National Economic Empowerment and Development Strategy (NEEDS)	2004
10	Universal Basic Education Act	2005
11	National Gender Policy	2006
12	National Policy on Gender in Basic Education	2007
13	National Child Policy and Its Strategic Plan of Action	2007/2008
14	The Girl Child Education Initiative in Northern States – FGN/UNICEF	2008
15	The 10-Year education Plan (2006 – 2015) – targets gender budgeting and ensures expenditure framework for closing gender gaps in the education sector	
STATE LEVEL		
1	Laws prohibiting the withdrawals of girls from school in the following Northern states: Gombe, Bauchi, Niger, Bornu and Kano	
2	Rivers State Schools Rights Law No.2	2005
3	Special Scholarship Schemes for females to study medicine in Gombe State, Northern Nigeria	2005

The Nigeria's response to gender gaps in the education sector has principally been at the lower levels of the educational system, that is, primary/secondary schools. Since 1986, there have been numerous educational policies to bridge the gender gaps at the lower levels of educational system, including the Blueprint on Women's education (1986); establishment of the National Commission for Mass literacy and non-formal education (1991); Strategy for Acceleration of Girls' Education in Nigeria

(2003); the Universal Basic Education Act (2004) and the National Gender Policy (2006) (see Table 1).

The Nigeria's response to gender gaps in the education sector has principally been at the lower level of the educational system that is primary/secondary schools. Since 1986, there have been numerous educational policies to bridge the gender gaps at the lower levels of educational system as illustrated in Table 1.

Non- formal approach to gender education

Science and Technology being a vital tool for achieving sustainable national development, an innovative, non formal approach is employed in catching children young for science tagged 'Children Science Clinic'. This is an out- of- school, activity –based and community- linked integrated, workshop approach that presents science as fun to children, aged 5 to 12 years (primary school level) through science playlets, exhibition, quizzes, competitions and excursions to science based industries within the immediate environment. Also children, aged 13-17 years (secondary school level) are exposed to programmes and conferences/talkshops to motivate them, this is tagged Children-in-Science & Technology (CIST). Educators, educationists, scientists, policy makers are gathered annually to brainstorm and formulate policies on various themes to popularize science and technology for self reliance, In all these programmes, girl child is made a focal point.

The skills acquired during these activities enable the children initial ideas to be linked to new experience as discussion of scientific ideas, principles and concepts are handled by professionals as role models, using activity- based and child –to- child approaches. (Ogunlade, 1999, 2003).

Gender assessment of the workshop as regards to the performance of girls and boys when subjected to statistical analysis showed that there was no significant difference on the basis of gender. (Ogunlade, 2012, 2015)

The finding shows that a gender-responsive environment will boost interest in science and technology as a career among school pupils irrespective of their gender group.

This in turn will address gender issues in the Nigerian higher education institutions which have been at a very low pace. Predominantly, these institutions are managed and governed based on androcentric principles, and thereby remain largely gender unresponsive.

Though the number of Universities and Colleges of Education now running courses in Gender Studies are growing, only very few higher education institutions embrace gender mainstreaming as a management tool, and for gender transformative development with implications for structuring/restructuring academic curricula.

Logical framework and mechanisms for instituting gender equity in tertiary institutions: the eksu example

Understanding Building a Gender Equitable Institution

The logic of building a gender equitable organization as a major step to creating greater efficiency and effectiveness in organizations, including institutions of higher learning is gender mainstreaming. Mainstreaming gender into organizations and institutions relies on a number of strategies which could be at both the systemic and the individual (personal) levels.

Four frameworks were proposed for the promotion of gender equity in organizations (kolb *et al* cited in Aina, 2005).

- i. ***Equipping the woman*** – a framework which assumed that the biological difference between men and women in organizations is responsible for women’s lack of requisite training and skills to compete in the workplace;
- ii. ***Creating equal opportunity*** – a framework which assumed structural barriers between men and women in the workplace due to their biological difference, including sex segregation of occupation, and the workplace, perpetuated through methods of hiring, evaluation, promotion processes etc. which tend to create glass ceiling against women. Intervention in this regard is often based on improving the situation of the individual worker (females) through access to opportunities and training;
- iii. ***Value difference*** – this framework focused on socialized differences between men and women, exacerbated in masculine and feminine roles and functions. Unlike frames 1 and 2, these gender differences are to be celebrated rather than deplored; and
- iv. ***Re-vision work culture*** – a framework, which focused on, the underlying systemic factors in organizations that reinforce workplace inequity. In this respect, gender difference is not seen so much in terms of biological differences, but rather, as a social construct which rules the life of the organization. The frame is premised on the fact that organizational systems – work practices, structures, norms, and values etc – tend to reflect masculine experiences, which tend to undermine non-work roles and other responsibilities in the private sphere of life that may compete with work roles and responsibilities. For men and women to be relevant in modern organizations, there is the need to revise social frameworks, which, for long, treated women as ‘outsiders’ within organizations.

The strategic drive of the Ekiti State University to be competitive and enduring amongst its peers locally/internationally, led to a number of innovative programmes which will help meet the development agenda of the university. Part of these, is the creation of the Centre for Gender and Development Studies which aims not only at establishing Gender Studies

academic programmes, but importantly to engender academic and administrative processes of the university. The initiative targets both institutional frameworks and individual interests within the organizational complex. Importantly, the above identified organizational logics informed a number of the organizational processes within the EKSU Gender Equity Initiative.

Gender Equity Initiative in Ekiti State University (EKSU)

Since Nigeria responded to the global clarion call for a gender equality responsive society to fast track sustainable development by adopting the 2006 National Gender Policy, the need to bridge the gender gaps in the knowledge industry has become a necessity. In response to this need, EKSU took a bold step in developing EKSU's Strategic Plan (2014 – 2018) which now drives the process of gender mainstreaming in EKSU. The document is a guide and a re-evaluation tool for the attainment of the University's Vision of becoming a world class institution through services, higher operational and administrative efficiency in the discharge of teaching and research responsibilities.

The University established the Centre for Gender and Development Studies for institutionalizing gender education; and gender equity/justice principles within the EKSU system and the larger society through the establishment of Gender and Development Academic Programmes; engendering of academic disciplines across the university using gender as an analytical tool, and treating gender as a cross-cutting issue in both academic and administrative engagements of the university. Consequently, since its inception in 2013, the Centre for Gender and Development Studies has embarked on the following bold steps towards bridging the existing gender gaps in knowledge production and building a crop of gender experts:

- a. **Collaboration:** Initiated collaboration with the University of Eastern Finland towards improving the quality of teaching and learning as well as the overall development of the Centre is in progress.
- b. **Capacity Building Workshop:**
 - Instructors' Workshop on Gender Pedagogies to flag off the commencement of the Centre's academic programmes at EKSU (January, 2015)
- c. **Academic Programmes:** Commencement of Post-Graduate Academic Programmes for the 2013/2014 pioneer set of students in Gender and Development Studies and Social Work Education. The academic programmes of the Centre include:
 - i. Postgraduate Diploma in Gender and Development Studies
 - ii. Postgraduate Diploma in Social Work

- iii. Master of Science (M.Sc.) in Gender and Development Studies
 - iv. Master of Science (M.Sc.) in Social Work
 - v. Doctor of Philosophy (Ph.D.) in Gender and Development Studies
 - vi. Doctor of Philosophy (Ph.D.) in Social Work
- d. **Research:** The Centre for Gender and Development Studies (CGDS) secured the 2015 TETFund Research grants for the following major research works:
- i. Gender Mainstreaming of Academic Programmes in Ekiti State University: An Action Oriented Study
 - ii. Building Skills in Gender Responsive Pedagogy Among Primary and Secondary School Teachers in Ekiti State: An Action Oriented Study
- e. Up-graded facilities for the 'Centre for Gender and Development Studies', including an expansive 3-Storey Building and IT facilities presently under construction.

Goals and Objectives of the Gender Equity Initiative in EKSU

The primary goal of the gender equity initiative is to institutionalize gender equity and gender justice principles within the university system, thereby ensuring organizational effectiveness and efficiency. The university is therefore poised to create a more egalitarian university environment with deep concern for meeting both the practical and the strategic gender needs of its members – staff and students; and contribute to knowledge production in the Gender Sector. To achieve these goals, the following strategic objectives drive the operations of the Centre -

- a. Mainstreaming gender into the academic and the administrative structures, and the living environment;
- b. Reducing gender disparity in student enrolment, and staff employment through affirmative actions;
- c. Sensitizing staff, students, and the public on gender issues
- d. Building skills and competence in gender mainstreaming across the university
- e. Establishing networks among implementers of the gender equity policy
- f. Strengthening the Centre for Gender and Development Studies (CGDS) to coordinate the implementation, monitoring and evaluation of the gender equity initiative in the university.
- g. Disaggregating by gender all data generated on staff and students across the various units in the university.

Entrenched in the university gender equity principle are the following elements – accountability (a framework which creates gender sentinel sites, and thereby making specific officers accountable for the implementation of the gender agenda); networking (creating a strong internal framework for implementing the gender equity agenda); and cultural values (this necessitates a change of orientation towards equity standpoint in all the organization’s policies and procedures).

Key Strategies and Structure of EKSU Gender Equity Model (EKSU-GEM)

A key component of EKSU-GEM is the institutionalisation of the gender equity principle through organizational transformation. The first step in this regard is defining the vision of the desired outcome, and aligning this to the core strategic goal of the university. The dual agenda of gender equity and organizational effectiveness became a core motivating factor in this process. A key strategy in the gender mainstreaming process is the creation of a ‘Gender Desk’ or a Gender Unit in the Vice Chancellor’s office which then coordinates the gender mainstreaming process within the administrative departments; while the Gender Centre continues to provide technical supports for the engendering process in the university.

It is important to put on record key strategic actions which led to the adoption of a gender mainstreaming mechanism in the university. Some of these are presented below.

EKSU Gender Profile

The first strategic action in the gender mainstreaming process in the university was to conduct a situation analysis survey which helped to document gender gaps across the different units, and in particular, as relating to staffing; student enrolment; and leadership positions. The situation analysis survey helped to document gender disparities in the university’s institutional functioning - which then necessitates the need to bridge gender gaps.

i. Management Positions and Committee Membership

Survey results show gender disparities in staff and students profiles. Most of the senior academics occupying management positions are men. For example, *Figure 1* shows that there are only 10 females out of 99 academic staff in the management positions in the institution. Notably, there is only one female out of the 5 Principal Officers of the University (that is, the Deputy Vice Chancellor – Academics). This trend is however attributed to the recent institutionalisation of gender equity principles in the University,

which makes it mandatory to select at least a woman in one of the 5 most exalted positions in the university governance in Nigeria.

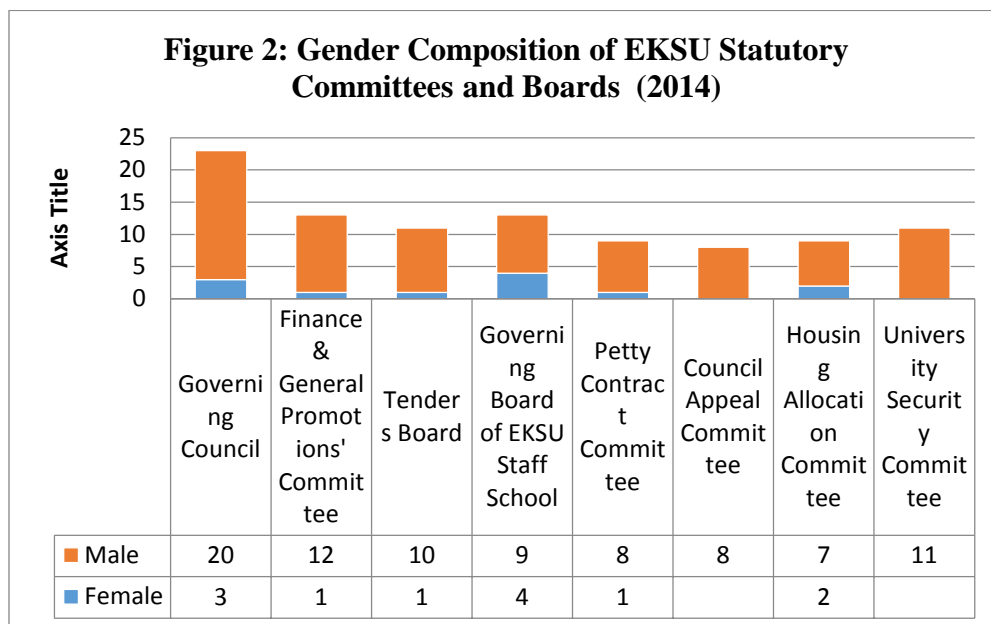
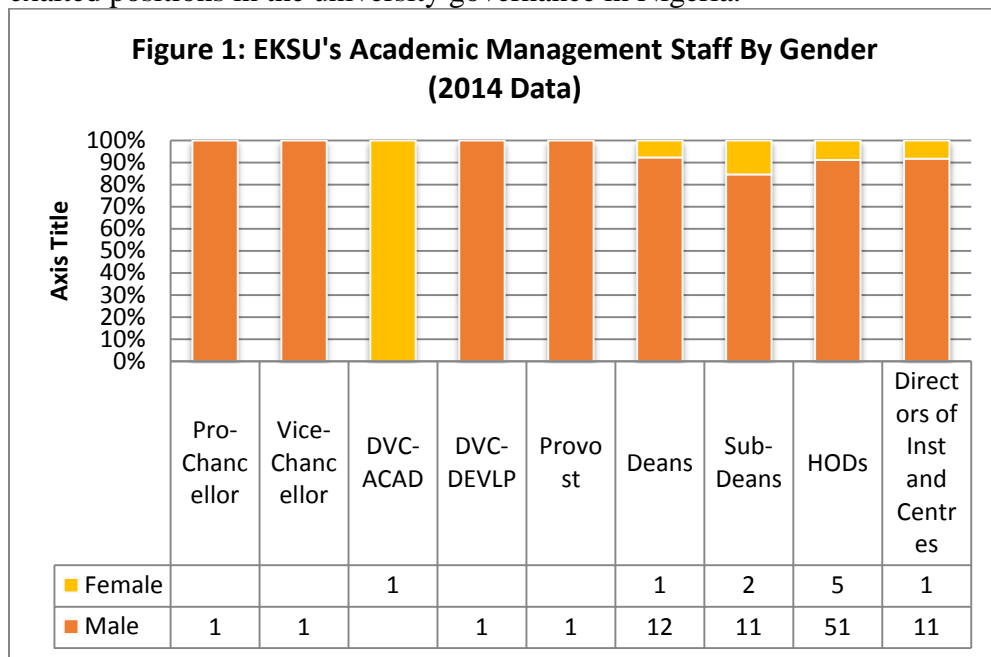

EKSU’s Statutory Committees and Boards are largely filled with males, for out of a total of ninety-seven (97) of such officers, only twelve (12 = 12.3%) are females (see Figure 2). Also, Figure 3 presents the gender profile of the current membership of EKSU’s Senate Committee, which also depicts a huge gender gap. The present Senate Committee has 13 female membership (13 = 9.03%), as against a majority of one hundred thirty-one (131) males (90.9%) (see Fig 3).

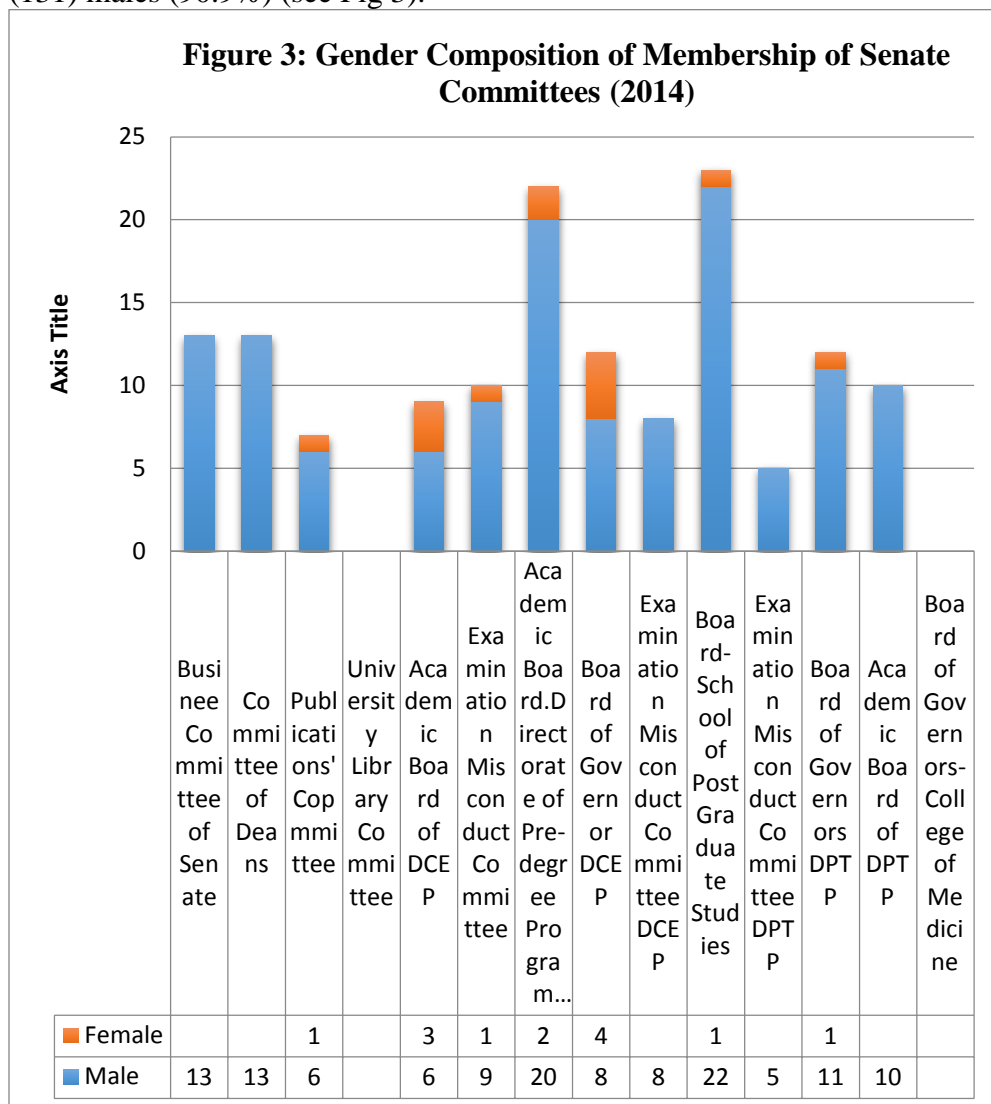

ii. Gender Profile of Academic Staff in EKSU

Figure 4 presents the gender profile of academic staff by cadre, which is skewed in favour of males (also see Appendix 1). Out of a total of 623 academic staff, only one hundred and thirty seven (137) are females (22%).

Gender gap is most pronounced at the highest academic cadre, whereby male professors are 91.3% compared to 8.7% for females. Readers are 78% males, compared to 22% females. It is however impressive that female share of academic staff is gradually increasing at the lower cadres, and in particular, as the least cadre (Graduate Assistants) now records 61.1 females and 38.9 males (although this cadre represents a small proportion of the total academic staff (2.9%). The recent recruitment of female academic staff at this entry level is not unconnected with the gender equity drive within the university and nationally.

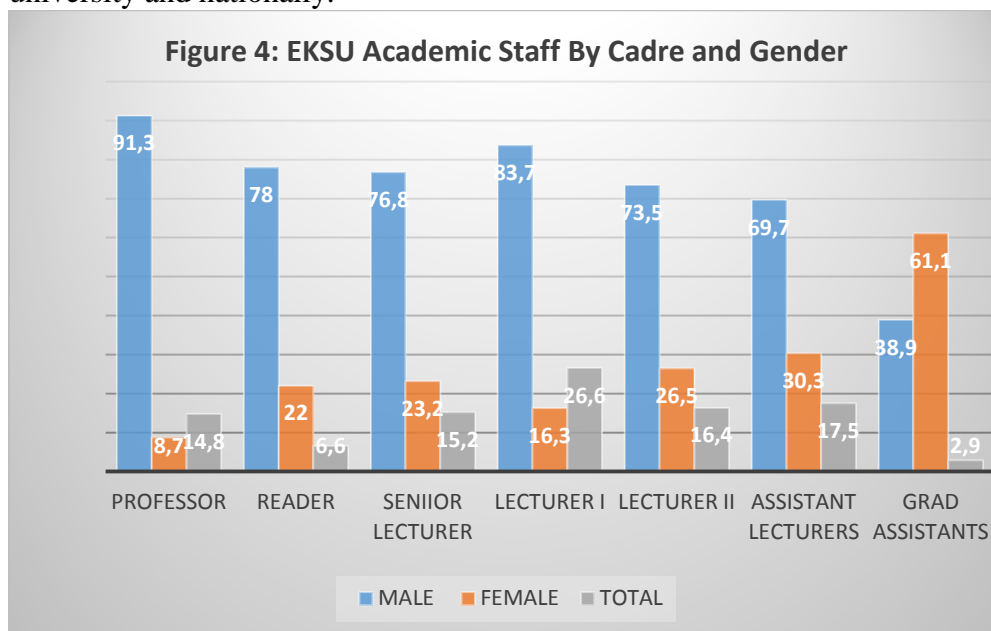

The various data presented above show huge gender gaps in appointments, recruitments, and promotions, while responsibilities for the organisational functioning are largely in the hands of men who occupy most of the senior positions in the university. The policy implications of these gender disparities in staff profiles are many, and therefore deserve policy attention if the gaps are to be bridged in the nearest future. Some of the documented gender gaps have therefore led to actions in the following directions –

- Special support for female academics in the area of research outputs and productivity;
- Ensuring that there is at least a female among the 5 University Principal Officers as a matter of policy;
- Exposing female academics to international conferences and specialised trainings in their respective fields of specialisation in order to enhance their career progression;

- Instituting a gender sensitive recruitment and promotion policies;
- Creating a gender friendly work environment and
- Mainstreaming gender in pedagogies and the learning environment

iii. Gender Disparities in Mode of Entry and Enrolment Figures:

Figure 5 presents a non –gender disaggregated data on students’ mode of entry into Ekiti state University. This means that generally data on staff and students are not routinely disaggregated by gender. Hence, it is often difficult to measure gender gaps. However, with the activities of the new Gender Centre, the university now imbibes the principle of gender disaggregated data. It is part of the activities of the Centre to build capacity in data management responsive to gender needs across the units.

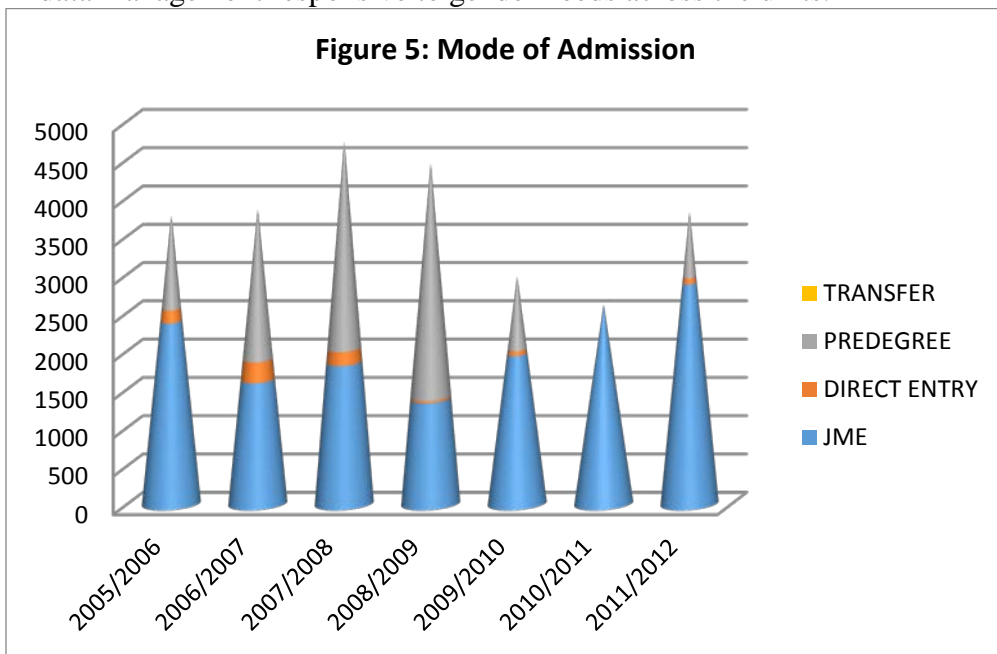

However, Figure 6 presents a gender sensitive enrolment figures, with clear gender disparities in students’ enrolment at the undergraduate levels for seven consecutive academic sessions (i.e. 2005/2006 – 2011/2012 sessions). Overall, the seven year enrolment data indicated that male students had higher admission rate compared to their female counterparts. The 2007/2008 academic session had a slight increase in the number of female students (Females = 2220 & Males = 2512) as against others sessions (e.g. Males = 1356 & Females = 1244 for the 2010/2011 session). This implies that the University management needs to be gender sensitive and responsive towards female enrolment and retention.

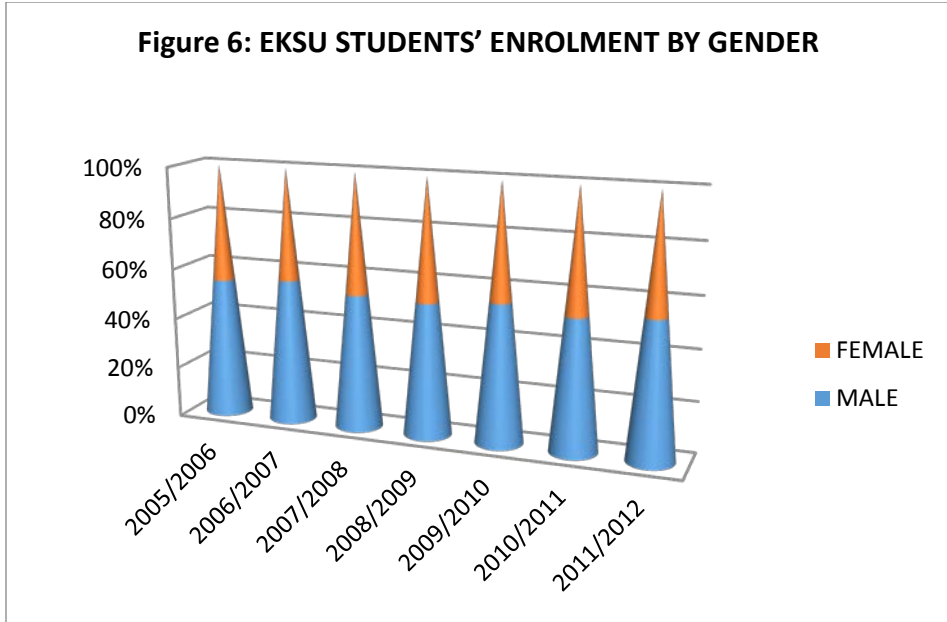

b. Operationalization of EKSU Gender Equity Model

The gender transformation process at EKSU started with a review of the gender situational analysis of the institution. This was closely followed with a gender action plan for mainstreaming gender in EKSU. The staff and students' profiles were examined and used as indicators that could propel the need for change. The indicators are expressed in balanced gender ratios in staff employment, and students' enrolment figures. For example a minimum of 1:3 (F/M) has been suggested by promoters of Affirmative Actions for the attainment of equity; while the National Gender Policy states a 35% Affirmative Action for women/girls in the various sectors of national development. This means that the university must clearly state the gender ratio it intends to achieve within a specified time period. In cases where 50:50 shared ratios are not feasible, a minimum ratio of 1:3 (F/M) is proposed for the University.

The most important factor in creating an enabling environment for EKSU-GEM is the administrative support for the initiative (i.e. a process of legitimisation of gender equity initiative). With a clear support from the University Council (who has responsibilities for policies and laws guiding the operations of the university), a structure was created for the implementation of EKSU-GEM. Each element within this structure has clearly defined roles and responsibilities towards the implementation of the EKSU-GEM (see Figure 7).

Figure 7: The Management System for EKSU-GEM

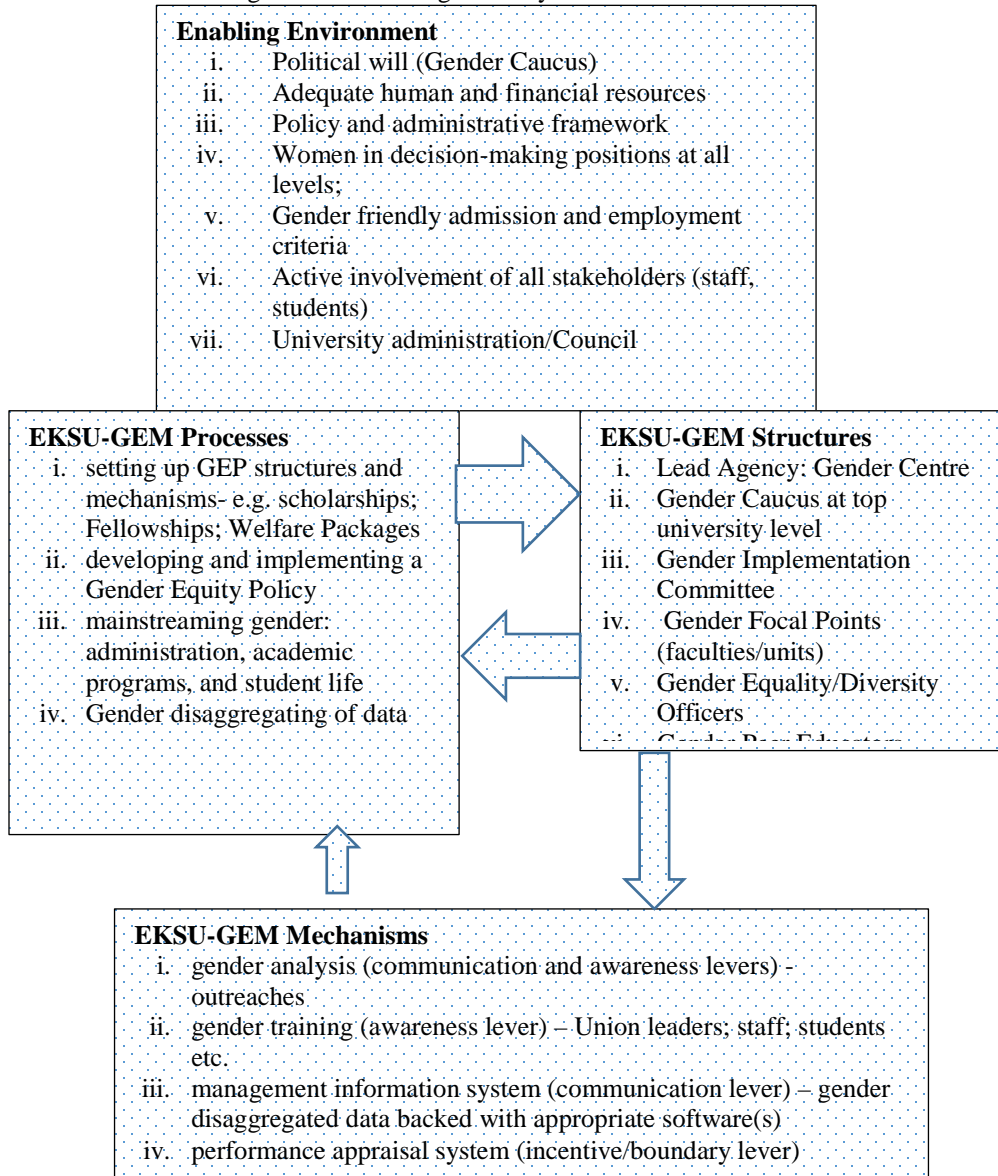

c. Challenges of Operationalization of EKSU Gender Equity Model

As a new Establishment, the following are some of the challenges of the Centre for Gender and Development Studies:

- i. **Inadequate funding:** This has continued to be a major threat to institutionalization of gender mainstreaming in EKSU. Translating gender mainstreaming into all sectors of the University (academics, management, curriculum, employment, students’ enrolments, ICT, health, religious and security) has been inhibited by lack of funds.

ii. Low technical capacity in gender mainstreaming across units (to which the EKSU Gender Centre is currently responding).

d. Operationalization Prospects of EKSU Gender Equity Model

In order to successfully institutionalize the gender mainstreaming agenda in EKSU, CGDS is currently working on the following gender sensitive programmes:

- i. Development of a Gender Equity Policy for EKSU
- ii. Appointment of Equality Advisors and Gender Focal Persons across units
- iii. Establishment of Committee for Equality issues in EKSU
- iv. Scholarships for female indigents students, in particular in non-traditional gender disciplines;
- v. Mentoring of females in male dominated careers and fields
- vi. Continuous Mentoring Workshops and Career Counselling for young female academics.

Table 7 presents key activities in the Centre's current Operational Plan of Action which are to drive the process of institutionalization of gender mainstreaming in EKSU.

	Academic Programmes	Female Administrative and Academic Staff
Planning and Programming	<ul style="list-style-type: none"> • Gender Sensitisation/Awareness Workshops in faculties, Units and Centres; • Mainstream gender issues in academic curricula and administrative processes with the CGDS taking the lead • Linkages/collaborations with Development Partners and Universities abroad to help strengthen the academic programmes in the Gender Centre 	<ul style="list-style-type: none"> • Build the technical capacity of female academics and administrators in requisite areas, including leadership and governance; and on how to attain leadership in research, teaching and community services • Build the technical capacity of a crop of women and men gender champions to ensure sustainability of interest in gender equity issues in the university
Develop Technical Tools and Resources for Gender Mainstreaming in EKSU	<ul style="list-style-type: none"> • Develop Gender Equity Policy for the University with clear guidelines for Affirmative Actions and mainstreaming gender across units <ul style="list-style-type: none"> • Develop Training Manuals, • Conduct TOT on gender analysis/auditing, gender statistics, and gender budgeting among others • Appoint gender Focal Points in various the various faculties, Departments, and Units to support gender mainstreaming. 	<ul style="list-style-type: none"> • Increase female's participation in decision-making processes, including university governance; union activities; and other national level political processes
Strengthen Monitoring and Evaluation (M & E) for Gender Mainstreaming	<ul style="list-style-type: none"> • Monitor/evaluate implementation of EKSU Gender Policy; Gender Mainstreaming of Pedagogies and the Learning Environment; and Students' and Staff overall responses to gender issues and the mitigation efforts 	<ul style="list-style-type: none"> • Fact Sheets on gender transformative efforts at EKSU on a regular basis

Conclusion

Gender education is unique in its ability not only to produce academic knowledge, but a veritable tool for social transformation, and building a just and equitable society of humans (men and women, boys and girls) who together share a common responsibility of making the world a better place. It helps in retooling of theories and research methodologies. Since the advancement of women's rights to education, university education and jobs have been opened to both male and female students and staff although with gross gender imbalance. As part of the efforts to bridge the gender gaps in higher education and jobs, United Nations, British Council and the Swedish International Development Agency (SIDA) instituted a number of treaties and declarations to which Nigeria is signatory. Specifically, the EU Treaty of Amsterdam (1997) and the Beijing Platform of Action (1995) promoted gender mainstreaming as a policy strategy for bridging gender equity gaps. One of the six demands of the 2013 British Council's Going Global Conference in Dubai maintained that gender mainstreaming should be fundamentally incorporated in all of a university's practices and procedures. Consequently, the Centre for Gender and Development Studies (CGDS) conducted a qualitative survey which showed that there is a gross gender gap in the Ekiti State University's management, statutory committee and boards, Senate, Academic staff employment, promotions and leadership positions; as well as students' enrolments and academic attainments. The situation analysis survey present data which gave the Centre a push for its present mainstreaming activities in the university, and relevance.

The importance of the current gender mainstreaming efforts at the Ekiti State University cannot be over emphasised as it continues to build bridges across various divides – male and female staff; staff and students across gender groups and gender interests. Creating a gender sensitive/responsive academic environment is no doubt going to enhance not just institutional functioning, but the performance of staff and students, and more importantly, the females who traditionally were not only marginalised but almost excluded from the seats of power. Galvanising the talents of females for national development, in particular, within the education sector presents a bright horizon for Nigerian economic growth and development.

References:

Adegun, P.T. (2009). The Women Academic and Her Health:Being a paper presented at a seminar organized by National Association of Women in Academics (NAWACS), EKSU Branch,

- Aina, Olabisi I. (2005), Gender Equality in Higher Education in Nigeria: The Case of Obafemi Awolowo University-Carnegie Gender Equity Initiative. *Proceedings of the Women Conference, Australia, Sydney*.
- Aina, Olabisi I. (2013), "Gender equity and higher education in Africa". Lead Paper Presented at the 1st International Interdisciplinary Conference on Gender and Higher Education in Africa: Emerging Issues. *Conference Centre, University Of Ibadan, Ibadan (12 – 13 March, 2013)*
- Ajayi, J. F. A. Goma, L. K. H. and Johnson, G. A. (1996), The African Experience with Higher Education, AAU, Accra in association with James Currey, London and Ohio University Press, Athens.
- Aliu, S, (2001). "The Competitive Drive, New Technologies and Employment: The Human Capital Link". A Paper presented at the Second Tripartite Conference of Manpower Planners. Chelsea Hotel, Abuja
- Bush, T. (2006) Theories of Educational Leadership and Management 3rd Edition, London; Paul Chapman Publishing Ltd. Commonwealth Higher Education. (Unpublished Seminar Paper Presented at Carnegie Gender Workshop, Ghana).
- Dines E. (1993). Women in higher education management Paris. UNESCO/Commonwealth secretariat.
- Duyilemi, A. N. (2007) Girl-Child Education and Empowerment, keynote address presented at Workshop for Senior Secondary School female students Teachers and Education officers in Ondo South West Senatorial Districts Okitipupa. Education Publication.
- Ezumah 2000 perceptions of sexuality and gender relations among the igbo and implications for reproductive health of men and women: selected findings from Awka and Agulu , Anambra state Nigeria in E. Salo and H. Moffett, African Gender Institute Associate Publications 200. African Gender Institute, University of Cape, pp 30-62
- Fafunwa A. Babatunde. The growth and development of Nigerian universities.1974
- Fafunwa A. B.1974. History of education in Nigeria. London: George Allen and Unwin
- Goodall, A. (2009). Socrates in the boardroom: why research Universities should be held. By Mensah, D. O., Biney, I. K., Ashong, G. A. (2009) Gender issues that impinge on access and equity of the masters programme in the institute of Adult Education, University of Ghana, *International Journal of Higher Education research (IJHER)* 1(1).
- Mensah, D. O., Biney, I. K., Ashong, G. A. (2009) Gender issues that impinge on access and equity of the masters programme in the institute of Adult Education, University of Ghana, *International Journal of Higher Education research (IJHER)* 1(1).

- Mkpa M. A. (2013) 'Overview of Educational Development: Pre-colonial to Present day' accessed on www.onlinenigeria.com
- Morley, Louise (2013) *Women and Higher Education Leadership: Absences and Aspirations. Stimulus paper Series*
- Odejide, A. (2001). Women in Management in High Education in Nigeria. The role of academic women's Groups. A Seminar Paper presented on managing Gender Change in *Higher Education* in selected Commonwealth Countries Johannesburg.
- Ogunlade, I. (1999); Catch them young : A philosophy for the development of science in Nigeria.
Published by Corporate Publications pg 19-22
- Ogunlade, I (2005): Non- formal approach to the popularization of science & technology Education in the 21st Century. *International Journal :Science and Technology* Vol.3 no 2 pg 146-149.
- Ogunlade, I.(2012): The Girl-child in the World of Science & Technology. In Potentials for Children in Science and Technology Domain.
- Ogunlade, I.(2015): Food and Education catalysts for sustainable development 41st inaugural lecture, Ekiti State University, Ado-Ekiti, Nigeria.
- Owuamanam, T. O. (2009). The Woman Academic and Her Home: Being a paper presented at a seminar organized by National association of women in academics (NAWACS) University of Ado-Ekiti branch, Ekiti State.
- Schalkwyk, Johanna, Hellen Thomas And Beth Woroniuk (1996). *Mainstreaming: A Strategy For Achieving Equality Between Women And Men- A Think Piece*. Stockholm: SIDA (Department For Policy and Legal Services).
- Shackleton, 2007. Lost in liberalism: a case study of the disappearance of the gender agenda at a South African university. *Feminist Africa* (9), 23-42
- Singh, J. K. S. (2008) *Whispers of Change, Female Staff numbers in Commonwealth Universities* London: Association of Commonwealth Universities. *South African Higher Education*, *Women Studies International Forum*, 29 (6): 572-580.
- Sutherland C., (2008) *Gender Equity Remains a Dream* World Bank Washington D. C. top scholars, Princeton, NJ and Oxford: Princeton University Press.
- Warrigon – Maikama, F. (2003): Promoting Gender Balance and Girl Child Education: A paper delivered at the price giving day of FGGC, Yola. Adamawa State.

Appendix 1: EKSU's Academic Staff Gender Profile By 2013/2014 Academic Session

Faculties	S/ N	Departments	Profess or		Reade r		Senior lecture rs		Lectur er 1		Lectur er 2		Assista nt lecture rs		Graduat e Assista nts	
			M	F	M	F	M	F	M	F	M	F	M	F	M	F
Management Sciences	1.	Banking and Finance (BKF)	1				1		7			1	1		1	2
	2.	Business Administratio n	1								6		2	1	1	
	3.	Accounting			1		1		2	1			3		2	2
Engineer ing	4.	Computer eng.					1				2	1	2			
	5.	Civil Eng.	2				2		5		3	1				
	6.	Elect/Elect Eng.					1		9		2	1	1			
	7.	Mechanical Eng.	2		1		1	1	5		8	1				
Medicin e	8.	Medicine	1				2		4							
	9.	Surgery	3				3		5							
	10.	Med. Bch	1				1		1		1	1				
	11.	Anatomy pathology	1						3							
	12.	Chemical pathology	1						2							
	13.	Heamatology /blood transfusion	1					1		1						
	14.	Med. Mcb & parasiology	1													
	15.	epidemiology			1		1		3	1						
	16.	Community health & anatomy			1											
	17.	dentistry					1		1							
	18.	Obs & gynaecology					1		6							
	19.	radiology					1			1						
	20.	physiology					2									
	21.	pharmacolog y					1		1							
22.	optamology						1	2	1							
23.	anaesthesia							3								
24.	peadiatric							3								

	25.	psychiatry						3								
	26.	anatomy				1		1		3	1					
Arts	27.	Eng & literary studies	2		2		1	1	4	1			4			
	28.	french	1				3		4		2		1			
	29.	History & int. studies	2				1	1	4		1	1	4			
	30.	Linguistics & Nig. languages	1		1		1		2	1		1		2	2	
	31.	philosophy	3		1				2	1	1		2			
	32.	Religious studies	3				3	1	4	1	1		3			
	33.	Theatre & media arts	2													
Agriculture	34.	Agric economics & extension					3	3		4		2				1
	35.	Animal production & health sciences	1		1		1		5		2	1		1		
	36.	Crop soil & environmental science	4		4		4		3	2	1		1			
	37.	Forestry, wildlife & fishery management					1	1	4	1		2	2			
Social sciences	38.	Economics.	1		1				3		2		5	1		
	39.	Geography & planning sciences	3		1		4		2		1	1	1			
	40.	Political sciences.	3		1		4		3		1		1	1		
	41.	Psychology.	1		1		2		1	1			2	1		
	42.	Sociology	2		1	1	1		2	2	1			1		
	43.	Institute of peace, security & governance	1													
	44.	Centre for gender & development studies.		1				1				1				
Education	45.	Curriculum studies	3		3	1	1	1	6		3		7	5		1

	46.	Educational foundation & management	8		1	1	1	4	3	1	3	2	4	4		2
	47.	Institute of education	3			1	2	1		3	1		2	1		2
	48.	Human kinetics health education	2		1		2	1	1		2	2		1		
	49.	Guidance & counselling	4	3	1	1	2	1	3		1	2		2	1	1
Law	50.	private	2				1		3	1		1		1		
	51.	public					3		5	2	1					
Sciences	52.	Biochemistry	2	1		3				1	1	2	2	2		
	53.	Chemistry	5	1	1		3		1	1	3	1	3	1		
	54.	Geology	1		2		2		1		3		7	2		
	55.	Mathematics	3		1		1	1			7	2	8	1		
	56.	Micro biology	2	1	2	1	1	1	1		1		1	3		
	57.	Physics	1	1	1		3		2		3		3			
	58.	Plant science	1		1		2		1	1	4	1				
	59.	Zoology	2				3	1	1	2			2	2		
<ul style="list-style-type: none"> • M = MALE • F = FEMALE 			M	F	M	F	M	F	M	F	M	F	M	F	M	F
			Profess or	Reade r	Senior lecture rs		Lectur er 1		Lectur er 2		Assista nt lecture rs		Graduat e Assista nts			

WEBQUESTS AS A METHOD OF COLLABORATIVE TEACHING

Nazu Shaukenova, MS, ICT in Education
Estearn Mediterrean University, North Cyprus

Abstract

The question of information and communication technologies (ICTs) utilization is very broad and in recent years has attracted several studies especially how it relates to discourses on teaching in higher institutions of learning. Apart from making it possible for students to gain knowledge better, ICTs have proved its relevance for teaching processes too. Through various studies conducted globally, findings show that the level of integration of ICTs in teaching has reached an appreciable level.

Keywords: Collaboration, learning, Web Quest, scaffold, teacher-centered, pupil-oriented

Introduction

Collaborative learning is an approach to teaching and learning, the basic idea of which is that the students gather in groups to jointly solve the problem, the problem of creation of a product. Collaborative learning is based on the idea that the teaching is a natural social act, during which the participants talk to each other. Doctrine occurs in the communication process.

In all situations of real life, when people have to work in a team, it suggests some relationship and interaction between people that identify human abilities, qualities, the contribution of each to the common cause, etc. The underlying premise of collaborative learning is based on the cooperation of members of the group, rather than individual competition, where the person is opposed to the other members of the group.

In an atmosphere of collaborative learning, students have the opportunity to talk with each other, to express ideas, to argue and defend them, share dissimilar beliefs, ask about other than their own point of view, that is, to be actively involved in the learning process.

Collaborative learning can be easily integrated in the class-lesson system in several ways. Some of them require careful preparation (eg, long-term projects carried out by students), while others can be used with little or

no training (for example, the inclusion of for a lecture or an offer to discuss their views with the neighbor).

That the transition to teaching in collaboration forms of educational activities as lectures, notes and listening to the teacher are not excluded permanently and continue to exist in the students' discussions and other forms of active learning activities. Regardless of the method and the number of substituted lectures, the goal remains the same: to get the process with the "teacher-centered" learning "pupil-oriented" training.

At the heart of collaborative learning is the idea that knowledge is socially produced by communities of people and that the teaching is a natural social act, during which the participants talk to each other, that is, the teaching takes place in the communication process. Exchanging ideas, thoughts, feelings, experiences, people processed this information into knowledge, come to understand what is acceptable and meaningful to others in the community. That if a member of the community to learn how to listen and hear his colleagues, he will learn to construct their own knowledge. Thus, using the idea of collaborative learning can solve the following methodological problem:

- Improving the efficiency of learning. The student learns better if he is able to speak, declare, interact with other members of the team;
- Improving literacy of speech and writing. From the ability to speak and communicate with other members of the team depends on the ability of students to write correctly and logically.

In the process of social interaction between students create a learning community of people who possess the knowledge and ready to acquire new knowledge in the process of communicating with each other, the joint cognitive activity. Any member of this community may join the knowledge already created by mankind through communication with more knowledgeable people.

Cooperative learning is more prescriptive than collaborative learning, more controlled by the teacher. That is, cooperative learning, as opposed to collaborative learning, suggests greater structuring activities of students, more guidance and supervision by a teacher for this activity. While collaborative learning is an approach to teaching and learning, the basic idea of which is that the students gather in groups for joint problem solving. Collaborative learning is based on the idea that learning occurs in the process of communication, so the social aspect of this approach is more important than in the framework of cooperative learning.

And you can learn in a different way, when next to you your comrades, who can ask if something is not understood, you can discuss the decision the next task. And if your success depends on the success of the whole group, then you can not not be aware of their responsibility for the

progress and success of your comrades. From the awareness of this fact the authors of teaching in collaboration are repulsed. During training all will do mistakes. Only one needs more time and effort to master the material, other less. How to do it - it is a technique!

Practice shows that learn together not only easier and more interesting, but also much more efficient. And it is important that this efficiency is not for only academic success of students, it concerns their intellectual development, but also moral. Help others to solve any problems together, share the joy of success or failure of bitterness - and of course, how to laugh, sing, and enjoy life.

Web Quest

The main idea of collaborative learning - learning together, and not just something to perform together! These thoughts are the basis of collaborative learning.

Web Quest as an educational tool has recently been widely adopted in the K-16 education. However, its basic principles and functions are not well understood, that led to inconsistencies in practice. This study defines the basic constructs Web Quests perception teachers and the factors influencing their perception. The survey was conducted on teachers recruited from a single large research university in the United States and professional mailings. The results show three designs are perceived by teachers as critical for Web Quests: constructivist problem solving, social interaction and scaffolded learning. The results also show that variables such as goal Web Quest use, years of study, years of using web quests and gender to predict, to varying degrees, the perception of teachers on Web Quests. Talk made on how to structure identified can be used to improve online teaching and learning. Suggestions for further research are included by studying the impact of social, psychological and emotional factors on the learning process of students in Web Quests.

It provides teachers with educational framework to create a meaningful online learning. Well-designed Web Quest contains six steps: Introduction; the problem; information sources; description of the process; evaluation; and an conclusion. Student-centered and inquiry-based Web quest, usually built around a scenario of interest to students, who work in small groups, following the instructions in the Web Quest model. Look for information from the web links provided by the teacher, analyze and synthesize information, and then present the solution to the problem. Students collectively contribute to the understanding of issues of considerable widely and deeply. Continuing formative assessment, which often takes the form of headings used to assess student learning, that aims to help students grow, not only to notice their mistakes.

Web Quest as an effective training tool is characterized by deep assimilation of new knowledge through of critical thinking. Studies show that Web Quest is supported by four main structures: critical thinking, application of knowledge, social skills and skaffolded learning.

The objective of this study was to investigate the perception of teachers and determine the content of Web Quests variables that significantly predicted perceptions of teachers. Thus, the research questions for the study were:

- 1) What factors are perceived by teachers as crucial for Web Quests?
- 2) What variables that affect the perception of such?

To predict the perception of teachers on the web quests were performed hierarchical regression analysis. Four variables gender, goal Web Quest use, years of teaching and years of using Web Quest were used as predictors based on the results of the correlation analysis. In order to predict these variables were introduced: The aim of Web Quest use, Web Quest years use, years of study and gender.

The discussion of the findings was focused on the research questions proposed earlier:

- 1) What are the factors perceived by teachers as critical to the WebQuests?
- 2) What are the variables that affect such perceptions?

The finding implies that teachers believe that teaching critical thinking skills and application of knowledge must be located in a constructivist learning environment that would be "to engage students and require them to solve problems and build skills that are most meaningful to them.

The Web Quest is one of a training model that was acquired by teachers and students for their easiness to design, develop and use in the classroom.

But it is at the same time problems for those who are not able to understand the basic principles of design and web quests, and are also confused about the design and implementation of web quests in teaching and learning. The aim of this study was to identify the constructs in the perception of teachers that put in the model Web-Quest, as well as variables that can affect the perception of teachers on the web quests.

The results of this research have expanded our theoretical and practical understanding of Web Quests.

Theoretically, this research has helped us to reach beyond traditional theoretical basis of web quests and to think about other aspects of web quests as a learning tool. That is, instead of focusing on the components of critical thinking skills and application of knowledge, emphasis is now placed on

constructivist learning, which includes critical thinking and knowledge application.

In practice, the findings offer the opportunity to reflect on current teaching practice Web Quest. For example, instead of having to limit yourself to just the development of interpersonal and small group skills, positive interdependence, individual accountability, and so on, the practice of social cooperation should go beyond its traditional conceptual framework and include skills from other areas, such as knowledge of the application. Therefore, qualified teachers, instructional designers and other professionals in the field of education must recognize the unique features of web quests for the design and development that will benefit students at all levels. Designing and developing Web Quests is a complex process that involves careful planning by putting in perspective all the variables that can affect student's learning, including social, psychological, cognitive, developmental, and so on. In the future, research should be investigated by the relationships among these variables to better understand the complexity of Web Quest learning. Although this study identified three constructs as perceived by teachers critical to Web Quest design and development, further empirical research is needed to validate the constructs in practice.

Our understanding of web quests will be limited if the identification and verification of structures listed applies only to the model of the web quests, without considering the impact of pedagogical and affective factors in learning. Therefore, in future research to expand, to investigate the relationship between the perception of teachers, pedagogy and affective domain.

We can point out such features of web quests is that some or all of the information presented on this site for independent or group work students are actually on different websites. Due to the same active hyperlinks, students do not feel, but work in a single information space for which is not a significant factor in the exact location of a particular portion of the educational information. The student is given the task to collect materials on the Internet by a particular topic, to solve a problem using these materials. Links to sources are part of the teacher, and they can often find themselves using conventional search engines. The completions of the quest are their own web pages on the subject, or some other creative works in electronic, printed or verbal.

It is worth noting that all (from the work process to the scoring criteria) is discussed with the students, in what appears collaboration between students and teachers. By itself, Web Quest presents a list of resources - from teach-yourself up links to sites on the Internet where students will be easier to find the information you need, without getting to third party sites and does not waste time. Work can be carried out in small

groups, which contributes to the formation of active mutual assistance between the students.

Conclusion

In conclusion I want notice that the technology Web Quest is aimed at forming qualities and skills of the 21st century. Activities within the Web Quest involves a creative approach to the task. During this process develops the ability to work together to solve educational problems. Teamwork, responsibility for the result of joint activity is also the result of application of technology Web Quest. Based on the above, we can conclude that the technology Web Quest aims to achieve results that meet the requirements of GEF (global environment facility). Whether it is optimal for the formation of metasubject and universal educational activities? - The controversial issue. The success of the use of technology Web Quest in the educational process depends on many factors. One of them is teacher professionalism, his creativity.

References:

- Guangtao Xu, Xiaoxiong Xu. Qualitative Research of Web-based Collaborative Inquiry Learning in Higher Education. College of Education, Ningbo University, Ningbo, China, 2011.
- Kamisah Osman, Aty Muyassaroh, Lee Tien Tien. WebQuest in Biology Learning: Evaluation of Teachers' Perception. Faculty of Education, The National University of Malaysia, 2013.
- Yasemin Gülbahar, R. Orcun Madran and Filiz Kalelioglu. Development and Evaluation of an Interactive WebQuest Environment: "Web Macerasi". Department of Computer Education and Instructional Technology, Baskent University, Ankara, Turkey, 2010, 139-150.
- Zheng, R., Perez, J., Williamson, J., & Flygare, J., Web Quests as perceived by teachers: implications for online teaching and learning. Department of Educational Psychology, University of Utah, Salt Lake City, UT, USA, Department of Teaching and Learning, College of Education, University of Utah, Salt Lake City, UT, USA, 2007.

THE EAST AND WEST TRUST DEFICIT IN MOHSIN HAMID'S *THE RELUCTANT FUNDAMENTALIST*

Ms. Uzma Imtiaz, PhD Scholar

National University of Modern Languages, Pakistan

Abstract

After fourteen years of the September 11 attacks, the international political landscape is still occupied with suspicion, confrontation and distrust. This study intends to explore the trust deficit between east and west as depicted by Mohsin Hamid in his novel *The Reluctant Fundamentalist* by Mohsin Hamid, and examine how far and how successfully he has portrayed the impact of 9/11 events on the Americans and the Muslims. By comparing the silent American (West) with Changez (East), Hamid has brilliantly discussed the relations between East and West. By revealing the conflicting viewpoints of the Americans and that of the Muslims, Hamid describes how East and West are similar or different in terms of the ideological meanings and sociopolitical situation. In order to make the comparison, I intend to apply the theoretical apparatus of Jean Baudrillard and investigate the extent to which Mohsin Hamid has portrayed the conflict between East and West in his novel, *The Reluctant Fundamentalist*. Since the research method is qualitative, the most appropriate method is the Critical Discourse Analysis model by Fairclough. In addition to East and West rift, the author also throws light on the political milieu after September 11 attacks, including Pakistan-India issue and Afghanistan war as illustrated in the novel. This study, conducted as literary research, concludes that how successfully Hamid attempts to bridge the gap between east and west when he portrays them walking together in the same direction without any violation. However in the current political milieu the clash is between East and East when ISIS and the Taliban from East are attacking the eastern countries on a larger scale.

Keywords: Post 9/11 situation, Distrust, Political milieu and terrorism

Introduction

In order to combat terrorism and weapons of mass destruction after the 9/11 attacks, the U.S. government decided to form a new foreign policy.

President Bush made a speech to the joint session of Congress on September 20, 2001. He said,

We will pursue nations that provide aid or safe haven to terrorism. Every nation, in every region, now has a decision to make: Either you are with us, or you are with the terrorists. From this day forward, any nation that continues to harbor or support terrorism will be regarded by United States as a hostile regime.

The Bush doctrine of 'Us and Them' after the 9/11 attacks fuels the rift between East and West. This paper intends to explore the 9/11 events, their aftermath in the form of suspicion and lack of trust between East and West as portrayed in *The Reluctant Fundamentalist* by Mohsin Hamid. It also aims to examine how the non-Muslims and Muslims are simultaneously affected by the September 11 events, especially when he compares the silent American (West) with Changez (East) and brings them together in the end.

The students and researchers who want to conduct research in the genre of post 9/11 literature can use this study as a frame of reference. Further research can also be done contrasting the movies with the books to analyze alterations in the visual representation of the storyline.

Main Body

In order to analyze Mohsin Hamid's *The Reluctant Fundamentalist*, I need to first discuss the impact of the catastrophe of 9/11 attacks on literature, film and the geopolitical situation. Different movie-makers and writers from diverse religions and regions interpret the 9/11 events according to their own perceptions. Films like "Khuda Kay Liye" by the Pakistani director Shoaib Mansoor "My Name is Khan" by Indian director, Karan Johar, and "Fahrenheit 9/11" by Michael Moore, are filmed according to the discernments of the movie-makers. Similarly some writers, especially the American writers directly represent the catastrophe by portraying the images of the falling towers, falling people from the towers, dust and smoke in the streets of New York, hence the immediate effects of the attack are illustrated in their writings, whereas novels by Muslim writers portrays racial discrimination and prejudiced attitude towards Muslims. They indicate how living in America after 9/11 attacks becomes hard for anyone with a Muslim background.

The geopolitics of the world has changed and is changing soon after the events of September 11, 2001. With the intention of changing the international order, the global aims and priorities are also changing Douglas Kellner in an article titled, "September 11, Terror War, and the New Barbarism" states, "In the context of U.S. politics, September 11 was so far-reaching and catastrophic that it flipped the political world upside down, put

new issues on the agenda, and changed the political, cultural, and economic climate almost completely overnight.”

The United States formed new foreign policies against terrorism that lead America to attack Afghanistan in order to destroy al-Qaeda’s camps and Iraq to eradicate Weapons of Mass Destruction (WMD). The 9/11 commission report states, “Secretary Powell said the United States had to make it clear to Pakistan, Afghanistan, and the Arab States that the time to act was now” (Kean, 2001, p.330).

Research Design

The research design for this study is qualitative and the focus is a novel written in the aftermath of 9/11, i.e. *The Reluctant Fundamentalist* by Mohsin Hamid, a Pakistani Muslim writer. The events of 9/11 engendered trauma throughout the world especially in the US, therefore trauma and terrorism are core topics in most post 9/11 novels.

Since I am working on the trust deficit between east and west, which is the repercussion of the 9/11 terrorists attack, I have referred to Jean Baudrillard, the French political theorist. Baudrillard, in his book, *Spirit of Terrorism* blames the United States (West) for the 9/11 attacks when he states, “By seizing all the cards for itself, it forced the Other to change the rules. And the new rules are fierce ones, because the stakes are fierce” He believes that the 9/11 terrorists have introduced a new kind of terrorism in which they have used all the latest technology and media networks of the Super Power, in combination with their own deaths, to which the dominant power cannot fight back.

Textual Analysis

Since my article deals with the events of 9/11 and its immediate aftermath in *The Reluctant Fundamentalist*, Fairclough's model for Critical Discourse Analysis is used to analyze the novel. Norman Fairclough, in his book *Language and Power* provides three elements of discourse, i.e., “text, interaction and social context” to the three stages of discourse analysis – “description of the text, interpretation of the relationship between text and the interaction; and explanation of the relationship between interaction and social context” (1989, p.109). For this research, I shall be focusing only on interpretation and explanation stages, because the first stage is outside the parameters of my study.

A. Interpretation (of the text by the discourse participants)

In the interpretation of texts, Fairclough poses the following questions:

- 1) “What’s going on? (Topic, purpose)
- 2) Who’s involved?

- 3) In what relation?
- 4) What's the role of language?" (1989, p.146)

B. Explanation

According to Fairclough, this portion deals with the effect that discourse has on practices, whether they are changed or sustained. Thus, explanation deals with social determinants, ideologies and their effects (1989, p. 166).

The Reluctant Fundamentalist: An Analysis

The Reluctant Fundamentalist by Mohsin Hamid portrays the world, after September 11 attacks, from two conflicting viewpoints; one is of the Muslims and the other is of Non-Muslim Americans. Hamid gives a metaphorical touch to his novel by associating Changez with East and the silent American with West. Although it is a post 9/11 novel, Hamid, through his narrator, Changez, discusses many things that are before the 9/11 events and even before the partition of India and Pakistan.

This monologue is narrated to an unnamed American by Changez, a bearded American returned Pakistani man, when the American by chance or by intention meets Changez in one of the restaurants of Anarkali, old market of Lahore. Changez tells him about his experience in America, his entry in an Ivy League school, his employment at Underwood Samson & Company, his pride for earning the handsome salary of eighty thousand dollars per annum. Changez also tells the unnamed American the circumstances in which he decided to come back.

Connotation of East and West in *The Reluctant Fundamentalist*

The events of 9/11 turn American dreams into American nightmares. Changez is in Manila when September 11 occurs, initially he thinks it is a fiction and then he realizes that it is not a movie but reality. Initially he is pleased to learn about the attacks since he believes that it is just that somebody has brought the super power "to her knees" (Hamid 43). He narrates the story to the American listener, however after seeing his hand tightening into a fist with the evident revulsion in his face, Changez tells him quickly that he is no sociopath who does not have any feelings to the sufferings of others. He admits his own sense of perplexity and pleasure at the slaughter of thousands of innocent people. Changez' reaction to 9/11 explores the personal and political side of Hamid: how Changez is pleased to hear about the attacks on American hegemony whereas he is so sensitive about the sufferings of others that even movies give him a twinge of pain.

On the other hand soon after the 9/11 attacks America reshuffled its foreign policy and decided to start War on Terror against all those nations who gave safe haven to the terrorists. The Taliban declined to hand over

Osama bin Laden to U.S without having any evidence of being involved in the September 11 attacks. In response to this the United States along with its allies decided to wage war against Afghanistan in October 2001, that disenchanted Changez from America who was shocked to see the footage of American troops landing in Afghanistan. Different incidents of sanctimonious rage of Americans and FBI's raiding mosques, shops and even houses make him more upset and retaliate against America.

“On a Mission”: Distrust against Each Other

EXCUSE ME, SIR, but may I be of assistance? Ah, I see I have alarmed you. Do not be frightened by my beard: I am a lover of America. I noticed that you were looking for something; more than looking, in fact you seemed to be on a *mission*, and since I am both a native of this city and a speaker of your language, I thought I might offer you my services. (Hamid, 2007, p.1)

The very beginning lines of the novel reflect that Changez and the silent American do not trust each other. In fact they have doubts against each other, the words “alarmed you” that Changez uses while talking to an American reflect that the American startles to see Changez, while when Changez asks him about the purpose of his visit shows his concern. Yet Changez tries to comfort him by offering his services to him and showing him his affection for America.

On May 16, 2007, Aparita Bhandari inquired Hamid in an interview, “The changed man” that how he created a one-person narrative, to which he replied:

Well, it's this dramatic monologue where this Pakistani man is speaking to this American man [and they are suspicious of each other]. I like that frame, because it parallels the way the world looks at each other. Pakistan, or the Muslim world, looks at America and the West, and wonders exactly that: Are you out to get us? Are you a bunch of completely aggressive maniacs or are you people we see on *Seinfeld* and *Friends*? Similarly, America wonders that about the Muslim world: Are you a bunch of terrorists, or just regular people with families and kids? That sense of ambiguity, or not knowing, I think, is what the frame allows me to capture.

The American Policies breeds suspicions and misapprehensions between the individuals of the two countries, especially after the invasion of Afghanistan. When Taliban and al-Qaeda went into hiding in the northern areas of Pakistan, the U.S. Government had thrown thousands of missiles in these areas, in order to kill the militants and in retaliation there had been a

number of suicidal attacks in Pakistan killing thousands of innocent civilians, including children and women. Thus these U.S drone attacks in Pakistan build up resentment among the people of Pakistan at a larger scale.

“You Guys”: Transnational Politics

Although Changez realizes that Erica, his girlfriend, is still in love with Chris, her childhood boyfriend; he still is in love with her. The pointless love and frustrated efforts at intimacy of Changez for Erica reflects that how East and West can move together in parallel directions but cannot meet or intersect. Similarly America after providing a larger amount of financial aid to Pakistan, set up their air bases in different areas of Pakistan with overflight permission. Pakistan was also forced to provide information to FBI about the suspected terrorists and help the US government to arrest Taliban and al-Qaeda, who hide themselves in the northern parts of Pakistan.

Similarly Changez gets offended when Erica’s father gives negative comments about the political situation of Pakistan.

Economy’s falling apart though, no? Corruption, dictatorship, the rich living like princes while everyone else suffers. Solid people don’t get me wrong. I like Pakistanis. But the elite has raped that place well and good, right? And fundamentalism. You guys have got some serious problems with fundamentalism.[Sic] (Hamid, 2007, p.33)

By saying “You guys” Erica’s father demarcates himself (West) from East. Changez does not like the discussion, however he controls his response and defends his country, “Yes, there are challenges, sir, but my family is there, and I can assure you it is not as bad as that” (Hamid, 2007, p. 33).

“Coterie’s concept of American interests”: Changez’ Reaction at War on Terror

As a reaction to 9/11 attacks America decided to attack Afghanistan. American fighter planes began their bombing in Afghanistan. The landing of American troops in Afghanistan shocked Changez, especially when the newscaster calls the intrusion of the U.S forces as a bold step to attack on the command post of Taliban. Changez does not like the American strategy of ‘War on Terror’ and said that instead of targeting the specific terrorist networks, America invaded Afghanistan and Iraq. He reasons:

A common strand appeared to unite these conflicts, and that was the advancement of a small coterie’s concept of American interests in the guise of the fight against terrorism, which was defined to refer only to the organized and politically motivated killing of civilians by killers *not* wearing the uniforms of soldiers... This, I reasoned, was why America

felt justified in bringing so many deaths to Afghanistan and Iraq, and why America felt justified in risking so many more deaths by tacitly using India to pressure Pakistan. (Hamid, 2007, p.108)

Changez believes that majority of the people in America did not want the killings of the deaths of thousands of innocent civilians, including women, men and children by attacking this region. Changez criticizes America for asserting its hegemony in the Middle East since WWII. The American supremacy, with its constant intervention in other nation's affairs, especially Asia, has drastically damaged the world. He also tells the American that America engenders all the major conflicts and confrontations in the Middle East, the straits of Taiwan, Korea, Vietnam and now Afghanistan (Hamid, 2007). This hegemonic attitude of the Super Power makes him happy when he watches the attacks on World Trade Center.

Baudrillard also believes that it is the hegemonic attitude of the Super Power that engenders 9/11 catastrophe. In his book, *The Spirit of Terrorism*, he states: "For it is that superpower which, by its unbearable power, has fomented all this violence which is endemic throughout the world, and hence that (unwittingly) terroristic imagination which dwells in all of us.[sic]" (2003, p. 4-5)

Changez also complains America for not being supportive of Pakistan in India-Pakistan issue, in spite of the fact that Pakistan had given assistance to America, in Afghanistan. He feels powerless at this point of the tension between India and Pakistan.

The post 9/11 America becomes a hard place to live in for the Muslims. Changez decides to go back to Pakistan and does not want to serve America anymore. He quits his job after telling the vice President that he does not want to work anymore for Underwood Samson and left. His colleagues start looking at him with suspicion when he leaves the post in mid assignment and consider him a terrorist, who wants to kill them,

I realized how deep was the suspicion I had engendered in my colleagues over these past few - bearded and resentful - weeks; only Wainwright came over to shake my hand and say farewell; the others if they bothered to look at me at all, did so with evident unease and in some cases, a fear which would not have been inappropriate had I been convicted of plotting to kill them rather than of abandoning my post in mid-assignment. (Hamid, 2007, p. 97)

Even the guards look at him with suspicion when he is leaving the office building with watering eyes. Here again West looks at East with suspicion and have complaints against each other. Hamid believes that Changez is in a challenging space between East and West where the

American capitalism and terrorist attacks reshuffle the international world order.

“Where I Belonged”: Nostalgia

Hamid portrays Changez as a confused personality who is filled with nostalgia for a ‘lost’ Pakistan when he is in New York and thinks about the happy moments he had spent in Pakistan; and for a ‘lost’ America when he comes back to Pakistan after the 9/11 catastrophe. He is also going through nostalgia when he describes his American attire to the American stranger that he looks like a true New Yorker. The exciting memories of Princeton and the Underwood Samson are unforgettable for him and fascinate him when he thinks about them. All these delightful memories filled him with nostalgia.

Changez' nostalgia for the New York City and his personality as a New Yorker is described at various pages in the novel since he still seems to be in love with the city,

I was, in four and a half years, never an American; I was *immediately* a New Yorker. What? My voice is rising? You are right; I tend to become sentimental when I think of that city. It still occupies a place of great fondness in my heart, which is quite something, I must say, given the circumstances under which, after only eight months of residence, I would later depart. (Hamid, 2007, p.20)

When Changez is in Valparaiso for the evaluation of the company, the city reminds him of Lahore because it had been a lively hub of trade before becoming “peripheral” (Hamid 87).

Conclusion

This study, conducted as literary research, concludes that Hamid has brilliantly presented the rift between East and West when he portrays the American as West and Changez as East. In addition to it, Hamid illustrates how at different times, Changez had bitter experiences in post 9/11 America, such as intimacy with Erica, Erica’s father’s comments on Pakistan’s political situation, experience of prejudice at the airport and in a street and above all, his colleagues’ reaction when he leaves the job. It reflects that this country of the “Philosopher-Kings” (Hamid, 2007, p.2) is not perfect and it is as prejudiced towards the cultural and racial differences as any other society or culture.

Hamid’s description of the situation in America and then in Lahore when the American follows Changez either to assassinate him or arrest him to take him to the United States questions West’s response to the East in the post 9/11 era. Although according to Hamid they do not show trust on each

other, Changez gives a positive gesture, “You should not imagine that we Pakistanis are all potential terrorists, just as we should not imagine that you Americans are all undercover assassins” (Hamid, 2007, p. 111). He also shows his closeness towards the American when he tells him about a metal gleam in his pocket, “you and I are now bound by a certain shared intimacy, I trust it is from the holder of your business card” (Hamid, 2007, p.11).

However I believe that when the two walk together in the same direction they show that they want peace and togetherness and not a rift between East and West. By the end of the story Hamid bridges the gap between East and West when he portrays them walking together in the same direction without any violation.

Since the novel leaves a lot of space for interpretation, it can also be said that East only speaks as shown in the character of Changez, whereas West believes in action on the name of War on Terror, such as Afghanistan War and Iraq War. However, in the current political milieu the clash is between East and East when ISIS and the Taliban are attacking the eastern countries on a larger scale. Now it is not the lack of trust on East or West, this distrust is hovering around our heads all the time when we, the Pakistanis, cannot move freely on our roads and have to pass through security checks when armed young men with alert, suspicious eyes after checking the car with a stick with sensors, looked into each car on the name of public’s security.

References

- Baudrillard, Jean. *The Spirit of Terrorism*. New ed. London: VERSO, 2003. Print.
- Bhandari, Aparita. "Changed Man. Mohsin Hamid's Reluctant Fundamentalist Explores Post 9/11 Tension (Interview)." *Changed Man. Mohsin Hamid's Reluctant Fundamentalist Explores Post 9/11 Tension (Interview)*. N.p., 16 May 2007. Web. 25 July 2015.
- Burki, Shahid Javed. "[OPINION] Pakistan after 9/11." *[OPINION] Pakistan after 9/11-Today's Zaman, Your Gateway to Turkish Daily News*. N.p., 8 Sept. 2011. Web. 25 July 2015.
- Fahrenheit 9/11*. Dir. Michael Moore. 2004. Lions Gate Films, 2004. DVD.
- Fairclough, Norman. *Language and Power*. London: Longman, 1989. Print.
- Hamid, Mohsin. *The Reluctant Fundamentalist*. UK: Hamish Hamilton, 2007. Print.
- Kean, T. H., Hamilton, L. H., Ben-Veniste, R., Kerrey, B., Fielding, F. F., Lehman, J. F., Thompson, J. R. (2002). *The 9/11 commission report: Final report of the national commission on terrorist attacks upon the United States* (Authorized ed.). New York: W.W Norton.

Kellner, Douglas. "September 11, Terror War, and the New Barbarism." N.d., Web. 25 July 2015.

Khuda kay liye (In the Name of God). Dir. Shoaib Mansoor. 2007. Geo Films, 2007. DVD.

My Name Is Khan. Dir. Karen Johar. Dharma Productions, 2010. DVD.

"Our Leader- Musharraf: President Address to the Nation." *President Address to the Nation 19 Sept 2001/ Our Leader*. N.p., 13 July 2006. Web. 25 July. 2015.

ECOTRANSLATION: A JOURNEY INTO THE WILD THROUGH THE ROAD LESS TRAVELLED

Guillermo Badenes, Professor and researcher.

Josefina Coisson, Professor and researcher.

Universidad Nacional de Córdoba/Facultad de Lenguas, Argentina

Abstract

How and when are ecological values born? Which is the human perspective of the natural world and how is this conveyed through language? How are current environmental issues represented and subsequently transmitted through translation into new cultural spaces where other values prevail? As a cultural construct, ecology is an interdisciplinary aspect of environmental studies, which have gradually pervaded and affected various (if not every) domain in culture over the past fifty years. This same period has witnessed the development of translation studies and their subsequent shift towards the cultural studies. Considering that translation is in itself the epitome of cultural transference, and it is thus a crucial discipline in the realm of the ecological movement, this paper aims at looking into the complexities of transnational environmental relationships established by translation and exploring how established models can be torn down and rules can be rewritten through paradigm shifts generated by means of translation. Thus, we have structured our work in four main sections: ecological thought throughout history, the language of nature, ecocriticism, and ecotranslation. The latter, as a linguistic ecological practice, is illustrated by three case studies. Our objectives arise from the fact that we have surveyed much literature where, owing to different reasons including the historic period in which the translation was made, mistranslations have silenced the voice of nature. We believe that uniting ecology and translation may present a new approach to translating, contribute to foster debate on ecological issues, and eventually raise awareness and generate change.

Keywords: Translation, ecocriticism, ecology, ecotranslation

Introduction:

As a cultural construct, ecology is an interdisciplinary aspect of environmental studies. Similarly, translation is in itself the epitome of cultural transference. Over the past fifty years, and as a result of crucial

works such as Rachel Carson's 1962 book *Silent Spring*²⁹, which synthesized many environmental concerns existing in society at the time, environmental studies gained momentum and a certain perspective, pervading and affecting various (if not every) domain in culture. This same period has witnessed the development of translation studies and their subsequent shift towards the cultural studies. This paper aims at looking into the complexities of transnational environmental relationships established by translation – and its resulting work – and exploring how established models can be torn down and rules can be rewritten through paradigm shifts generated through language.

Environmental studies and translation studies are interdisciplinary, academic fields. When they come into contact, a series of unresolved matters intersect: How ecological values are deemed; which is the human perspective of the natural world and how this is conveyed through language, and how current environmental issues are represented and subsequently transmitted through translation into new cultural spaces where different notions about the environment prevail. Unlike what has occurred in other translation areas that center around the political relations and stances of translators and their critics – such as feminist, postcolonial, black or queer translation – there are virtually no works discussing the voice of nature and the way it may be silenced (or revealed and discovered) through translation.

Likewise, it is noteworthy that in spite of the political weight of environmental thinkers and the political correctness movement pervading other realms of culture, translation has not quite become an area of interest for ecology yet.

We believe that uniting ecology and translation – presumed divergent fields so far – may foster debate on ecological issues, contribute to raise awareness, and present a different way to tackle translation. Our objectives arise from the fact that we have surveyed much literature where mistranslations have silenced the voice of nature. We believe that translation may facilitate or hamper communication, and we trust that the best way to continue building bridges is learning the engineering and the architecture of language: Its structure and its beauty.

²⁹ *Silent Spring* is a book written by Rachel Carson published in 1962 warning about the harmful effects of pesticides on the environment and blaming the chemical industry of the growing pollution. While many scientists dismissed it as unrealistic, others consider it the first serious work on ecology and it has become a classic on ecological awareness.

Those who supported the author were able to have the United States Department of Agriculture revise its policies on pesticides and ban DDT by law.

In 2006, *Silent Spring* ranked in the top 25 most influential scientific books of all times by the editors of *Discover Magazine*

I. Ecological Thought throughout History

From the birth of Western civilization, we have been taught to understand that the role of *man* on earth was that of dominance over nature. In the Bible, when God adorns His creation with plants and animals, He grants Adam the power to name them: “So out of the ground the LORD God formed every animal of the field, and every bird of the air, and brought them to the man to see what he would call them; and whatever the man called every living creature, that was its name” (Genesis 2:19). This anthropocentric vision – justified in the West by canonical texts such as the Bible – has accounted for the most diverse atrocities against nature. *Man* is thus invested with absolute and supreme power over his surroundings by express orders of the Creator.

From Antiquity throughout the Middle Ages, extreme dogmatism contributed to preserving the *status quo* regarding environmental matters based on the premise of the Divine mandate which granted *man* control over the Earth – or at least the parts of it known to him. We may even argue that this zeal to conquer the world in the name of God was what eventually led to the voyages of discovery.

Nature always charmed human beings. As Adam in the Bible, explorers, artists and politicians became eager to label their discoveries. In the 19th century, a young naturalist called Alexander von Humboldt embarked on a five-year journey around Latin America in order to study and classify species unknown in Europe. His scientific method set the grounds for biogeography as it is known today. Influenced by Humboldt, Charles Darwin developed his own work in journeys in South America: He put forth his theories of population growth, the inevitable limitation of food supply and the survival of the fittest as mechanisms of natural selection and biological evolution.

Even though the 20th century brought about the dwindling of religious beliefs in favor of extreme existentialism, attacks against nature still found justification – this time in science – which came to take the place of religion. The revolution in thought of the 1960s gave birth to the ecological movement, which emerged as a social, collective cry in defense of the environment transcending national, religious and class boundaries.

In “The Shallow and the Deep, Long-Range Ecology Movement: A Summary,” Norwegian philosopher Arne Naess (1995) establishes two opposing ecological practices: Shallow ecology, which is mostly concerned with fighting “against pollution and resource depletion [whose central objective is] the health and affluence of people in the developed countries” (p. 3), and deep ecology, where the individual and the universe are a unit and where non-human life has intrinsic value beyond whatever use human

beings can make of it. Naess states that shallow ecology practices and beliefs are rooted in the anthropocentric vision which upholds the human/nature dichotomy based on individual qualities and differences such as reason, which grants human beings a superior status. On the other hand, his ecocentric vision does not distinguish between human beings and all other animal, vegetal and mineral beings. It does not recognize hierarchies between these entities as it believes that the same laws guide all existence on the face of the Earth. In this way, ecology as a science and ecology as a spiritual dimension are visions coexisting within the ecocentric philosophy.

The Language of Nature

How do these perspectives affect our perception of our surroundings? Literary texts which grant the environment its own first-person voice are a negligible minority. By contrast, we usually hear the voice of nature through third-party narrators. Throughout the history of English-language literature, numberless authors have been captivated by nature's beauty, entranced by its wisdom and enchanted by its power.

When referring to nature, literary discourse generally makes use of description or descriptive narratives with profuse use of adjectives. Personification is perhaps the most widely used figure of speech, assigning the environment quasi-human or animalistic qualities. In descriptions, nature has been depicted as a human kindred spirit or a sanctuary for the individual, an entity which is indivisible from man, or as a belligerent space between its own elements, with the individual, or with society.

By the late 20th century, ecological concerns gave birth to the ecological dystopia or perverse ecological utopia in many postmodern novels. In these works, conflict arises as a consequence of environmental problems: Descriptions are harsh and the worlds created are the setting, be it urban or natural, where human beings suffer the consequences of the actions of their forefathers.

Ecocriticism

The term ecocriticism was coined in 1978 by William Rueckert in his essay "Literature and Ecology: An Experiment in Ecocriticism" branching out from the cultural studies. It gained momentum in the 1970s and reemerged, as matter of course, in the 21st century. It is defined in general terms as the application of ecology and ecological concepts to the study of literature. As other movements within the cultural studies, ecocriticism aims to offer an ecological reading of literary texts to recuperate works overlooked in the past due to the lack of a consistent theoretical framework for their assessment. It also means to offer a theoretical corpus where new literary productions may be studied. The movement is a response to

modernity, which it deems deaf to the voice of the earth. It reflects the spirit of the time of liberationist movements which formed in the second half of the 20th century. According to Cheryll Glotfelty (1995) in her introduction to *The Ecocriticism Reader*, “ecocriticism is the study of the relationship between literature and the physical environment. Just as feminist criticism examines language and literature from a gender-conscious perspective, and Marxist criticism brings awareness of modes of production and economic class to its reading of texts, ecocriticism takes an earth-centered approach to literary studies” (p. xviii). This is a multidisciplinary movement by nature: As ecology itself, critics working today along these lines carry out research within the various areas that run through contemporary ecology and apply it to their literary readings. Ecocriticism ponders questions related to mimesis, the representation of nature, the role of the environment in plot development, the ecological (or antiecological) values of a literary work, the use of recurrent figures of speech or natural motifs and discourse characterization. Ecocriticism researches the cultural effects of green literary texts, be they canonical or not, on society, the interdisciplinary relationships these texts produce and the ideas that spring from these relationships in the Humanities.

Ecotranslation

One of the matters most discussed in translation studies has been the issue of the translator’s invisibility. According to Lawrence Venuti (1998), invisibility refers to two different interrelated phenomena: the discursive effect, or the use of language that the translator makes, and a reading practice, or the way in which translations are received and valued. In line with this issue of the translator’s invisibility as a political agenda to establish Anglophone discourses in foreign cultures outside the United States and effacing foreign marks in the Anglophone world, Gideon Toury and Itamar Even-Zohar’s polysystems theory (1978-1997) maintains that literary systems function and evolve under a variety of social restrictions. Considering that a translation as a product struggles to become part of the target culture’s repertoire, and that this new work will build new paradigms, or modify existing ones, at the heart of ecotranslation lies the idea that, if Western thought has traditionally produced grave consequences upon nature, should ecological ideas gain predominance, there should be a positive impact upon the environment. In order for translators to effect such systemic changes, ecotranslation puts forth the adoption of three different approaches: Rereading and retranslating literary works where nature, having its own voice in the source text, was silenced in translation; translating works that present an ecological cosmovision and have not yet been translated; and translating via manipulation works that do not originally present an ecological vision with the aim of creating a new, now ecological, text. To

illustrate how these stances are implemented in actual translation practice, we will provide three case studies.

Retranslation

The cultural studies have frequently made a point of rereading old texts in light of contemporary cosmovisions. In this sense, we propose selecting works to be retranslated in order to recuperate the lost voice of nature. New Zealand author Katherine Mansfield's work presents ample instances of natural accounts in her prose that pay homage to her native homeland. "At the Bay" (1912) offers a broad catalogue of adjectives for creating mood and atmosphere. The story opens with a description of dawn on the beach:

Very early morning. The sun was not yet risen and the whole of Crescent Bay was hidden under a white sea-mist. The big bush-covered hills at the back were smothered. You could not see where they ended and the paddocks and bungalows began. The sandy road was gone and the paddocks and the bungalows the other side of it; there was no white dunes covered with reddish grass beyond them; there was nothing to mark which was beach and where was the sea. A heavy dew had fallen. The grass was blue. Big drops hung on the bushes and just did not fall; the silvery, fluffy toi-toi was limp on its long stalks, and all the marigolds and the pinks in the bungalow gardens were bowed to the earth with wetness. Drenched were the cold fuchsias, round pearls of dew lay on the flat nasturtium leaves. It looked as though the sea had beaten up softly in the darkness, as though one immense wave had come rippling, rippling – how far? Perhaps if you had waked up in the middle of the night, you might have seen a big fish flicking in at the window and gone again. (Mansfield, 1983: 212)

Interestingly, this misty sunrise blurs the landscape and highlights the color palette. The humidity of the environment is reflected in lexical strings and semantic fields and the prevailing phonemic resource is the alliteration of liquid sounds which somehow mimic the movement of the sea.

Leonor Acevedo de Borges's translation also portrays a foggy, humid sunup, but different decisions in her translation take certain qualities away that may have otherwise been interesting to analyze from the point of view of ecocriticism:

De mañana, muy temprano. Aún no se había levantado el sol, y la bahía entera se escondía bajo una blanca niebla llegada del mar. Al fondo, las grandes colinas recubiertas de maleza, aparecían sumergidas. No se podía ver dónde acababan, dónde

empezaban las praderas y los *bungalows*. La carretera arenosa había desaparecido, con los *bungalows* y los pastos al otro lado; más allá, no se veían más que dunas blancas cubiertas de una hierba rojiza; nada indicaba qué era playa, ni dónde se encontraba el mar. Había caído un abundante rocío. La hierba era azul. Gruesas gotas colgaban de los matorrales, dispuestas a caer sin acabar de caer; el *toi-toi* plateado y flecudo pendía flojamente de sus largos tallos. La humedad inclinaba hasta la tierra todos los ranúnculos y claveles de los jardines. Estaban mojadas las frías fucsias. Redondas perlas de rocío descansaban en las hojas llanas de las capuchinas. Se hubiese dicho que el mar había venido a golpear dulcemente hasta allí, en las tinieblas, que una ola inmensa y única había venido a chapotear, a chapotear. . . ¿Hasta dónde? Quizás, al despertarse a mitad de la noche, se hubiera podido ver un pez gordo rozar bruscamente la ventana y huir. . . (Acevedo de Borges, 1982: 17)

In the English text, the narrator points out that this morning “the sandy road [. . .] the paddocks and the bungalows the other side of it” are no longer visible. The three elements in this catalogue share the human intromission in the natural context. In her translation, Acevedo de Borges opts for “La carretera arenosa había desaparecido, con los *bungalows* y los pastos al otro lado”. Her choices take the strength away from the ubiquitous presence of nature and the dwindling of artificial constructions. Spanish interference may have made Acevedo de Borges translate “paddock” first as “prado” (meadow) and then as “pastos” (grass) due to phonetic closeness between the source and the target languages, as opposed to “corral” or “potrero”. The point at hand here is that in the source text nature makes those man-made constructions vanish, while in the translation mixing artificial constructions and natural landforms subtract personality, entity and power to nature as Mansfield saw it. Similarly, the flowers mentioned, “ranúnculos y claveles” (buttercups and carnations), present both phonological and semantic problems. The former comes to engross the alliteration problems discussed below whereas the latter, in the Spanish-speaking world is a flower with a mortuary connotation, as it is typically presented on caskets and coffins. As pointed out, the original text offers different alliterations of liquid sounds which evoke the murmur of the sea. Acevedo de Borges, opts for the repetition of the /f/ sound, in “frías fucsias”, and the liquid /r/ sound, in “Redondas perlas de rocío”, which, when combined, evoke the sound of a steam engine, rather than that of the waves. Finally, the choice of the verb “chapotear” (splash) to describe the rippling of the waves also silences the voice of nature since in two of its three meanings in Spanish, the term

indicates sounds produced by moving feet or hands in the water: once more the human hand becomes an uncalled-for presence. In that respect, perhaps the verb “rizar”, which does not recognize a human agent, may transmit the same image as the source. Ecocriticism offers the ecotranslator the tools to better understand the source text in ecological terms and assess the ecological underlying values of its target text. What happens between these two moments depends to a large extent on the political stance of the translator.

Translation

Another strategy often adopted in contemporary cultural studies in unearthing texts overlooked in the past due to their seeming lack of canonical interest. In tune with this strategy, ecotranslation seeks undiscovered or lost works with ecological value to innovate the existing repertoire with new translated texts. Canadian author Charles G. D. Roberts was born in 1860 and grew up amidst the debate about Darwin’s theory of evolution which presented Nature as a senseless chaos. Roberts’ writings reflect a Darwinian vision of Nature: he wrote realistic animal fiction. The main characters are animals and the narrative is built from their point of view, not from that of the human observer who tells the story. Thus, animals have feelings of sadness, happiness or fear, and think, understand, and act accordingly.

“When Twilight Falls on the Stump Lots” (Roberts, 1902), published in Spanish as “Cuando en crepúsculo cae sobre los campos talados” (Badenes & Coisson, 2009) tells about the difficulties of a bear seeking food in the early spring. Hibernation has ended and upon awaking, the world around her is no longer the way she remembers it:

The winter had contributed but scanty snowfall to cover the bear in her sleep; and the March thaws, unseasonably early and ardent, had called her forth to activity weeks too soon. Then frosts had come with belated severity, sealing away the budding tubers, which are the bear’s chief dependence for spring diet; and worst of all, a long stretch of intervale meadow by the neighbouring river, which had once been rich in ground-nuts, had been ploughed up the previous spring and subjected to the producing of oats and corn. When she was feeling the pinch of meagre rations, and when the fat which a liberal autumn of blueberries had laid upon her ribs was getting as shrunken as the last snow in the thickets, she gave birth to two hairless and hungry little cubs. (Roberts, 1935: 276)

This third-person narrative identifies with the bear/protagonist of the story and narrates the mother’s anguish when she finds it difficult to provide

food for her offspring. Words suggesting the rigor of the environment such as “ardent”, “severity” and “meagre” are noticeable in the short story as, in true protoecological fashion, Roberts is careful to highlight that animal life changes when the human hand interferes with their environment.

Aware of the way in which actual translation decisions produce a determining effect upon readers and their relationship with nature, our 2009 translation sought to reflect the harshness of the surroundings and the animal despair.

Las nevadas escasas del invierno apenas habían contribuido a cobijar a la osa en su sueño; y los deshielos de marzo, inoportunamente tempranos y tórridos la llamaron a sus actividades demasiado pronto. Luego, las heladas llegaron con rigor tardío y congelaron los brotes de los tubérculos, que son el alimento principal en la dieta del oso durante la primavera. Además, un tramo largo de pradera junto al río cercano, que alguna vez había sido rico en nueces, había sido arado y sometido a la producción de avena y maíz la primavera anterior. Cuando sintió el peso de las raciones escasas y cuando la grasa que un otoño abundante en moras había acumulado sobre sus costillas comenzaba a desaparecer como la última nieve en los matorrales, dio a luz a dos cachorros pequeños, pelados y hambrientos. (Badenes & Coisson, 2009: 82-83).

At different points in the narrative, the personification of nature may be noted: It does not cover (“cobija”), but comes unseasonably (“inoportuna”) and with severity (“rigor”). In our translation, we preserved the idea of an animal diet instead of opting for a more general and impersonal term such as “food”. Similarly, the human hand forces (“somete”) the meadow to produce oats and corn in an instance of cruel intromission against the beings that feed on the natural bounty it offers. We found particularly important to preserve the image of giving birth (“dar a luz”) instead of bearing (“parir”) the cubs, even when in Spanish the former is restricted to humans. The choice of this text responds to the fact that Roberts’s prose transcends a mere description of the natural landscape and expresses the living relationships of natural elements represented as an autonomous world beyond human existence, and in many cases, instead of human existence.

In consonance with polysystems theory, we believe that translations occupy a peripheral position, as in the case of *Voces del norte*, but they may sometimes acquire a more influential role and gradually begin to perform a primary function in the system by making new forms and models become part of a repertoire.

Translation via manipulation

In the 21st century, there is a broader awareness of the translator's subjective presence in every translation. The politicization of translation is the sign of the times and the new yardstick to judge dominant culture. Just as a group of translators has not long ago appropriated the right to question source texts from a feminist perspective to intervene and carry out changes when the text they translate diverts from their political positions, ecotranslation proposes the manipulation of texts according to its own agenda. Considering the political impact of language, we propose the overt intervention of texts in translation.

In the tension between dominant and dominated cultures, between languages, and among the varieties and genres within the same language, it is assumed that power games are more easily represented in translation than in any other form of communication. As Theo Hermans (1986) indicates in *The Manipulation of Literature*, any translation implies some form of manipulation of the source text from the point of view of the target literature. This act may be intentional – but isn't any translation an intentional action? – or it may occur due to the different pressures exerted by linguistic, literary, and cultural codes. The search for dynamic equivalents presupposes a manipulation of the source text by putting into practice translation techniques which imply modifications with the aim of ensuring the accessibility of the translated version.

If we consider that in the polysystem, literary systems tend to flux from central to peripheral positions by interacting with other literary systems, we may conclude that ecotranslation may open up spaces for alternative cultures, literatures and ideologies which resist the hegemonic vision in which *man* is superior to nature. When an ecotranslated work enters the system, an ecological view may seep into dominant ideology and break existing social restrictions which may translate into new behaviors that leave behind antiecological practices. In this sense, ecotranslation contributes to the *production* and *reproduction* of an ecological ideology, seeing these terms in Van Dijk's view: "ideologies are (re)produced as well as (re)constructed by social practices. [...] "just as groups are reproduced (also) by getting or recruiting new members, also ideologies are reproduced by getting new 'users'" (1998: 228). This (re)produced ecological ideology will affect the form in which we conceive, relate to and write about the natural world.

Olive Senior is a Jamaican writer of humble origins born in 1941. In spite of the fact that she currently lives in Canada, her award-winning work always makes reference to rural and natural surroundings in Jamaica. Her stories revolve around a continuum of race, color and class, and nature is

presented as the backdrop in the struggles of her characters. Because of its ecological value, her work “Bright Thursdays” may be worth ecotranslating:

The houses were perched precariously up the hillsides with slippery paths leading to them from the road, and if anyone bothered to climb to the top of the hills, all they would see was more mountains. Because it was so hilly, the area seemed constantly to be in a dark blue haze, broken only by the occasional hibiscus or croton and the streams of brightly coloured birds dashing through the foliage. They were hemmed in by the mountains on all sides and Laura liked it, because all her life was spent in space that was enclosed and finite, protecting her from what dangers she did not even know. (Senior, 1986: 45)

Even though there is an organic image that evokes in the reader the idea of veins and arteries, these respond to the human hand embodied in roads and paths. A human narrator describes the scene underlining the ubiquity of the steep landscape she inhabits which is only interrupted by intrusions of natural beauty. Hints of nature as a sanctuary are worth noting as it protects the protagonists from external hazards.

Las covachas estaban construidas con descaro en las laderas de las colinas. Desde el camino se dirigía hacia ellas una maraña de senderos resbaladizos, y si algún humano se molestaba en trepar a la cima de las sierras, lo único que podía ver eran más montañas. Las profusas pendientes hacían que la silueta del área se vistiera de una bruma azur vehemente que solo se atrevían a interrumpir aquí y allí el ardiente anaranjado de las cayenas o el intenso esmeralda de los crotones y el torrente de pájaros tornasolados que trajinaban con afán por el follaje. Para donde se mirara, los abrazaban montañas, y a Laura le daba gusto porque había pasado toda su vida en un espacio limitado y contenido que la protegía de peligros que ni siquiera podía imaginar. (Badenes & Coisson, unpublished)

In this version, we have manipulated the text in different instances in order to draw attention to the idea of nature as a maternal nurturer, as a being whose existence is independent from humans, as a precious gem, and as a hardworking system in harmony with itself. Meanwhile, we have underlined the daring insolence of human intrusion in this environment. In our version, the “houses perched precariously” are but shanties built shamelessly by man. We have stressed the idea that artificial constructions such as the roads and the houses provide chaos and conflict. Additionally, the vague “anyone” becomes in our translation “any human being” (“algún humano”) and,

incorporating semantic fields and lexical strings, we have been able to transmit the notion that humans bother (“molestar”) and that the natural environment is a jewel (“azur,” “esmeralda”). In turn, color has been added to several nouns so as to create visual images which may enhance the beauty of nature. Finally, nature has been personified throughout the excerpt with verbs such as embrace (“abrazar”), move (“trajinar”), and the like.

The motivations behind this work lie on the belief that through translated literature we can raise ecological awareness and produce changes in society. The translator appropriates the source text in order to rewrite it as a legitimate tool according to the translator’s political agenda.

Conclusion

Final comments, or new beginnings

Cultural studies have provided the academia with the understanding that throughout the history of literature there have been innumerable voices which were silenced simply because they lacked entity within the establishment. Just as for centuries we have taken the existence of Nature for granted, disregarding the care that we owe to it, we have interpreted translation as an existing reality which is nothing but a means to an end.

Much has been written about our environment in Anglophone literature, and perhaps there may be those who expect a natural response on the part of our surroundings before they start to take action, but this is not the aim of ecocriticism. It is up to ecocriticism to elucidate the vision that human beings have of nature. When we certainly understand our position, we may take stands to better represent the environment.

We have pointed out that in the past, different translation practices, either mistakenly or purposefully, misunderstood the voice of nature. These once invisible translators can become political subjects today in a world that expects us to state our intentions, take responsibility, and assume a political position in our work.

Meanings are built, but also rebuilt, and just as we reforest barren ground, through translation we may also construct or restore ecological thought. We know the visions of nature are numberless as we have tried to reflect on these pages, but we are convinced that ecotranslation may make amends to many woes that centuries of history have caused to Western thought. Recuperating the voice of nature is the road less travelled that we may begin to walk together.

References:

“Genesis.” *The New Oxford Annotated Bible with the Apocryphal/Deuterocanonical Books: New Revised Standard Version*. New York: Oxford UP, 1989. 2-68. Print.

- GLOTFELTY, C. (1996). "Introduction: Literary Studies in an Age of Environmental Crisis." *The Ecocriticism Reader. Landmarks in Literary Ecology*. Cheryll Glotfelty & Harold Fromm eds. Athens: University of Georgia Press.
- HERMANS, T. (ed.). (1985). *The Manipulation of Literature: Studies in Literary Translation*. London: Croom Helm.
- MANSFIELD, K. (1912). "At the Bay." *Short Stories*. London: Everyman, 1983.
- . "En la bahía." *En la bahía*. Leonor Acevedo de Borges, trad. Barcelona: Bruguera, 1982.
- NAESS, A. (1995). "The Shallow and the Deep, Long-Range Ecology Movement: A Summary." *The Deep Ecology Movement: An Introductory Anthology*. Berkeley, California: North Atlantic Books.
- ROBERTS, C. (2009). "Cuando el crepúsculo cae sobre los campos talados". *Voces del norte. Cuentos canadienses hasta la Segunda Guerra Mundial*. Guillermo Badenes y Josefina Coisson trad. Córdoba: Ícaro.
- . "When Twilight Falls on the Stump Lots." *The Kindred of the Wild*. Boston: Colonial Press, 1902.
- RUEKERT, W. (1996). "Literature and Ecology: An Experiment in Ecocriticism." *The Ecocriticism Reader. Landmarks in Literary Ecology*. Cheryll Glotfelty & Harold Fromm (eds.) Athens: University of Georgia Press.
- SENIOR, O. (1986). "Bright Thursdays." *Summer Lighting and Other Stories*. Essex: Longman.
- Even-Zohar, I. and Toury, G. (1981). "Introduction." In *Translation Theory and Intercultural Relations*. Even-Zohar, Itamar and Toury, Gideon (eds.) [A special issue of Poetics Today], vol. II, N°4: 1981. v-xi.
- VAN DIJK, T. (1998) *Ideology. A Multidisciplinary Approach*. California, Sage Publications Inc.
- VENUTI, L. (1998). "American Tradition". *Routledge Encyclopedia of Translation Studies*. M. Baker and K. Malmkjaer (eds) London and New York: Routledge.

NETWORKS ROLE IN CONTEMPORARY SOCIAL MOVEMENTS AN EMPIRICAL ANALYSIS OF THE ANTI- NUCLEAR MOVEMENT OF JAPAN

Rosemary Soliman, PhD course

Waseda University, Graduate School of International Culture and
Communication studies. Tokyo, Japan

Abstract

Some scholars tend to limit the role of networks as an instrument that gathers participants in one place to achieve a mutual goal. There is no doubt that networks are mobilized as an instrument in the process of individual participation of a social movement. For example, interpersonal relations and social ties can be categorized as an instrumental network. Instrumental networks played a marginalized role in most of both old and contemporary social movements; the Velvet revolutions in Eastern Europe in 1980s, Japanese student's strikes in 1970s, and recently the Arab revolutions in 2011. However, interpersonal relations and social ties are not always mobilized for positive purposes like those mentioned above, but they can also be mobilized for negative and radical purposes like what we are witnessing in the Islamic State, Al Qaeda, and other terroristic groups. Many theorists have emphasized on the role of the Interpersonal or instrumental networks in individual participation, and this role is not only found in contemporary social movements, but also in other historical contexts (Shiohara 1988; Oberschall 1973; Kriesi 1993; McAdam 1982). The aim of this paper is not to reemphasize on the role of interpersonal networks; rather it is to address other functions that networks have in contemporary social movements that exceeds the role of being just an instrument. By analyzing the Japanese antinuclear movement that took place in Japan after the great Tohoku Earthquake in 2011, I will try to prove my hypothesis that networks have multiple functions and play a great role in collective actions.

Keywords: Networks, Anti-nuclear, social movements, Rhizome, Japan

Introduction

Before going through my empirical analysis of the anti-nuclear movement in Japan I want to address a very important and stimulating question that was asked to me by one of my Japanese professors during our discussions. Why is it important to emphasize on networks' other functions? Other scholars, like McAdam and Paulsen (1993) have already discussed the answer to this question. I would like to address the theoretical reasons that I found out after conducting my empirical analysis on the Japanese anti-nuclear movements over the last three years (2012-2015).

One of the complexities of recent collective actions is that there are several groups with multiple goals in one movement. Of course some of them can be analyzed through the framework of instrumental network since they are relatives, work colleagues or even activists. On the other hand, there are housewives, businessmen, retired people, and under 18 year old students who have never had any experience in political activities before. Grasping the dimensions and other functions of the networks will provide us with better knowledge to know the development of the mechanisms of social movements and how participants get involved in the contemporary collective actions.

As White (1992:67) cites: "*a social network is a network of meanings*", and by analyzing the functions of networks, this will provide us with more information about the process of constraining participation and collective identities in social movements. In turn this will lead us to the learning more about the mechanisms and dynamics of the contemporary social movements and the process of creating collective identities.

I.

The Organizational Network

When participants engage in any social movement, they share mutual norms and values related to a specific area of political contention (Fernandez and McAdam 1989). However, getting involved in the collective action doesn't probably mean that every one is qualified to be a leader and take a part in the decision-making process. This is the mechanism that "Hangenren" uses in the anti-nuclear movement of Japan. Hangenren or "The Metropolitan Coalition Against Nukes" is the biggest group of the antinuclear movement in Japan. They were the first group who called for a movement against the Noda administration in September 2011. They have sponsored so many events and lectures to raise people awareness regarding nuclear energy dangers, and have provided reasons behind joining the movement. In January 2012, they held a movement in Yokohama called Rally for a Nuke-Free world in Japan. More than 4500 people joined and turned it into a large-scale movement. On the memorial day of the great

earthquake in March 2012, they held a march for the victims who were lost, calling it “Towards a New Beginning”. In 2013, they held a candle light vigil against nukes, and it was attended by one million and four thousand participants according to the group website³⁰. This large group is consisted of 11 groups: the Act 311 Japan, the Orchestra for a Safe Future for our Children, the Anger Drums, the Energy Shift Parade, the Countries Demonstration, the No Nukes Sugunami, the Tanpopo, the Twit No Nukes, the No Nukes More Hearts, the Let the Vegetables Say a Word! Goodbye Nukes Demonstration and the Loft Project. These 11 groups that take a part in Hangenren and join the weekly demonstrations in front of the Prime Minister’s residence.

We can conclude that the main reason of this network is to raise people awareness regarding the nuclear energy dangers through a quote by Misao redwolf (48), the main leader and the spokeswoman of Hangenren. She said: *“Although we are the only country in the world that experienced the atomic bomb, most Japanese people still believe that nuclear energy has no dangers. That's why there was a necessity to bridge this gap by creating a link between us ‘Hangenren’ and the participants to raise their awareness and stop them from believing the government myths of nuclear safety”*. However, the question here is why does it have to be “organizational”? In Hangenren terms, “organizational” is quite similar to a pyramid or a top-down relation. There is a certain leader who is responsible of the planning of the movement and setting of the goals and agendas of the group. The other participants are not allowed to join in this process due to their lack of experience and qualifications to be involved in the decision-making process. During my interview with Redwolf she said *“Every one is welcomed, regardless of their political or educational backgrounds, but on our conditions”*. Since the movement that Hangenren controls is a single issued one, so every one who chooses to join this network is supposed to call for “anti-nuclear”, and anything else that has no direct relation to the main issue is disapproved. During the movement there were some groups who called for gender equality, unemployment awareness, and other demands that are not directly related to “anti-nuclear”. Those who called for such demands were dismissed from the movement because they shared something that did not match with Hangenren’s agenda.

“Everyone is welcomed, but on our conditions” is the core of the organizational network which is represented by Hangenren in Japan. The collective identity in this group is created according to the agenda of

³⁰ Hangenren official Japanese website: <http://coalitionagainstnukes.jp> there are some English links but they have less information comparing to the Japanese version. The English website is : <http://coalitionagainstnukes.jp/en/>

Hangenren that was set formerly by Redwolf and not by the will of the participants. The participants of this network are identified as “antinuclear members” but not as a “decision makers”. There is a leader, who is responsible for the process of decision-making, but there is no debate nor is discussion allowed to change the strategy of the network unless it is from the designated “leader”. The organizational network functions as a bridge between leaders and participants in a top-down relationship. In this perspective, participating in the organizational network requires sharing the same ideological values to be identified as a “Hangenren member”.

The Digitalized Network

Rationalist scholars and critical mass theorists tend to stigmatize the digitalized network or SNS as a communication tool that gathers participants by providing them with information related to the action date, time and place (Morozov 2011). Rationalist scholars like Emirbayer and Goodwin (1994) are addressing the same debate in their paper on social networks, defining networks in instrumental terms. They are assuming that social interactions in any collective action are the main roles of the networks in social movements. In this regard, rationalist scholars are conceptualizing networks as an instrument for something more important which is the collective behavior. Passy (2002) is raising an interesting comparison between rationalists and structuralists interpretation of the functions of networks in social movements. He is arguing that the former conceive social influences in overly narrow terms unlike the structuralists who tend to emphasize on the role of networks in creating participants identities and how it functions in the formation of a potential for participation and recruitment in social movements.

Through analyzing the role of digitalized network in antinuclear movements, I will be able to address two more functions of the digitalized network that were not discussed by rationalist scholars; the role the digitalized network plays in enlarging the scale of the movement and how it can provide a space for individual participation, and how digitalized networks functions as an alternative media and a new space for free deliberation.

Enlarging the scale of the movement

Digital social networks offer the possibility for a free deliberation. On the Internet people can create free communities that are not controlled by any authoritarian regimes or occupied by the interests of the dominant elites and their networks. The digitalized network does not have boundaries or barriers, rather it is de-centered and expanding frontiers where power can be efficiently distributed in it. Everyone is identified as an “Internet user” no matter what his nationality, political affiliation, or educational background is.

Moreover every Internet user can join this deliberative space freely turning it into a democratized community for raising other political standpoints with no conditions. Castells (2012) argues that digitalized networks are based on the term of “togetherness”. According to Castells, “togetherness” is a fundamental psychological term to overcome fear. And overcoming fear is the fundamental threshold for individuals to engage in social movements. The Arab uprisings are a significant example of practicing the term “togetherness” through the digitalized social network, turning the Internet into a democratized political realm to gather people from diverse political and social backgrounds together. This “togetherness” is what ultimately led to the fall of Mubarak Regime. Japan is not an exception to this concept. Although Japan has more rights to freedom of speech comparing to that of Egypt, the Internet has played a great role in enlarging the scale of the anti-nuclear movement. One of the admins who is followed by more than five thousand users on twitter said to me once that without twitter he would have never thought to join the movement in real because he thought he might be the only person who is not satisfied regarding the Noda and Abe administrations. However, after he started tweeting about the anti-nuclear movement he received thousands of positive feedbacks asking him to join the demonstration and say that in real³¹. The retired computer programmer Yukio Kurosu (68), whom I met during the demonstration was posting everything directly to his Facebook page saying that he was receiving messages from people whom he didn't know, personally asking him about the details of the movement and where they could join.

Through digitalized social network people can share the same interests and goals that can motivate them to join the real movement in the urban space to mobilize the values and contentions they shared on the Internet realm. Digital networks function as a motivating and identifying sphere where people can gather their courage together carving out their own community in the urban space for social change.

Digitalized Networks as an alternative media

Digitalized networks were necessary in a country like Egypt where there was no real free space for deliberation under the Mubarak authoritarian regime. Therefore, there was a necessity to create a free discursive space that was not controlled by any public institution. However, this is not the case in the anti-nuclear movement of Japan. There is an enough deliberative space for individuals to raise their voices against the government policies with no fear of police brutality unlike the situation in most of the Arab countries. The question here is if Japan has such a free discursive urban space why the

³¹ The official account on twitter is : https://twitter.com/demo_jhks

digitalized network is needed? As I have mentioned before, the digitalized networks are mobilized in Japan as a space for deliberation and individual participation to enlarge the scale of the movements. On the Internet space, there are unfamiliar demonstrations like “hitori-demo” or the “one person demonstration” which is held by Tachikawa Shinya (50) a farmer in Kyushu; Japan’s third largest island. Shinya is using the Internet as space to share his ideologies because he is not able to join the weekly demonstration in Tokyo. However, those are not the only roles that digitalized networks play in the movement.

Japan mainstream media, like in so many countries, is either controlled by the government or have pro-nuclear agendas. That's why they rarely talk about the “anti-nuclear” movement in the news or any other talk shows. Mainstream media and public institutions cannot be against the operation of the nuclear reactors , since most of the advertising campaigns for the Toden reactors are mainly broadcasted through their channels. Now, here is where the role of the digitalized network as an alternative source of information and citizen journalism comes into action. Citizen journalists are collecting, analyzing and disseminating news that is not broadcasted in the mainstream media institutions as a response to shortcomings in the coverage of the movement. Aozora Houso³² website is an example of citizen journalism in Japan. The admin of the website is Yoshinori Fukuda (61) a painter and kimono designer, however, his website is alive channel that transmits all the speeches and the progress of the anti-nuclear movement online. *“Mainstream media cannot be a trustworthy information source, since they gain economic benefits from the advertising campaigns of the Toden Nuclear Reactor. That's why there is a great need to show those who are still believing in government myths and mainstream media the truth. I feel disappointed when I see reporters from Germany, France, Italy and china who came specifically to deliver the demonstration news to their countries, while the Japanese TV doesn't mention a single word about the movement!”* said Fukuda criticizing the policies of main stream media and emphasizing on the role his website plays in spreading the movements progress and the situation of Fukushima.

Fukuda is a citizen journalist who was driven by anger and dissatisfaction towards mainstream media and he decided to move to Fukushima to report the truth that is never mentioned. Digitalized networks have played a great role in introducing a new source of legitimate and objective media that is not controlled by certain political party or any public

³² Aozora Houso is a channel on Ustream that used to broadcast all the news that is related to the anti-nuclear movement until September 2014. The official website: <http://www.ustream.tv/channel/あおぞら放送>

institutions. Yukio Kurosu (68) is a retired computer programmer who never missed a week of the demonstration, always having his camera to take photos and videos to post them on his blog and Facebook page. *“Since we are joining this demonstration we have a duty! Our duty is not about participating in the weekly demonstrations and when it finishes we just go home and wait for the following week, we must share what we are witnessing every week. We must record those moments for our grandsons to know to what extent did their parents and grandparents fought for Japan! I am posting all the videos and pictures I take on a weekly basis on my Facebook page and my blog. I am not forcing anybody to come and join the demonstration, but I share with those who are not able to come the real situation that won’t be ever broadcasted on mainstream media”* Yukio said when commenting on the importance of digitalized social network and how he is strategically using it. Yukio used to take a part in the Anpo Struggle during the 1970s, protesting against Kishi’s unorthodox parliamentary maneuvers to pass the Anpo Bill, despite society’s conspicuous dissatisfaction.

Since Japan mainstream media and local newspapers like Yomiuri shimbun are obviously promoting the pro-nuclear agenda, it can influence wide range of its fans and readers to support pro-nuclear strategy. If there was not another strong side to criticize their agenda and prove the opposite and the hidden agendas behind their strategy of mind controlling the readers, nothing will change.

The Rhizomatic Network

Rhizome is a philosophical term that stems from the theories of Gilles Deleuze and Felix Guattari. The word is derived from a Greek word meaning “to take a root”. Rhizome is represented as a tree model which can be interpreted as a symbol of hierarchy. However it can also refer to binary systems, because every new branch ties back in some essential way to the root that makes all growth possible.

One of the ways in which networks play in the Japanese anti-nuclear movement is unification of all the diversified groups with their multiple goals and agendas into one cohesive network. This is the reason why Fisher (2003) is calling the Rhizomatic Network, “the network of networks”. In this section I am going to hypothesize more functions of the Rhizomatic network and its role in integrating most of the participating groups with their diverse agendas and goals in horizontal, non-hierarchical, acentered and heterogenous way in the Japanese antinuclear movement of Japan.

As I have argued, both organizational and digital networks play a marginalized role in the movement that exceeds the role of being instrumental. Whilst the organizational network that is represented in

Hangenren helps in raising the participants awareness through some educational lectures and sessions to explain the movement demands, the digitalized network functions as an alternative source of media to broadcast all the news that is not shown in mainstream media institutions. Besides it provides a space for free deliberation where individuals, regardless of their political and educational backgrounds, can interact and get to know the necessity of joining the movement and thus they move their deliberative space from the cyberspace to the urban space. The Rhizomatic network is wider than the former two networks. Since it is non-hierarchical it can connect between all the groups without having a certain leader like in the organizational network. Moreover, it doesn't aim for certain categorical organization like the digital network does when it connects internet users, but rather it gathers all the groups with their multiple identities, which makes the Rhizomatic Network unique. As we are going to see in the next analysis of some groups who have joined the movement, I will be able to illustrate the role of Rhizomatic network in the antinuclear movement and why the movement managed to last for four years without getting disseminated by the government or the police.

Although the main goal of the movement is to stop the nuclear reactors, the movement also acted as a space for raising other social and political demands in Japan. "Mama demo" is a significant example of these groups. "Mama Demo" was firstly created by single mothers who joined the movement in 2011. *"Most of us have never joined any political activity, antinuclear movement is the first movement that we have ever joined"* said Chieko Uomizu (50) one of the active leaders of "Mama demo". She continues: *"we realized that we, women, are deprived of our rights. We are neglected and we are dismissed from work when we get pregnant. I just want to know what is so wrong with being a mom?"*

"Mama Demo" like any other group firstly joined the movement because they were against re-operating the nuclear reactors. But gradually they started to realize that they have other demands that can not be represented through the anti-nuclear movement or Hangenren channels. Therefore, they decided to make their own group to call for gender equality and single mother rights.

The anti-nuclear movement is divided into several spaces, one of them is the space of "family area", where mothers were allowed to bring their children to join the demonstration with them. The family area was the turning point that made the members of "Mama Demo" realize that they have other demands that the antinuclear movement was not aware of. Consequently, they created their first group for gender equality and women rights naming it "Mama Demo" as most of the members of the group were the mothers who came with their children to the family area. Each group that

is participating in the movement had one major goal, which was to stop the nuclear reactors. However, by getting involved in the movement, it contributed in raising their awareness to other issues and demands that these groups feel they have been deprived of in Japanese society. “Mama Demo”, being one such group and their pursuance in gender equality. Although “Mama Demo’s” agenda is totally different than that of Hangeren, Kumagai (28) an unmarried stylist and a member of “Mama Demo” comments: “ *we are not more isolated than hangenren or any other groups, you know that we don't have either high political consciousness or an experience in planning movements and peaceful marches, that's why we are communicating with other groups and inviting them to most of the events we are organizing to help us with their advice*”. According to Kumagai, not all the groups that are participating in the antinuclear movement are single issue ones. However, having different agendas doesn't mean the groups are isolated from each other, but rather this opens up a chance for communication among them, to share knowledge and experiences to progress all movements. It is extremely rare to see clashes between anti-nuclear groups or even between the groups participants and the police , which was enlightening for me, because, as an Egyptian, I could never imagine a situation where joining a social movement would not result in clashes between security police and demonstration participants.

One of the most interesting incidents that I have witnessed several times during the movement, was a police officer is shouting at one of the participants and the latter was yelling in anger “you don't have any right to tell me what to do !” “it is not your business!”. At first glance I thought it was going to be the same scenario during Jasmine Revolution in Egypt. However, what happened next was different than what I had been witnessing in any other movement before and that was one of the most important roles Rhizomatic networks play in anti-nuclear movement. Another gentleman had suddenly showed up, and he started talking with the participant “Ochi-tsuite! Ochi-tsuite!” which means “Calm down! Calm down!” Then he asked him to go back to the demonstration lines while he continued talking with the officer. The whole situation lasted for less than 10 minutes, a confrontation was averted, and things went back to normal. I have seen this process frequently in front of the Prime Minister’s residence, and so I decided to follow this gentleman to know more about his role in the movement.

Ichigaya Kinoshita (44) is a political scholar and activist. He has participated in so many social movements, starting from the “Anti-war in Iraq” protests, to today’s anti-nuclear movement. When I asked Kinoshita about his role in the movement, he said that he is a member of a group called “keisatsu Tai”. “*The group aims to keep the movement peaceful with no clashes among participating groups or between the groups and the police*

officers. We don't have any political affiliation and we are not members of any of the participating groups. Our agenda is just to secure the movements, and keep the relations between the participants and the police positive in order to keep the movement continuing until it achieve its goals” Kinoshita said to me when I asked him about his role in the movement. The anti-nuclear movement became a space for free deliberation for everyone starting from young adults just gaining experience and knowledge to the elderly, who have had rich experiences of joining the largest social movements and strikes in postwar Japan participating in the Anpo struggle and the Voiceless Voices movements to act out a model of civic participation in a democratic society.

Conclusion

Networks have more functions than just as an instrument that gathers individuals. In the anti-nuclear movements of Japan, networks at least function in three ways that rationalist scholars have undermined it in their researches. First, the organizational network which functions as a bridge that creates a mutual identity, such as the “Hangenren member”, enables each participant to be a member of the network regardless of their diverse political consciousness and educational backgrounds. Although the Organizational Network is a top-down structured network, it has a significant role in raising the awareness of the participants through the educational sessions and lectures that are given to the participants so that they are better able to understand the movement’s demands and progress. Second, are the Digitalized Social Networks, which allow users to have a deliberative and discursive space to create a strong community that eventually moves to an urban space to enlarge the scale of the movement. In addition, Digitalized Networks act as an alternative media that provide people with all the information regarding the nuclear power, the movement’s progress and other incidents that are never reported in mainstream media and local newspapers. Last is the Rhizomatic network, which doesn't aim to lead people or intervene in the process of the individual participation, but to preserve the continuity of the movement for the longest period without troubles or clashes with other groups or with police officers.

If the Organizational Network and Digitalized Social Networks are the reasons for enlarging the scale of the movement, the Rhizomatic network or the “network of networks” is the main reason behind the movement’s continuation regardless of the government oppression. Therefore, the Networks role is not only limited to instrumental perspective, but they also play a marginalized role in facilitating recruitment to social movements. Networks are important because it provides us with better knowledge of the dynamics and mechanisms that induce people to join the movement. They are not just instruments but they should also be analyzed as independent

norms that provide participants with a collective identity and a free deliberative space where they can have interactions with others to change the society through real deliberation and creativity.

References:

- Abishk, Singh and Gopal Thakur. (2013). New media technology as public sphere for social changes: A critical study. *Journal of Indian research*, Vol.1, No.2, 38-43.
- Blumer, Herbert. (1969). *Collective Behavior*. Alfred McClung Lee ed., Principles of Sociology, New York: Barnes & Noble.
- Castells, Manuel. (2012). *Networks of Outrage and Hope: Social Movements in the Internet Age*. Polity press.
- Dahlberg, L. (2007). The Internet, deliberative democracy, and power: Radicalizing the public sphere. *International Journal of Media and Cultural Politics*, Volume 3, Number 1, pp. 47–64.
- Deleuze, G., and F. Guattari. (2008a). Introduction: Rhizome. In *A Thousand Plateaus*. London: Continuum, 3-28.
- Deleuze, G., and F. Guattari. (2008b). 1730: Becoming-Intense, Becoming-Animal, Becoming-Imperceptible. In *A Thousand Plateaus*. London: Continuum, 256-341.
- Emirbayer, Mustafa, and Jeff Goodwin. (1994). Network Analysis, Culture, and the Problem of Agency. *American Journal of Sociology* 99: 1411-54.
- Fisher, William, and Thomas Ponniah. (2003). *Another World Is Possible*. Verso.
- Habermas, J. (1989). *The Structural Transformation of the Public Sphere: An inquiry into a category of Bourgeois Society*, T. Burger and F. Lawrence (trans.), Cambridge, MA: MIT Press.
- Johnston, Hank and Bert Klandermans. (1995). *Social movements and culture*. University Of Minnesota Press.
- Kim, Hyojoung, and Peter S. Bearman. (1997). The Structure and Dynamics of Movement Participation, *American Sociological Review*, 62: 70-93.
- Kriesi, Hanspeter, Ruud Koopmans, Jan Willem Duyvendak and Marco Giugni. (1995). *New Social Movements in Western Europe*. Minneapolis: University of Minnesota Press.
- Mayer N. Zald, and John D. McCarthy ed. (1987). *Social Movements in an Organizational Society: Collected Essays*, New Brunswick: Transaction Publishers, 15-42.
- McCarthy, John D., and Mayer N. Zald. (1977). Resource Mobilization and Social Movements: A Partial Theory, *American Journal of Sociology*, 82(6): 1212-41.

- McAdam, Doug, and Ronelle Paulsen. (1993). Specifying the Relationship between Social Ties and Activism. *American Journal of Sociology*, 99: 640-67.
- McAdam, Dough, and Mario Diani. (2003). *Social movements and networks: relational approaches to collective action*. Oxford: Oxford university press.
- McAdam, Dough, and Roberto Fernandez. (1989). Multiorganizational Fields and Recruitment to Social Movements. *International Social Movement Research 2*: 315-43.
- Melucci, Alberto. (1996). *The Playing Self: Person and Meaning in the Planetary Society*. Cambridge: Cambridge University Press.
- Morozov, E. (2012). *The net delusion: the dark side of Internet freedom*. Public affairs.
- Oberschall, A. (1973). *Social conflicts and social movements*. Englewood cliffs, NJ:Prentice-Hall.371pp.
- Passy, Florence. (2002). *Social networks matter. But How?*. Oxford: Oxford university press.
- Sen Fulya A. (2011). The Rise of Public Opinion and Social Media, *International Conference On Communication Media And Technologies, Eastern Mediterranean University* ,Vol.1, ICCMTD,490-492.
- Tilly, Charles. (1995). To Explain Political Processes. *American Journal of Sociology*, 100 : 1594-1610.
- van Dijk, Jan (2000). Models of Democracy and Concepts of Communication. In K. Hacker and J. van Dijk (Eds.), *Digital Democracy. Issues of Theory and Practice*. London,Thousand Oaks CA, New Delhi: Sage.
- van Dijk, Jan (2006). *The Network Society, Social Aspects of New Media*. London, Thousand Oaks, New Delhi: Sage.
- White, Harrison C. (1992). *Identity and Control*. Princeton: Princeton University Press.

AN INDONESIAN PERSPECTIVE TOWARD MARITIME VISION: IS PURSUING NATIONAL INTEREST WHILE MAINTAINING NEUTRALITY IN THE SOUTH CHINA SEA POSSIBLE?

Masyithoh-Annisa Ramadhani, S.IP
The University of Birmingham, United Kingdom

Abstract

Overlapping claims in the South China Sea has turned into a contested zone for global powers to project their roles in the region. Given the political uncertainty in international affairs, states prefer to acquire their own national interests for the sake of nations' prosperity. Indonesia, one of regions' prominent actors committed to be a non-claimant state in the dispute, is trying to invigorate cooperation through its maritime vision notably known as "Global Maritime Nexus" despite region's security dilemma. It aims to enhance mutual opportunities for all actors involved at the dispute thereby diminishing any possibility of the worsening power competition. Association of the Southeast Asian Nations (ASEAN) as one of regions' most prominent multilateral organizations is expected to be a cornerstone for a more peaceful dispute settlement so it could move forward on fostering members' prosperity and security. However, Indonesia is a sovereign state which must hold their national interests at stake when it comes to any international affairs. It is therefore becoming a challenge for Indonesia on pursuing national interests while maintaining its neutral position as non-claimant state at the same time.

Keywords: South China Sea, maritime, Indonesia

Introduction

The recent massive land-reclamation activity done by China on the Spratly Islands in the South China Sea has alarmed many countries engaged in Asia Pacific region. However, China insisted that maritime reclamation has been part of their life since other countries like Japan has been fortifying the Okinotiri Islands and demanded an exclusive economic zone but the United States has been silent on this matter (Huaxia, 2015). "Nine-dashed line" claimed by China which embraces some 80% of the South China Sea

is described as China's historic waters. This claim has raised an awareness of its neighbour as they believe that they are also entitled to advance natural resources and other potential at the region. Sovereignty claims and energy vulnerability become the two major factors which exacerbate the dispute. As a sea which holds huge amount of potential energy resources, thus it potentially becomes one of the most protracted conflict zones in Asia Pacific where both regional and international players try to assert their unequivocal primacy over the disputed area. There are at least six countries with their interests at stake at the competing territorial and jurisdictional claims in the South China Sea; China, Taiwan, Vietnam, Malaysia, Brunei, and the Philippines. Among all claimants, China persistently plays the most of aggressive behaviour proven by the military build-up and public statement by Chinese officials in regard to their reluctance to external parties' engagement, the United States (U.S.) for instance, in the dispute. On the other hand, U.S. argued that they have underwritten regional security for decades patrolling Asia's sea lanes and preserving stability therefore their presence in playing a more contributive roles in the region is needed (Clinton, 2011). Notwithstanding the fact that U.S. was never truly absent from Southeast Asia, the ongoing commitment to its regional allies, and overwhelming maritime military presence – the perception that U.S. role in regional affairs was declining since China was ascending cannot be easily dismissed (Anwar, 2013).

At the height of global power projections, Republic of Indonesia as one of ASEAN's founding fathers who has been actively promoting the principle of non-alignment or notably known as its "non-block" approach in international affairs, has tried to become pioneer in mitigating the potential risks surrounding the region such as initiating the discussions on the formulation of Declaration of Conduct (DOC). However, as a sovereign state, Republic of Indonesia must also have its national interests at stake despite its commitment to contribute on peace and security formation on both regional and international affairs. On October 2014, Indonesia's newly elected President Joko Widodo has announced a new top priority in terms of foreign policy concern emphasizing on the importance of maritime power through officially announced vision of "Global Maritime Nexus" (GMN). Through this vision, Indonesia is expected to play a more contributive role in the formation of regional security and economic. Pursuing national interests while maintaining its neutral position as non-claimant state would be a potential challenge for Indonesia.

This article is structured as follows. Firstly it will explain the global power projections in the South China Sea involving U.S. and China. Second, it will try to portray Indonesia's interests in the region despite its status as non-claimant state, noting a number of economy and security at

stakes. It will finally explain the significance of maritime vision invigorated by Indonesia towards the maritime boundary dispute in the South China Sea. My argument on whether or not Indonesia through its maritime vision could maintain neutrality despite global power projection in the South China Sea goes to three significant points. First, Indonesia will strive to maintain good relations with all claimant and non-claimant states involved at the South China Sea dispute in order to pursue national interests at stake. Second, maritime vision could become a strategy to enhance unity among members on Indonesia's closest priority at regional basis, ASEAN, in order to enhance benefits for ASEAN members. Third, this could further reduce the height of great power projection in the South China Sea due to the establishment of potential shared opportunity through cooperations.

I.

The South China Sea dispute which covers the Pratas Islands in northeast, the Paracels in north, the Spratlys in south, and Scarborough Shoal in central east has abundant natural resources and trade potential thereby it is critical for countries surrounding to think about benefit from this area as the means of pursuing national interests. In the unpredictably world constellation where no state can rely on other's assurance in maintaining security, maximizing defence strategy might be best applied by state in ensuring their interests. Thus, China's effort in doing reclamation for any purpose may be taken into account as the logic effort to maintain interests at stake. However, problem has started to rise up when there has been no agreed consensus among all claimants. The United Nations Convention on the Law of the Sea (UNCLOS) as the generally accepted customary international law is considered as the only credible framework within which any kind of exclusive claims can be made despite the fact that the United States have failed to ratify it (Evans, 2015). China seemingly prefers bilateral layer discussions in mitigating the dispute instead of through multilateral layer such as by ASEAN. It can potentially lead to the imbalance power in negotiation since China's growth militarily and economically may be such a worrisome to others smaller states. Given the fact that two region's most prominent multilateral bodies members', Association of Southeast Asia Nations (ASEAN), involve into the dispute as claimants; Vietnam and the Philippines, therefore it raises a big concern for ASEAN to take an initiative step through peaceful arbitration. However, delimitation of maritime boundaries plus the hitherto obscure over the land remains present since there is no agreed law-abiding regulation among all claimants thereby dispute is seemingly conceivable (Hayton, 2014). The latest negotiation process formulated into Code of Conduct initiated by ASEAN member states have brought into such an enormous progress

towards conflict settlement despite the fact that China keeps doing that sort of aggressive behaviour in the South China Sea. However, solutions and problems should be based on law but unfortunately it is not always clear which international law should be adopted (Djalal, 2014). Indonesia, one of ASEAN's biggest members considers about the need of maintaining a peaceful order in regional security more importantly when it comes to any dispute dealing with sovereignty claims and energy vulnerability. As of October 2014, Indonesia's newly elected President Joko Widodo has announced a new top priority in terms of foreign policy concern emphasizing on the importance of maritime power through officially announced vision of "Global Maritime Nexus" (GMN). Through this vision, Indonesia is expected to play a more contributive role in the formation of regional security and economic.

Research and attempts pursued by both academicians and think-tanks in order to examine state's national interests have been helpful in obtaining the significance of maritime power as one of defense strategy tools. Started from the basic assumption of world politics according to neorealist which believed that an anarchic international system is a source of conflict, thus state faced a condition to which they need to make sure that they are safe from other state's intention. In order to strive a security attainment from any plausible attack, both groups and individuals living such a constellation are therefore driven to acquire more and more power in order to escape the impact of the power of others (Herz, 1950). Thus, maximizing efforts to prepare for the worst circumstance led by insecurity is rising as no state can be certain about their security at stakes. I would argue that this action is justifiable as long as it does not threaten other neighbours. Therefore, Jervis's findings that an increase in one state's security decreases the security of others, notably known as central point of security dilemma (Jervis, 1978) might be taken into account in understanding the basic idea on analyzing state behaviour on security matter. Nonetheless, I believe that one state's security increase is not only decreasing others' security but also themselves in the first beginning. Once state 'A' increases their security preponderances by the means to make them safe from other's attack, it will trigger other states, name it state 'B' to therefore feel insecure due to its vulnerability thereby implying them to increase security as well. It will in return increase state vulnerability and automatically decrease its security.

International system which consists of states and organization established imply to the existing anarchic system, for it lacks an overarching supranational government, but is not chaotic thereby system is defined by its key actors, their interactions, hierarchies of power, and influence among them (Clemens, 1998). As the consequence of uncertain strategic situation, security dilemma is formed as a type of insecurity dynamic between states

thereby state's knowledge of the other state's motives is important in order to engage in the worst-case scenario planning (Glaser, 1997). Geoffrey Till coined an idea that sea power holds four historic attributes intimately connected with each other, and each also exhibits the same cooperative and conflictual tendencies characteristics of international relations as illustrated in the figure below (Till, *Seapower*, 2004)

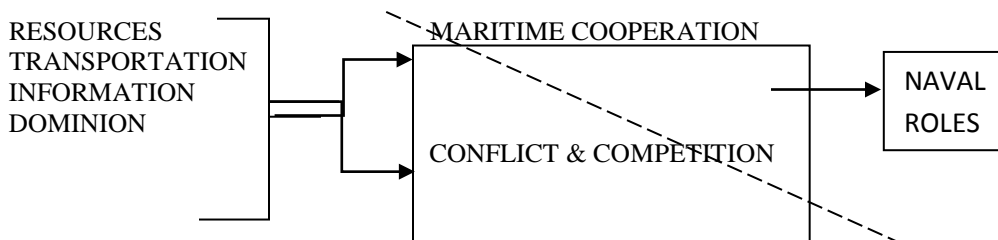

Figure 1. The Four Historic Attributes of Sea

Given the fact that sea possesses a huge amounts of resources providing high road to prosperity, the need of making the most of it also increases. In order to get enormous profits, it is important to make sure that a highly developed technology for transportation is applied. Furthermore, making sure its safety from such threats is another crucial point which needs that sort of sharing information with other actors playing within. However, dominion is seemingly inevitable since actors hold maritime strategies as Till further argued include assuring sea control, projecting power ashore in peace and war, attacking and defending trade, directly and indirectly, and maintaining good order at sea. Finally, naval roles will depend on the scale of either maritime cooperation or conflict and competition which potentially arise.

Global power projections in the south china sea

The South China Sea has turned into an area where contested primacy of major powers plays. The notion of US Rebalance to Asia vis-à-vis China Peaceful Rise which has been predominantly marked by mistrust often leads states to face security dilemma. It is therefore reflected in the defence strategy in order to ensure countries' interests from being taken by others. However, leaning to one side is not an option for Indonesia to maintain their security at stakes.



Figure 2. Map of disputed area in the South China Sea (Economist, 2015)

Picture above depicts the disputed area which has increased states' security level in the region. If parties involved keep assert their power leverage through for instance China and its reclamation at Paracel Islands, I would predict a conceivable predicament surrounding the South China Seas could grow worse in the couple years ahead.

US Rebalance to Asia

One of the most illuminating statements delivered by US Secretary of Defence Ash Carter on his remarks on the next phase of the U.S. Rebalance to the Asia Pacific is:

“Asia Pacific is the defining region for our nation’s future given a few data points: half of humanity will live there by 2050, even sooner by 2030 more than half of the global middle class and its accompanying consumption will come from there, and there is already home to some of world’s largest militaries and defence spending.” (Carter, 2015).

After U.S. ages war in Middle East, U.S. is now thinking about pivot point in Asia since it is considered as one of the key drivers of global politics. However, China’s rise has therefore led U.S. to think about strategic implication which implies into the increase of military presence which U.S. has in the region. This condition of security dilemma which occurs due to an uncertainty in international relations has worried U.S. so that expanding military presence is a critical thing to do in order to secure their interests at stake in the region. U.S. engagement in the region is seen in their involvement in the establishment of APEC Leaders’ Meeting and other form of cooperation such as ASEAN Regional Forum (ARF), ASEAN plus Three, and East Asia Summit. This form of cooperation could be interpreted as insecurity dynamic reflection in U.S.’ strategy by knowing other state’s motives better so that they could engage in the worst-case scenario planning

due to the rise of China. U.S. also needs to ensure their energy security as Kent Calder, an American scholar has argued that the “radical energy vulnerability” of key states in the region and the rise of China as both “an emerging superpower and an emerging competitor...for potentially tight regional energy supplies” compounds the potential for energy to become a “catalyst for regional conflict” (Calder cited in Stares, 2000). It therefore suggests the idea proposed by Till (2004) on how resources drives state to either engage in any sort of maritime cooperation or conflict and competition. U.S. somehow plays a seemingly more balance action by establishing cooperation despite the fact that this condition might trigger competition in the region due to the unbalance economic power between U.S. and other Asia Pacific regions mostly developing states.

China Peaceful Rise

China as one of regions’ wealthiest country still needs its dependence on imported sources of energy. Since 1993 they have been a net importer of oil and since 1996 has become a net importer of crude oil. The major Asia Pacific sources were Indonesia (6.30 Mt) and Vietnam (1.01 Mt) and it will likely continue to grow in the future (Shixian, 2000). Table below illustrates the energy net import projections of China:

	Unit	2000E	2010E	2015E
Energy Net Import	Mtce	27.00-33.37	124.04-146.41	226.23-291.13
Coal	Mt	2	4	5
Oil	Mt	35.00-40.00	90.00-103.00	125.00-145.00
Natural Gas	Bm ³	1.2-2.0	17.0-22.0	60.00-90.0

Figure 3. The energy net import projections of China

Source: Author’s projection based on *China’s statistical Yearbook 2010* (Shixian, 2000)

NOTE : Coal net import is minus; it refers to net export

E: Estimate; bm³: billion cubic meters, Mtce: million tons of coal equivalent; Mt: million tons.

This situation, in turn, will contribute and complicate the problem of existing maritime boundary dispute in the South China Sea as China’s heavily dependence on the energy import from Southeast Asia countries is facing U.S. who also asserts their rebalance in Asia, more specifically to the importance of future energy demand. It is worth noting that what is unfolding in Asia is a race between the accelerating dynamics of multipolarity, which could increase the chances of conflict, and the growth of mitigating factors which will dampen and improve potential continuing peace on the region (Friedberg, 1993-1994). The dynamic of security dilemma-driven action-reaction is seen in the economic and military competition which both US and China assert. Given the high tension of competition, both states actually need to make sure that their policy and

actions over the South China Sea is in line with the principle of peace. Miscalculation would lead into the risk of unintended escalation in the future. Even though China keeps insisted that they will never jump into the harsh conflict when it comes to any dispute, yet their behaviour through People Liberation Army (PLA) modernization and other assertive responses in the South China Sea showed that they hold huge amount of interests at stake there. Fu Ying, a spokeswoman for the National People's Congress on March 3, 2015 stated that:

“As a large country, China needs the military strength to be able to protect its national security and people as our history teaches us a lesson that when we lag behind, we come under attack. We won't forget that. Furthermore, we need to continue modernizing armed forces since there was still a gap between us and other countries in terms of military equipment” (The Wall Street Journal, 2015)

It strongly depicted a possibility of arm races in the region which may involve China and U.S. as the regions' most powerful actor. In regard to the South China dispute, China persistently shows an assertive behaviour seeing by the latest reclamation done in the Spratly Islands. This has raised U.S. concern by Republican Senator John McCain and Democrat Jack Reed who sent a letter to U.S. Secretary of State John Kerry and U.S. Defence Secretary Ash Carter by stating that U.S. should build a strategy that includes measures to “slow down or stop China's reclamation activities there by whether releasing intelligence about this activity more frequently or stop certain types of security cooperation with China is they don't stop (Brunnstrom, 2015). Indonesia as one of the natural leaders in the region tries to response the heightened power competition between U.S. and China in these particular situations by enunciating maritime cooperation which may lessen the possibility of great power projections in the region as states are more likely to cooperate instead of competing.

Economic and security interests vis-a-vis non-claimant status

Indonesia has declared its position as a non-claimant state in regards to the South China Sea dispute. It is stated on Indonesian President Widodo statement in an interview with the Yomiuri newspaper:

“One of China's claims to the majority of the South China Sea has no legal basis in international law, but Jakarta wants to remain an “honest broker” there. We need peace and stability in the Asia Pacific region. It is important to have political and security stability to build up out economic growth. So we support the Code of Conduct (of the South China Sea) and dialogue between China and Japan; and China and ASEAN.” (Widodo, 2015)

However, it does not literally mean that Indonesia has no interests at stake in the region as according to Lloyd national interests are the wellspring from which national objectives and a grand strategy flow (Lloyd cited in Sumakul, 2013). In order to prosper the nation, it is important for a country to safeguard their national interests which imply on the formulation of integrated defense and foreign policy. Indonesia has been playing an active role as honest broker during the dispute. Recent nine dashed line published by China has alarmed Indonesia as it overlaps with Indonesia's EEZ and Continental Shelf. Indonesia's vulnerable position is tested after China's nine dashed line claim overlapping Natuna Island. In July 10 2015, Head of Indonesian State Ministry of Development Planning Andrinof Chaniago and Indonesian Ministry of Defence have agreed upon an establishment of military base in Natuna Island as the means to safeguard Indonesia territorial from any plausible threats due to maritime boundary dispute in the South China Sea (KOMPAS, 2015). It shows Indonesia's effort to assert their naval roles in response to make sure its safety from the danger of power dominion at the sea.

The 1982 United Nations Convention on the Law of the Sea (UNCLOS) sets out what maritime zones may be claimed from land territory, as well as the rights and jurisdictions of states in such maritime zones (Beckman, 2015). Indonesia has been actively contributing towards a dispute settlement through its role as third party. In its annual press statement, Indonesian Ministry of Foreign Affairs Retno Marsudi emphasized that through ASEAN, Indonesia will continue to actively engage for the full and effective implementation of Declaration on the Conduct of Parties in the South China Sea (DOC), as well as the early conclusion of the Code of Conduct in the South China Sea (Indonesia, 2015). In spite of Indonesia's claim of not being a claimant at the dispute, national interests which are always detached in every country's policy action drives Indonesia to concern on their challenges and opportunities in the South China Sea. When states are facing security dilemma, a condition in which they are unsure of other intention while at some points need to reassure their positions, they would formulate some sorts of policies which involve all resources to safeguard national interests. Indonesia, however, hopes to maintain good relations with two great powers as they get benefits from these bilateral partnership. There are three layers of benefit which Indonesia will get: (1) In the South China Sea, (2) Indonesia-U.S. partnership, and (3) Indonesia-China partnership.

First, South China Sea as the semi-enclosed zone holds a huge potential resources. Being in a line where four Sea Lines of Communications (SLOC) met, really makes Indonesia lucky. It would benefit the country if government could effectively maximize all potential

covering geographic, economic, as well as political as it has been enunciated in maritime vision through GMN. The rapid economic growth which increases in demands for gas and oil has increased the need for new resources for sustaining economic development (Sukma, 2010). Not surprisingly, South China Sea becomes one of the most contested lands due to the strategic position of chokepoints which becomes a critical part of global energy security because 63% of petroleum and other world's oil production transported through maritime routes (EIA, World Oil Transit Chokepoints, 2014). Surrounded by six choke points notably known as Strait of Malacca, the Singapore Strait, the Sunda Strait, the Lombok Strait, the Ombai Strait, and the Wetar Strait which are all used for international navigations make Indonesia seems to be so lucky. Indonesia is now aware about the importance of prioritizing maritime sector as the strategy to alleviate nations' power. Moreover, one-third of the world's liquefied gas passes through the Straits of Malacca and into the South China Sea which becomes the shortest sea route between African and Persian Gulf suppliers and Asian consumers. U.S. Energy Information Administration reported that by the end of 2011, trade through Malacca was greater than 15 million bbl/d or about one-third of all seaborne oil (EIA, 2013). Thus, it becomes important for Indonesia to get benefits from this position for their trade and commerce lines. Apart from that, one of the biggest straits called Lombok Strait located in Indonesia is notably known as the wider, deeper, and less congested route than Strait of Malacca so that it will be beneficial for any trade routes. About 3,900 ships transit the Lombok Strait annually; the total tonnage carried by the Lombok Strait is 140 million metric tons worth a total of \$40 billion (Ho, 2006). It is further argued that tankers which exceed 200,000 DWT have to divert through the Lombok Strait due to the depth constraints of the Strait of Malacca.

Second layer which involves Indonesia-U.S. partnership as it is reported in the fourth Joint Commission Meeting of the U.S.-Indonesia Comprehensive Partnership on February 17 2014 will cover three pillars: political and security; economic and development; and socio-cultural, education, science, and technology (State, 2014). In supporting Indonesia's maritime vision, this partnership agrees upon some points: the selling of Apache helicopters to Indonesia in support of Indonesian Armed Forces modernization efforts to more than \$1.5 billion; Indonesia's national oil company Pertamina announced a 20 year Liquid Natural Gas agreement with U.S.-based Cheniere Energy that would bring up to 800,000 metric tons per year of abundant U.S. LNG to Indonesia for the first time; and improving fisheries management. These patterns would surely bring better prospective investments for both sides given its economic and security benefits.

Third layer involves mutual benefits due to Indonesia-China partnership. According to Rizal Sukma, Indonesian presidential adviser for foreign policy, there are at least three areas where Indonesia's maritime agenda fills in or overlaps with the Maritime Silk Road ideas of Chinese President Xi Jinping namely connectivity, safety, and diplomacy (Gokkon, 2014). In 2013 President Xi Jinping launched Maritime Silk Road (MSR) which envisages a maritime trade network stretching from Beijing, through Indonesian waters into the Indian Ocean and onto the Middle East and perhaps, as far as Europe in where Indonesia would become a major transit point for Chinese trade (Piesse, 2015). It will surely benefit both sides due to its maritime interconnectivity without disrupting the existing SLOC in the region. On March 25 2015, President Widodo at the invitation of President Xi Jinping has agreed on enhancing cooperation in these priority areas: (1) Political, defence, and security, (2) Trade, investment, and economic development, (3) Maritime, aeronautics, science, and technology, (4) Culture and social affairs, and (5) International and regional affairs (Affairs, 2015). Under China-Indonesia Maritime Cooperation Fund (MCF), both agreed to strengthen practical cooperation in navigation safety, maritime security, maritime search and rescue, maritime scientific research, and environmental protection.

Despite its non-claimant status, Indonesia perceives a threat from the realm of balance of power in the Natuna Island thereby it is critical to strive for self-defence strategy as main strategy to maintain national interests. One of the most notable defense doctrines called "Dwi Darma Nusantara" which shapes integration of military component and non-military component has been useful in guiding GMN to defense, protect, and preserve Indonesian national interest. Indonesian national defense was built upon the principles of democracy, human right, public prosperity, environmental preservation, national law, international law and custom, and peaceful live side by side and observe the principle of independence, sovereignty, and social justice (Susanto, 2007). President Jokowi is widely known as new figure in Indonesia political stage despite his previous position as the governor of Jakarta. Compared to his predecessor, Susilo Bambang Yudhoyono (SBY), who is a retired Army general, they have different focus of foreign policies. President Widodo's maritime ambition in order to transform Indonesia to be a considerable maritime power in the region has been a powerful political commitment for Indonesian naval development which covers these procurement programmes: off-shore patrol vessels, naval aviation, air defence, maritime surveillance, and anti-submarine capabilities (Gindarsah, 2014). It postulates Indonesia's new defence commitment in alleviating its maritime strategy for the pursuit of country's national interest. Even though facing security dilemma, Indonesia prefers to have maritime cooperation

instead of conflict and competition without forgetting the role of naval to safeguard the country. Therefore it proves the first argument on how Indonesia is aimed at maintaining good relations with all great powers while at the same time pursuing national interests at stake.

The significance of maritime vision towards maritime boundary dispute in the south china sea

Jalasveva Jayamahe” (in the ocean we triumph) slogan of Indonesian navy was reiterated by President Widodo in his first presidential speech on October 20, 2014. His obstinacy is supported by the appointed Indonesia’s first coordinating Minister for Maritime Affairs, Indroyono Soesilo, who will then assume oversight for the ministers for transport, tourism, energy, and fisheries (Neary, 2014). It is also strengthened by choosing Tedjo Edy Purdijatno, a navy man, in order to be Coordinating Minister for Security of Republic of Indonesia in Widodo’s government and the establishment of new ministry called Coordinating Ministry for Maritime Affairs. GMN strategy, announced by President Jokowi in his speech in East Asia Summit in Naypyidaw 2014, will be undertaken through five key actions covering maritime diplomacy to solve border dispute, safeguarding Indonesian maritime sovereignty and security, securing Indonesian natural resources, intensifying defence diplomacy, and reducing maritime rivalries between major powers through resolution of regional territorial disputes (Neary, 2014). One of the most important points on GMN concept concerning the South China Sea dispute is stated by Indonesian Minister of Foreign Affairs Retno Marsudi which signalled the intention of Indonesia to give more contribution through bilaterally driven and self-interested approach on diplomacy. It will be applied through continuing pressing on the completion of code of conduct in South China Sea between China and ASEAN (Kemlu, 2015). This vision can be considered as Indonesia’s strategy to play a more contributively role in regional basis while pursuing national interests at the same time. As ASEAN leaders, Indonesia is a strategic place for any sort of international commerce fleeing in the region. In order to apply this policy, there has to be coordinating policies around ministries to articulate the grand design of GMN for instance Ministry of Foreign Affairs, Ministry of Defence, Ministry of Maritime Affairs and Fisheries, Ministry of Transportation, and last but not least Indonesian Navy. Nevertheless, after 9 months of inauguration, each of the ministry involved in that vision has not released any official blueprint in regard to GMN implementation. In order to respond to the challenges, four broad tiers of decision-making are particularly important: policy making at the level grand strategy, grand strategy making, military policy and strategy making, naval policy and strategy making (Till, 2015).

Living in the midst of great power projections, Indonesia faces security dilemma which leads them formulating GMN as the means to reduce vulnerability and escape the impact of the power of others as Herz (1950) argued on the point of striving security attainment from any plausible attack. Despite all challenges, GMN offers a fresh air to the better opportunities for countries surrounding to cooperate. Beckman (2015) believed that the only viable prospects for resolving the maritime boundary disputes in the South China Sea would be for the Claimant States to enter into Joint Development Agreements (JDAs) which spell out the right of the claimants states to exercise rights to resources in the areas subject to the JDAs. ASEAN countries will benefit from the maritime cooperations if the vision of GMN is fully integrated by the shared opportunities on maritime-based trade and investments. One of the most prominent events which Indonesia will soon engage is their chairmanship role at the IORA (Indian Ocean Rim Association) in 2015. As Till argued on his historical attributes of the sea that transportation and information need to be taken into account in order to enhance maritime cooperation, Indonesia through its chairmanship in the IORA will therefore promote the advanced economic diplomacy through sea power. Indian Ocean will then be projected as the pearl for benefitting countries surrounding. There are some significant points proposed in the National Workshop on the Preparation for Indonesia's Chairmanship in IORA which was held on February 25 2015 at the Indonesian Ministry of Foreign Affairs; such as the issues on security and maritime safety, disaster risk management, trade facilitation and investment, fisheries management, academic and science, as well as the tourism and cultural exchange (Marsudi, 2015). All of these points are important in strengthening maritime vision and therefore alleviating the number of cooperations among countries in the region. Indonesian Ministry of Foreign Affairs Retno Marsudi further argued that as a middle power country, Indonesia's membership in the IORA is not just about what it gets, but rather what contribution can Indonesia give for the organization and world. Furthermore, ASEAN Economic Community implemented in 2015 will become the platform to enhance cooperation as well as investment in ASEAN members. The implementation of Roadmap towards an Integrated and Competitive Maritime Transport in ASEAN will strongly be suggested to benefit its members (ASEAN, 2008).

However, Association of Southeast Asia Nations (ASEAN) remains Indonesia's cornerstone of its foreign policy as described as 'the first concentric circle' thereby promoting the idea of an independent Southeast Asia capable of maintaining its autonomy in the face of rivalry is an important task to do (Sukma, Indonesia and the Emerging Sino-US Rivalry in Southeast Asia, 2015). Both Track One and informal Track Two

diplomacy efforts have been conducted in order to solve the dispute through ASEAN Regional Forum (ARF) and the discussion of Code of Conduct to formally discuss the matters between China and ASEAN in spite of Chinese's participation; while the Track Two Workshop was initiated by Indonesia to develop dialogue, confidence building, and concrete cooperative efforts and networking in the South China Sea (Djalal, *Managing Potential Conflicts in the South China Sea: Lessons Learned*, 2001). Despite ASEAN's principle of non-interference when it comes to other internal affairs (Severino, 2000), the embarrassing silence with a six-point consensus in the recent standoff between China and the Philippines over Scarborough Shoal in the South China Sea during Cambodian chairmanship on the foreign ministers' meeting has raised Indonesian sense of rescue to hammer out the six points of agreements (Emmerson D. K., 2012). In regard to the dispute, China has made series of compliments sent by the Permanent Mission of the People's Republic of China to the United Nations to the Secretary-General of the United Nations with reference to the Republic of Philippines Note Verbale no. 000228 on Spratly Island (in Tagalog : Kalayaan) which strengthened that:

“The so-called Kalayaan Island Group (KIG) claimed by the Republic of Philippines is in fact part of China's Nansha Island...The Republic of Philippines' occupation of some islands and reefs of China's Nansha Islands as well as other related acts constitutes infringement upon China's territorial sovereignty” (DOALOS, 2009).

On the other hand, the split among ASEAN members seems to be real. Indonesia who believes on the principle of “independent and active” tried to be an honest broker after Indonesian former Foreign Minister Natalegawa successfully persuaded Cambodian Foreign Minister Hor Namhong to read six-point consensus reaffirming all ASEAN foreign ministers' commitment to observe the Declaration on the Conduct of Parties in the South China Sea and follow the guidelines for its implementation. Moreover, they also need to work together toward an early adoption of a Code of Conduct to strengthen the 2002 Declaration; to exercise self-restraint and avoid threatening or using of force; and to uphold the peaceful settlement of disputes in keeping with United Nations Convention on the Law of the Sea or UNCLOS (Emmerson D. K., 2012). Split within its members is seen in Cambodia seemingly succumbing to China while U.S. supports to the Philippines through defense partnership may help them enhancing national interests. Meanwhile Malaysia, despite its status as claimant state, and Brunei agreed on maintaining some sort of cooperations with China. In June 2013 Malaysian Prime Minister Najib Tun Razak called for South China Sea claimant states to develop resources in order to protect freedom of navigation and the safe passage of shipping while Brunei and

China agreed to carry out joint exploration and exploitation of maritime oil and gas resources (IISS, 2013). It depicts a fact that the South China Sea would become a test for ASEAN unity in the regional architecture. If this fuzzy situation remain stagnant, ASEAN could end up abdicating responsibility for managing its own regional problems to big external problems (Baviera, 2012). Consensus which becomes “ASEAN’s way” of settling dispute can sometimes be difficult to be achieved as some countries seemingly satisfy their own interests. For a consensus to be absolute, however, all parties must share the same concerns and be willing to sacrifice part or all of their interests for the common cause (Nguyen, 2012).

Thus, the second argument on how maritime vision could become a strategy to enhance unity among ASEAN members suggests a condition that if all members agreed on sharing the same concerns in regard to the South China Sea dispute. As a consequence, the regional architecture would be stronger that later is expected to diminish the potential of great power rivalry in the region. In regard to the heightened global power projection in the South China Sea, some states remain benign as they see more beneficial parts on the potential maritime cooperation while others think about the danger of conflict and competition. At the ASEAN Regional Forum in Hanoi in July 2010, Secretary of State Clinton laid out seven principles guiding the US government’s policy toward the South China Sea. All of these principles are known to provide foundation, though not the sum total, of US interests in the region; these are: (1) Freedom of navigation, (2) Freedom of overflight, (3) Unimpeded commerce, (4) Peaceful resolution of dispute and abstaining from coercion, (5) Conforming claims to the UN Convention on the Law of the Sea, (6) A collaborative diplomatic process to resolve territorial dispute, and (7) Negotiation of a Code of Conduct. (Bader, 2014)

In order to ameliorate security dilemma, Lindley argued states can focus on such steps; increasing transparency and reassurance in order to reduce anarchy-induced uncertainty by sharing information about each side’s interpretation of the other’s actions (Lindley cited in Liff, 2014). However, there is no guarantee that by expanding transparency and reassurance could diminish all possibilities of potential dispute. This strategy works effectively if only all states bound into that sort of formation agreed upon shared consensus or legal foundations. U.S. who has not ratified UNCLOS yet brings an image on how US is not commitment into the major legal basis of settling dispute even though US insists their peaceful approach would be prioritized instead of arms racing there while China seems to be reluctant in implementing the signed Code of Conduct. Security dilemma is something inevitable as each country must have their interests at stake. The important point is on how these interests do not

overlap and harm other countries through that sort of dominion which might lead into conflict or competition. The idea of cooperation should rest on the equal profits enjoyed by all parties involved. Even though it is not a panacea, Indonesia's maritime vision through GMN could become a way to at least reduce the heightened global power projections and to further avoid the risk of making the South China Sea as the area for contested primacy between U.S. and China. Here are several reasons why Indonesia's maritime vision matters to provide a "buffer" solution amidst the height of great power projections. First, maritime vision as Indonesia proposed through GMN will postulate an idea that economic cooperation would be enhanced in order to bring benefits for all countries surrounding such as those bound into ASEAN as well as U.S. and China. Therefore maintaining good relationship among all actors engaged will be prioritized for the sake of mutual benefits. Jervis (1978) argued that statesmen who do not understand the security dilemma will think that money spent is only cost of building up their arms. It is further argued that adopting more conciliatory posture like meeting the other's legitimate grievances or developing mutual gains from cooperation can somehow increase state's security. Economic cooperations will lead interdependence. If one country has dependence on other, and of course this is driven by national interest, they would therefore seek to maintain a good relationship. Second, maritime security cooperation will provide a space for both great powers and ASEAN members who are mostly developing states to discuss about security threats that they are facing. Considering ASEAN Regional Forum (ARF) as multilateral forum, it may be able to help creating a 'situation of equilibrium' among the major powers through the creation of norms and habits of cooperation as to some extent, the ARF is more about engaging the U.S. as engaging China (Acharya, 2001). Moreover, space for sharing information would be better established so possibility of suspicion that usually leads into conflict or competition can be avoided. One of the principles of GMN is to enhance security cooperations with great powers in order to secure the SLOC as it is crucial for all countries involved in the trade and investments there. So maritime vision could be helpful in mitigating the risk of heightened great power projections as all countries share same burden as well as opportunities through a formal partnership on the basis of maritime cooperations.

Conclusion

South China Sea dispute is predicted to be a contested primacy zone for great power projections such as U.S. and China in order to gain their interests at stake in the region due to its potential resources. Security dilemma faced by sovereign states surrounding could possibly lead into two possibilities; either cooperation or competition. The South China Sea

dispute is somehow a test for all actors involved; for China it assesses their commitment to keep relying on the principle of ‘‘China Peaceful Rise’’ without triggering any assertive competition, for United States it tests their limits on presenting ‘‘U.S. Rebalance to Asia’’ without disrupting regional order, and last but not least for Indonesia to successfully achieve their national interests without being involved in worsening conflict escalation. This predicament has led Indonesia as one of regional prominent actors who commits to be non-claimant state to strive for a more cooperative solution in order to reduce the vulnerability of countries surrounding through its maritime vision formulated in Global Maritime Nexus (GMN). Despite challenges and opportunities, GMN could become a buffer solution to enhance unity among ASEAN members since some members become claimant states. Moreover, it would be a mutually beneficial solution for all states involved in the South China Sea dispute to possess shared opportunities due to the maritime cooperations that will allow them to have better transportation and information sharing systems to reduce the potential risk of great power dominion. Therefore, maritime vision invigorated by Indonesia could avoid the undesirable outcomes such as arms races by naval power as states will have a more formal space to know other intentions’ so that direct conflict in settling any dispute might slightly be reduced.

References:

- Acharya, A. (2001). *Constructing A Security Community in Southeast Asia*. Oxon: Routledge.
- Affairs, C. M. (2015, March 26). *Joint Statement on Strengthening Comprehensive Strategic Partnership between the People's Republic of China and The Republic of Indonesia*. Retrieved July 24, 2015, from Ministry of Foreign Affairs of the People's Republic of China: http://www.fmprc.gov.cn/mfa_eng/wjdt_665385/2649_665393/t1249201.shtml
- Anwar, D. F. (2013, February 26). *An Indonesian Perspective on the U.S. Rebalancing Effort toward Asia*. Retrieved June 29, 2015, from The National Bureau of Asian Research: http://nbr.org/downloads/pdfs/outreach/Anwar_commentary_02262013.pdf
- ASEAN. (2008). *ASEAN Economic Community Blueprint*. Retrieved July 11, 2015, from ASEAN: <http://www.asean.org/archive/5187-10.pdf>
- Baviera, A. S. (2012, July 26). *South China Sea Disputes: Why ASEAN Must Unite*. Retrieved July 24, 2015, from East Asia Forum: <http://www.eastasiaforum.org/2012/07/26/south-china-sea-disputes-why-asean-must-unite/>

- Beckman, R. (2015). Maritime Boundary Dispute in the East and South China Seas . In CSIS, *Forging A Common Maritime Future for ASEAN and Japan* (p. 28). Jakarta: CSIS.
- Brunnstrom, D. (2015, March 20). *Senators Seek U.S. Strategy to Stop China's South China Sea Reclamation*. Retrieved July 21, 2015, from Reuters: <http://www.reuters.com/article/2015/03/20/us-usa-china-southchinasea-idUSKBN0MF2SQ20150320>
- Clemens, J. W. (1998). *Dynamics of International Relations* . Oxford: Rowman & Littlefield Publishers Inc.
- Clinton, H. (2011, October 11). *America's Pacific Century*. Retrieved July 18, 2015, from Foreign Policy: <http://foreignpolicy.com/2011/10/11/americas-pacific-century/>
- Defense, U. D. (2015, April 06). *Secretary of Defense Speech*. Retrieved July 24, 2015, from U.S. Department of Defense: <http://www.defense.gov/Speeches/Speech.aspx?SpeechID=1929>
- DOALOS. (2009). Retrieved from http://www.un.org/Depts/los/clcs_new/submissions_files/mysvnm33_09/chn_2011_re_phl_e.pdf
- Economist, T. (2015, May 2). *The South China Sea-Sea of Troubles*. Retrieved June 11, 2015, from The Economist: <http://www.economist.com/news/leaders/21650122-disputed-sea-growing-security-nightmareand-increasingly-ecological-one-sea-troubles?zid=306&ah=1b164dbd43b0cb27ba0d4c3b12a5e227>
- EIA. (2013, April 4). *The South China Sea is an important world energy trade route*. Retrieved July 20, 2015, from U.S. Energy Information Administration: <http://www.eia.gov/todayinenergy/detail.cfm?id=10671>
- EIA. (2014, November 10). *World Oil Transit Chokepoints*. Retrieved July 20, 2015, from U.S. Energy Information Administration: http://www.eia.gov/beta/international/analysis_includes/special_topics/World_Oil_Transit_Chokepoints/wotc.pdf
- Emmerson, D. K. (2012, July 29). *Beyond the Six Points: How Far will Indonesia Go?* Retrieved July 25, 2015, from East Asia Forum: <http://www.eastasiaforum.org/2012/07/29/beyond-the-six-points-how-far-will-indonesia-go/>
- Emmerson, D. K. (2012, July 24). *Indonesia Saves ASEAN'S Face*. Retrieved July 12, 2015, from ASIA TIMES Online: http://www.atimes.com/atimes/Southeast_Asia/NG24Ae01.html
- Friedberg, A. L. (1993-1994). Ripe for Rivalry: Prospects for Peace in a Multipolar Asia. *International Security*, 18, 28.
- Gindarsah, I. (2014). *Indonesia's Maritime Doctrine and Security Concerns* . Singapore: RSIS NTU.

- Glaser, C. L. (1997). The Security Dilemma Revisited. *World Politics*, 50, 177.
- Gokkon, B. (2014, December 03). *China and Indonesia's Maritime Agendas Closely Aligned* . Retrieved July 06, 2015, from JakartaGlobe: <http://thejakartaglobe.beritasatu.com/news/china-and-indonesias-maritime-agendas-closely-aligned/>
- Ho, J. H. (2006). The Security of Sea Lines in Southeast Asia . *Asian Survey*, 46, 3.
- IISS. (2013). *The Annual Review of World Affairs*. Oxon: Routledge.
- Indonesia, M. o. (2015). Annual Press Statement Ministry of Foreign Affairs . Jakarta, Indonesia: Ministry of Foreign Affairs Republic of Indonesia . Retrieved from <http://www.kemlu.go.id/Documents/PPTM%202015/PPTM%202015%20ENG%20FINAL%20PDF.pdf>
- KOMPAS. (2015, July 10). *Pemerintah Akan Bangun Pangkalan Militer di Perbatasan Laut Tiongkok Selatan*. [Government will Build Military Base in South Tiongkok Sea Border]. Retrieved July 11, 2015, from KOMPAS: <http://nasional.kompas.com/read/2015/07/10/14595611/Pemerintah.Akan.Bangun.Pangkalan.Militer.di.Perbatasan.Laut.Tiongkok.Selatan>. [In Indonesian]
- MarEX. (2015, May 23). *Indonesian President Rejects China's Nine-Dashed Line*. Retrieved July 15, 2015, from The Maritime Executive: <http://www.maritime-executive.com/article/indonesian-president-rejects-chinas-nine-dashed-line>
- Marsudi, R. (2015, April 14). RI Foreign Minister : IORA Can be Designed to Become More Strategic. *VIII*. Retrieved from Tabloid Diplomasi.
- Nguyen, H. H. (2012, July 27). *Time to Reinterpret ASEAN's Consensus Principle*. Retrieved July 11, 2015, from East Asia Forum: <http://www.eastasiaforum.org/2012/07/27/time-to-reinterpret-asean-s-consensus-principle/>
- Piesse, M. (2015). *The Indonesian Maritime Doctrine : Realising the Potential of the Ocean* . Canberra : Future Directions International .
- Severino, H. M. (2000, July 3). *Sovereignty, Intervention, and the ASEAN Way*. Retrieved July 22, 2015, from ASEAN: <http://www.asean.org/resources/2012-02-10-08-47-56/speeches-statements-of-the-former-secretaries-general-of-asean/item/sovereignty-intervention-and-the-asean-way-3-july-2000>
- Shixian, G. (2000). China. In P. B. Stares (Ed.), *Rethinking Energy Security in East Asia* (p. 47). Tokyo, Japan: Japan Center for International Exchange (JCIE) .

- State, U. D. (2014, February 17). *U.S.-Indonesia Fourth Joint Commission Meeting*. Retrieved July 25, 2015, from U.S. Department of State: <http://www.state.gov/r/pa/prs/ps/2014/02/221714.htm>
- Sukma, R. (2015). *Indonesia and the Emerging Sino-US Rivalry in Southeast Asia*. London: LSE.
- Susanto, M. D. (2007). *Indonesia Defense Diplomacy Current Challenges Internal & External*. Jakarta : Department of Defence.
- Till, G. (2004). *Seapower*. Oxon: Frank Cass Publishers.

REEVALUATING PREVIOUS CONCEPTS OF “THE NATION”

Izolda Takács, M.A. Sc.

University of Pecs, Hungary

Doctoral School of Human Sciences, PhD Program in Sociology

Abstract

In my hypothesis the concept of the nation is present, and it could be defined precisely in Széchenyi's work. The aim of my paper is to prove, or to cast way this hypothesis. My statement will be supported by quotes from Széchenyi. In my opinion our image and concept of the Hungarian nation has been made up by nation concepts like these. They come to the forefront more and more. Namely, the analysis of the nation concept of the “greatest Hungarian” could make us more aware of the genealogy of our Hungarian national consciousness.

Keywords: Sociology, politics, Hungarian, Széchenyi, nation, national

According to Gyula Szegfű in *The Széchenyi of Today*, people can carry great significance in time even if their actions do not provide posterity with any practical benefits. The life of a nation is not advanced by material gains; financial gain does not automatically carry a nation forward to new and more splendid heights. This is something which is achieved through the proliferation of thoughts and feelings connected to the community.³³

Even setting aside the practical achievements of Széchenyi (such as the construction of the Chain Bridge, the Academy, regulating the River Tisza, creating steamboat transportation on the Danube river and Lake Balaton for example), his persona still remains so decisive, that it is hard to find anyone similarly significant amongst the generations of Hungarians that followed him.³⁴ What he thought about the Hungarian nation is still something that deeply interests not only historians researching his life work and sociologists but all those who investigate what being Hungarian actually means. The answers to this question are many and controversial, whether it refers to characteristics of intellectual or public life. Indeed, we find radical

³³

SZEKFŰ, Gyula, *A mai Széchenyi*, Bp., Révai, 1935, 23.

³⁴

See, id. at., 23–24

forms of contradicting views merging in every important question relating to the definition of Hungarianness. *The answers are different and the thoughts often arguable.*³⁵ Even the dictionary definition of the word “Hungarian” sounds different and contradictory when uttered by different lips. And yet we must constantly question what being Hungarian actually means. In 1936 it occurred to the people working at the editorial of *Magyar Szemle* to publish a collection of essays on the topic. The idea was put forward by the very same Szekfű Gyula whom I have already mentioned. He believed the goal was “to mark the boundaries beyond with which the so-called Hungarian problem could be dealt with the light-mindedness of fantasy and poetry, but within which it would be possible to get closer to and understand the essence of Hungarianness with the help of objective methods and instruments.”³⁶

But when we are faced with different life works, and the different worlds connected to these, we are forced to acknowledge that the only thing we can get answers to is what being Hungarian and the Hungarian nation itself meant in a given age. This also means that providing an answer to the later question is therefore methodically and contextually possible.

My research essentially starts out from the problem posed by defining national characteristics. In my essay I will analyse and weigh the conceptual basis of the term nation and its connotations. While exploring the question I will demonstrate how Széchenyi used the term of the nation and what he himself meant by it.

In order to answer this, I will take a close look at some of his major works, mainly *Hitel* (Credit), *Világ* (The World) and *Stádium* (The Stage) but I will also turn briefly to some of his other writings. To be able to most appropriately interpret the way Széchenyi used the term in his works I will apply discourse analysis to support my assertions with examples taken from his texts.

I believe that our idea of what it means to be Hungarian, our present state, our knowledge, stems from such concepts of citizenship and that in fact there is a growing focus on these issues in current times. Investigating what “the greatest Hungarian” considered to be the essence of a nation can help us become conscious of the genealogy of how we have come to view being Hungarian today.

At the end of my essay I will analyze the significance of István Széchenyi in current times, in the same way Gyula Szekfű did when he reviewed the works of 'the greatest Hungarian'.

First of all I have to point out that the aim of Széchenyi's works was not to define the concept of the nation or describe it factually:

³⁵ Source: <http://mek.oszk.hu/05000/05049/html/gmbabitsmagyar0001.html>

³⁶ MISKOLCZY, Ambrus, „*Mi a magyar?*”, Századok, 1998, 6. sz.

“Now I wish only to discuss the subjects of money, commerce and economics and therefore these are in general the only topics that shall be touched upon. Whether it shall occur that I mix in anything else, I myself do not know, but it could easily happen...”³⁷

“I have been so bold as to present the public with four short pieces of work in the past five years. All of them were aimed at raising awareness and demonstrating that much improvement is urgently needed in terms of our constitution, our customs and the situation of our middle classes.”³⁸

Such a broad conceptual framework paves the way for possible misunderstandings. Therefore, (and also to prevent the analysis from becoming anachronistic) I must ensure that I do not in any way attribute thoughts to the author which he did not actually express either because he had no intention to or because a certain interpretation of his words was at the time not yet available to him.

I must also keep in mind that the meaning of certain keywords could have altered with time, and so the author might have been using them with a different connotation than would be attributed to them by a reader today.³⁹ Some terms might completely disappear from use or their meaning might change. Jorge Luis Borges refers to the definition constructed by Bertrand Russell which states that the objects of the outside world are none other than radiating circular systems of possible impressions. In connection to this Borges writes that “the same is true of any text, considering the incalculable reflections caused by words.”⁴⁰

The general definition of the concept of the nation.

By narrowing down the investigation of the concept of the nation to but one period - namely the Reform Age - we can eliminate the problems stemming from the shift in the connotation of the word through time. However it does not help us dispose of the threat posed by the confusion surrounding the concept itself which threatens each and every attempt made at investigating a certain notion within a historical context.⁴¹

³⁷ SZÉCHENYI István, *Hitel*, Bp., Neumann Kht., 2002. Forrás: <http://mek.niif.hu/06100/06132/html/index.htm> 20.02.2012.

³⁸ SZÉCHENYI István, *Stádium*, Bp., Neumann Kht., 2002. Forrás: <http://mek.niif.hu/06100/06135/html/index.htm> 20.02.2012

³⁹ See at Quentin SKINNER, *Jelentés és megértés az eszmetörténetben = A koramodern politikai eszmetörténet Cambridge-i látképe*, Szerk. HORKAY HÖRCHER Ferenc, Pécs, Tanulmány, 1996.

⁴⁰ See Jorge Luis BORGES *válogatott művei II.: Az örökkévalóság története*, Bp., Európa, 1999, 71.

⁴¹ See at Quentin SKINNER, *i. m.*, 17.

The first step therefore would be to establish an ideal version of the concept compared to which we can then reconstruct what the nation meant to the aristocracy in the Reform Age.

Even today there is no standard definition of what a nation actually is.⁴² There are a lot of disagreements, and there have been and still are several theories in connection with the phenomenon. There are but a few words which are used by as many and yet understood by as few as the words nation and nationalism.⁴³ According to a current broad encyclopedic definition a nation entails a politically coherent people capable of forming a power structure.

In the long line of works dealing with the issue of nationalism the volume titled *Ideas in politics: nationalism* without doubt occupies an illustrious place. In its attempt to explain the concept of the nation one can sense the pursuit of the *communis opinio doctorum*. It states that most people have come to accept that the nation is something that belongs in the realms of culture and/or social psychology.

To some who research the concept, the nation is a more or less artificial construction: it is an “imaginary society” (Anderson) which is sovereign yet constrained by limitations. Others consider it to be a vast, anonymous, cultural unit which switches off all mediatory factors (Geller). Still others consider it to be an ethnic group with its own consciousness (Connor). According to the cited authors therefore, the “nation” as the principle of sociocultural organization or a cultural concept must be strictly separated from the state, which is characterized as the autonomous public agency of a given group (Tivey).⁴⁴

From the point of view of the theory of science of course a number of other problems arise. We cannot forget that European history and political science itself differentiates between the objective and subjective versions of nation perception. The subjective (French) concept is pervaded by strong individuality, belonging to the nation; national unity is determined by

⁴² The so called Jürgens-report contained a section according to which there is no standard, generally accepted legal definition of the term nation in Europe. To clarify the problem the ETPK appointed György Frunda Romanian senator to investigate the question, prepare a report and draw up a draft proposal. The ETPK voted on the report and accepted the draft proposal on January 26th 2006. The report took a look at the constitution of 35 states regarding how they defined the nation and how the term was institutionalized. Besides this the General Assembly assessed whether the reevaluation and modernizing of the nation concept where appropriate could help in dealing with how to national minorities and the question of their rights in the 21st century. The Funda-report – contrary to the Jürgens-report – considered the cultural and political approach to the nation equally valuable.

⁴³ See at *Eszmék a politikában: a nacionalizmus*, Szerk. BRETTER Zoltán, DEÁK Ágnes, Pécs, Tanulmány, 1995.

⁴⁴ See *id.*

personal choices and a sense of strong emotional attachment. In contrast to this, in the spirit of the German concept, the so-called objective concept of the nation is defined by objective traits such as origin of birth, language and history.

The level of awareness of independence shown by members of a nation, their faith in their uniqueness, what they believe about their merit and their sense of belonging, their feelings and self-consciousness all depend on ancestry, historical experience, traditions, independent language and culture. We must keep in mind that I am referring here to the 19th century French and German concepts.

According to another approach, differentiation exists between cultural nations and so-called state nations.⁴⁵ Marxism⁴⁶ for example, understands the nation as historical destiny. It is the historically evolved lasting proximity of humans which presupposes a shared language, public body, economics and culture.

It is not my aim to list here all the existing theories and definitions which were created in connection with this versatile concept. I have merely pointed to some of the existing arguments. And by doing so – prior to the in-depth investigation of the topic – I have also given the essay a general theoretical framework. No single definition of the nation can be the categorical imperative; it is however worth trying to identify the mentioned criteria when looking at the domestic academic approaches to the concept.

Historical, social, and political context.

If Széchenyi stated something intentionally, “it follows that any accurate description of his intended purpose can inevitably only be provided with the use of terms he himself could have used at least in theory to describe and categorize his actions.”⁴⁷

To be able to analyse the statements and works of the author, it is necessary for me to characterize the political and economic context of the

⁴⁵ The definition of “cultural nation” and “political nation” was invented to bridge the gaps in development for in these the whole of the historical progress could be accumulated. The two terms are equal, they express the same middle class based society but at the same time they acknowledge historical differences.

⁴⁶ “The social revolution of the nineteenth century cannot take its poetry from the past but only from the future. It cannot begin with itself before it has stripped away all superstition about the past. The former revolutions required recollections of past world history in order to smother their own content. The revolution of the nineteenth century must let the dead bury their dead in order to arrive at its own content. There the phrase went beyond the content – here the content goes beyond the phrase.” Karl MARX, *Louis Bonaparte Brumaire tizennyolcadikája = Karl Marx és Friedrich Engels művei*, VIII., Bp., Kossuth, 1962 (Karl Marx és Friedrich Engels művei, 8), 102.

⁴⁷ Quentin SKINNER, *i.m.*, 11.

given age which in this case is the Reform Period. This is important since it provides us with relevant information regarding the limits of the society in which he lived.

It can also help us answer in what form the concept of the idea of nation had emerged in the given period, perhaps thus conveying the reasons for the author's use of the term. The term 'nation' can carry multiple meanings not only from an ideological point of view but also depending on the age in which it was used.

According to the general notion in the Reform Age, the form of nation based on the middle classes did not come into existence by simply abolishing the previous form which had been structured purely on the aristocracy. Instead, by broadening and somewhat reforming the existing framework, the nation came to incorporate a part of society which had previously lacked all rights. The dedicated reformers who wanted to renew the Hungarian society and economy aimed to win the villeneage as their ally.⁴⁸ Their ultimate goal was to create a community by expanding the existing set of rights in which as many people as possible could live in freedom and financial security. They believed that the aristocracy-based community would thus have to be replaced by one which encompassed the whole of the nation.

In France, the process in which the different parts of society merged together to form a unified nation had already taken place by the end of the Middle Ages and in Western Europe citizenship and belonging to the nation was something that more or less overlapped. This meant that the nation as such was already understood as a state nation. In Central and Eastern Europe a number of peoples existed within the framework of a given state. The conversion of these groups into one nation and nationalism as the ideology which supported the process can be traced in their culture, most of all in the existence of a shared language community.

We can say therefore that the formation of the Hungarian nation basically carries traits typical of a culture state yet defying it as a single political body is what the uniquely Hungarian approach to the state nation derives from. This peculiarity is also apparent in the way liberal ideologies were only ever able to partially dissolve the tension arising as a result of the process which lead to the development of the nation.

According to István Bibó the basic problem of the historical Hungarian nation was that the language within the historical framework of the

⁴⁸ A villain did not belong to the noble based nation regardless of whether he spoke Hungarian or not. According to the rank oriented approach of the previous centuries every privileged member was a part of the noble based nation regardless of the language that he spoke.

state was only in part Hungarian and the different interests of the small nations were all simultaneously present.⁴⁹

After the expulsion of the Turks the Hungarians would still occupy the same historic territory as before, yet now they lived amongst groups of Germans, Slavs and Romanians who together constituted the majority of the people. Bibó believed the illusion professed by the representatives of different national movements has to be abolished. This is the belief that democratic freedom could possibly create national unity within the borders of Hungary.

This problem was heightened most by the events of the revolution and war of independence of 1848-49 when fighting against the Habsburgs became all the more difficult because the government simply could not establish a joint stance with any of nationalities living in the South and South-Eastern parts of the land. "Therefore Hungary, while fighting for freedom, found itself up against not only the backlash from the European powers but also the discontent of its own nationalities which eventually resulted in the catastrophe of 1849."⁵⁰

We must add that academic literature distinguishes between three different approaches to Hungarian "nation-building": The first one is defined as a structure-modernizing one; the second is referred to as the romantic-autopoietic type while the third is regarded as the etathist-position (statism) defending concept.

Széchenyi is considered to represent the first of the three as does, in a slightly different way, what is called the literary "Deák party" marked by the names of Eötvös and Csengery. The central figures of the romantic-autopoietic concept are Kossuth and Petőfi. The third large "nation-building" concept is represented by the Liberal Party of Tisza and the ideologists belonging to this political group.⁵¹

These different approaches will serve as my starting point. Keeping in mind the varied definitions of nation and knowing the political and economic context of the given society we could refer to them as the local focus points: power-knowledge-experience. In the next part of the essay I will try to find substantive similarities or analogous themes in the nation concept used by Széchenyi and those of other authors, while describing exactly how Széchenyi himself used the term.

⁴⁹ BIBÓ, István, *A kelet-európai kisállamok nyomorúsága* = B. I., *Válogatott tanulmányok 1945–1949*, II, Bp., Magvető, 1986, 203.

⁵⁰ See id.

⁵¹ KISS Endre, *Über die politische psychologie des stalinismus*, Forrás: <http://www.pointernet.pds.hu/kissendre/politikaelmelet/20041130151050685000000437.htm> 1 2004.12.01

Széchenyi's nation concept.

*“Our life is a series of compliances. In other words, it is the school of forgetting.”*⁵²

Before I start debating what the nation actually means in the light of the expressions used by Széchenyi, I believe it is important to highlight that in this case too we must reckon with the danger posed by a certain version of "conceptual parochialism" (Skinner). I am referring to the possibility of the analyst reproducing a certain argument by using parts of a text the author had originally constructed with a different intent by arranging these elements into a misleadingly familiar form after stripping them of their original context.

“A thought without its context can be understood only obscurely, if at all.”⁵³ That is why the ideas to be interpreted must be examined within their own textual context, the context of the complete work and the complete life work of Széchenyi. In other words, we must not examine solely the meaning of the words, but also how they were used.⁵⁴ In discourse analysis what is actually spoken must be reconstructed together with what is concealed within the communication. We must also pay attention to the position of the person speaking and to the institutional context of which he is a part.

Széchenyi did not belong to the great retrospective analysts. He accepted the given situation as a starting point and believed that the nation must leave its history behind.

*“...a smart man does not look behind his back as often as he does ahead and instead of crying for his lost treasures he glances at and examines that which he has been able to save....(and having gradually become content therewith he strives to obtain more.) And yet still, many do weep for the good old times almost completely forgetting about the present, which is why they are unable to make wise use of it. Yet, excepting the charm of antiquities, nothing can make the times of our ancestors more desirable to us than the very days of our own lives.”*⁵⁵ *“There is no greater torment than reminiscing over happy days amidst misery we ourselves have caused.”*⁵⁶ *“And we should not want to summon back to life once again that which has already passed.”*⁵⁷

But Széchenyi did not deny the importance of a shared past as a unifying force and one which can therefore contribute to the growth of the nation. He understood that it is a source of courage, one which creates a bond

⁵² Jorge Luis BORGES, *i. m.*, 48.

⁵³ STEIGER Kornél, *Lappangó örökség: Fejezetek a preszókratikus filozófia antik hagyomázásának történetéből*, Bp., Józsoveg mőhely, 1999, 9.

⁵⁴ Quentin SKINNER, *i. m.*, 18.

⁵⁵ SZÉCHENYI István, *Hitel...*, *i. m.*

⁵⁶ SZÉCHENYI István, *Stádium...*, *i. m.*

⁵⁷ SZÉCHENYI István, *Hitel...*, *i. m.*

and helps the rise of the middle classes. In this sense we see certain similarities with the nation concept used by Ernest Renan.

*“...underneath the dust of Visegrád and amongst the old walls of Buda the decor of our nation has already been buried, for the signs of such greatness can only inspire us with hope of the coming of a dawn more splendid.”*⁵⁸

*“...the many dangers, misery borne together, blood spilled for one cause binds together more strongly those who share one destiny, it brings the servant closer to his master, and so, when mankind has become thus more tame, more noble [...] let us once again warm up the heroic spirits of the middle ages but not so that we hunt each other locked away in castles and serve as the greatest obstacle to the rise of the middle classes.”*⁵⁹

It was Ernest Renan who perhaps most vehemently asserted the role of amnesia in the birth of a nation. In his essay titled *What is the nation?* he claims “forgetting, what more, historical misapprehensions are basic factors in the creation of a nation”.⁶⁰

The two nation concepts are also similar in the way they view the past. Renan defined historical events as elements which bind people and help the birth and strengthening of the nation. *“A heroic past, great men, glory (real glory) – these are the basic resources of society upon which the principle of the nation can be built.”* *“National soul: an intellectual principle...the only extreme kind of solidarity of which the sacrifices brought by our ancestors and those which we are ready to make twofold in the future constitute an important component. It assumes the past yet it is mounted in the present...”*⁶¹

Now that we have begun dissecting the role of history, it is worth lingering here for a moment. The dialectics of remembering and forgetting and the determining importance of these have been analyzed most extensively by Friedrich Nietzsche in his work titled *On the Advantage and Disadvantage of History for Life*. Nietzsche refers his statements to a given people's, nation's historical consciousness. *“A nation needs history and it also needs the appropriate handling of the events of its history, yet without the ability to forget it is quite impossible to live at all.”*⁶² *“We would serve history only so far as it serves life; but to value its study beyond a certain point mutilates and degrades life: this is a fact, the experiencing of which in*

⁵⁸ See id.

⁵⁹ SZÉCHENYI István, *Stádium...*, i. m.

⁶⁰ Ernest RENAN, *Mi a nemzet?* = *Eszmék a politikában: a nacionalizmus*, Szerk. BRETTNER Zoltán, DEÁK Ágnes, Pécs, Tanulmány, 1995, 171–187.

⁶¹ See id.

⁶² Friedrich NIETZSCHE, *A történelem hasznáról és káráról*, Bp., Akadémiai, 1989, 31.

connection to the marked symptoms of our time is as necessary today as it might be painful."⁶³ *"The fact that life needs the service of history must be as clearly understood as that excessive study of history damages the living."*⁶⁴

To get somewhat closer to Széchenyi's definition of the Hungarian identity we should also add to my essay a brief analysis of the conditions in which Széchenyi lived. It is easy to see that doing so is inevitable to fully investigate our initial topic. Besides trying to understand the texts and doctrines themselves we must also draw on the intellectual autobiography if we want to find an answer to what kind of connection exists between what the author said and what we believe he wanted to express with his words.⁶⁵

It is commonly known that his trip to England was what made the biggest impression on Széchenyi. *"He came to love the castles in the English countryside, the existence of order, discipline, rationality, the fact that everybody had rights and obligations, that everybody paid taxes, that there were no bondsmen in England who supported their masters, and that instead, everybody worked for himself, counted and traded for himself."*⁶⁶ Széchenyi's first plans for reform were therefore born mainly from his familiarity with the situation in Hungary and his desire to achieve the kind of better circumstances he had experienced abroad.

After returning home⁶⁷ he launched himself into Hungarian public life. Due to his aristocratic upbringing he discarded the views of the gentry, the nationalism of the nobles from the onset. Yet he would also differ in his opinion from his aristocratic peers in the way he believed that the revival of his own class could only be achieved by raising the whole of the people to prosperity.

Although he attacked the aristocracy with passionate words, he did so with the intent to improve his class for he believed that eventually it should lead the nation. *"We, the owners of land, should advance the economy, trade, we should explain the topics better and better, let us teach, let us enlighten each other, and let many of us join forces...!"*⁶⁸ He saw the aristocratic constitution as the biggest obstacle to development and the fact that the basic principles coded in it could not be changed. Rights were the

⁶³ See id. at 27.

⁶⁴ See id. at 37.

⁶⁵ Quentin SKINNER, *i. m.*, 13.

⁶⁶ SZEKFŰ Gyula, *i. m.*, 6.

⁶⁷ Széchenyi consciously prepared for the new life through self-improvement and trips abroad. His journey to England was what had made the biggest impact on him. Making use of his fresh experience and his own reflexions on these he would go on to draw on several of the issues of the Hungarian society in his works.

⁶⁸ SZÉCHENYI István, *Hitel...*, *i. m.*

privileges of lords, while the bondsmen had to carry the weight of the obligations. Due to the unbridgeable distance between the classes a true nation, and national sentiment, could not be born.

Széchenyi emphasized above all else that the basis of a nation must without doubt be the revival of the economy but that the revival of the economy should not only be based on labour but labour well organized, directed by none other than sense and reason, “*educated brows*”. He believed “*work well organized, in other words, intellect, is the keystone of the national economy.*”

“... the Almighty has granted us the chance to live in a century in which it is not boundless bravery, fired up imagination and physical strength which constitute the lasting corner stones of nations but the virtues of the bourgeois and the enlightened human mind [...] And a dark future will only manifest itself as carmine coloured in the distance if Hungarians evolve to perfection through non-other than intellect used to serve the interests of the public.”⁶⁹

Besides the economy and well-educated people, Széchenyi also considered national spirit and individual national characteristics to form the basis of the nation. These were considered undeniably important so far as they did not obstruct the possibility for development and bar the course of progress.

He thus clearly committed to the thought that it is wrong to seclude the civilized foreign parts of the world, because doing so condemns the given country to poverty whereas financial growth is the necessary and indispensable condition of freedom. Freedom and property are mutually interdependent:

“And new is not bad since it is new and could therefore be both good and bad. That which is Hungarian simply because it is Hungarian is not in itself right but can be either right or wrong. Therefore that which is foreign is not to be discarded purely on the basis that it is foreign, since it can either be disposable or acceptable. An old custom is not good simply because it is a custom nor is it something to be honored purely because it is old. It too can equally be either futile and immoral or sacred and wise.”

“Whatever we might say, all things progress through some form of borrowing and plagiarism, and everyone chooses a master, a role model, a prefiguration for him or herself even if not consciously.”

“The Romans imitated the Greeks, the French the Romans and the Greeks, the English the Greeks and the Spanish. – The Germans imitated all of them, and the nationality, however hidden it might have been, expressed to

⁶⁹ SZÉCHENYI István, *Világ* = SZEKFŰ Gyula, *A mai Széchenyi*, Bp., Révai, 1935, 188.

some extent characteristics borrowed from others. We Hungarians have imitated the Romans and not so long ago the French, now we are doing the same with the Germans. And thank the Heavens that our uniqueness has not yet reached its peak and that the time of our literature has not yet run out as had that of the Spanish and the Italians while the English, French and the Germans are perhaps past their prime, for life is still ahead of us and not something of the past.”⁷⁰

Herder⁷¹ who is considered to be one of the forerunners of nationalism alongside Rousseau (even though many of his contemporaries had no faith in progress and also refused to consider the preservation of culture purely for the sake of its uniqueness a virtue) also mentioned this as possible courses for progress. It is Herder’s “*instruction*” to first absorb all of that which your own people can provide, because then you will be able to appreciate that which is foreign and be better able to profit from it. Do not imitate the foreigner and do not reject him – says Herder.⁷² As a starting point we can thus establish that Széchenyi considered the already mentioned strong basis (consisting of the Aristocracy, national spirit and uniqueness, educated people and a strong economy) to be vital to even begin to talk about such a thing as a nation.

“Those who plant trees most probably know in advance how they could and will grow if the place where they planted the tree has previously been properly researched. In much the same way the growth, development and life-span of a nation can be somewhat predicted if we investigate with diligence its foundations and morals and the power of our souls grants us to comprehend these - or rather if in trying to understand them the timidness of our physical existence does not hinder the talents of our souls.”⁷³

Széchenyi also emphasised the moral dimension of existing as a nation. He believed that religion, more specifically Christianity, plays the important role of the essential moral basis for the existence of our nation. We must add here that Széchenyi inherited not only a vast estate and an aristocratic title from his ancestors but also a deeply rooted sense of religiousness:

⁷⁰ SZÉCHENYI István, *Hitel...*, i. m.

⁷¹ The philosopher who was well acquainted with the German and Eastern-European conditions created a theory which influenced not only the following 19th but also the national, nationality movements of the 20th century. It gave significance to culture based on the mother-tongue contrary to that of the suppressive ruling nation. He started the process he termed the awakening of the nation. The stations of which are the reformation of the language, the creation of a general national literary language and parallel to this, the creation of national theater, press and publishing.

⁷² *Eszmék a politikában...*, i. m., 65.

⁷³ SZÉCHENYI István, *Hitel...*, i. m.

“[B]ut before man can rise higher and his wealth begin to grow, before the virtues of the middle classes or those of living as a nation can take root, before indeed anything else, it is necessary for a nationality to exist. Without morals the nation shall collapse, whereas the existence of such virtues will help it rise. [...] And we will finally be convinced that the moral good, purified in the clear fountain of Christian faith is indeed today the base which promises the healthiest and longest life for the nation. And we will know that our home land will be happy when this kind of elevated national spirit is reviving our fields. To encourage ourselves to awaken such a spirit is our obligation just as it was the obligation of the cup-bearer of Darius to report each day with great discipline: King, forget not about the Greeks! – So too shall we remember our nationality.”⁷⁴

From the quotation it is also apparent what Széchenyi thought about the national spirit. He believed the national spirit facilitates the process of becoming a nation. This view is no different from the one expressed in the nation concept of Ernest Renan when he says that “the national spirit is an intellectual principle.”⁷⁵

Széchenyi’s concept did differ however with regards to the emphasis placed on the importance of religion. Although Renan did mention this aspect, he did not by far ascribe the same level of importance to it. According to Renan “the national borders are not determined by either language, location, religion or anything else”. This sentence points to the fact that the two concepts also clash in terms of the language aspect.

Given the problems of the age, and Széchenyi’s ambitions, we can establish that the themes defining the nation are all tightly interwoven and necessarily have to coexist. The moral aspect improves the possibility of financial gain, the economic aspect helps cultural development and all of these support political and national rejuvenation. Getting people to become interested in public affairs is the first step in shaking up the life of the nation. Improving the general financial state is essential for the development of the nation since a nation with a weak economy can never truly be free. The basis of a nation is therefore a shared past, which guarantees the unique qualities and spirit of the nation as a force for progress, morals, virtues and widespread education.

What else determines Széchenyi’s concept of the nation?

“A national language is the key part of any healthy nation, for while it exists, the nation shall live under any kind of treacherous circumstances for which there have been many examples. However, should it go numb one

⁷⁴

See id.

⁷⁵

Eszmék a politikában..., i. m., 190.

day, in our homeland nothing other shall grow but weeping willows whose branches sadly sweep the earth in memory of things past.”

“...But can a language flourish when the people do not? Language draws in the nation and carries it along.”⁷⁶

“And from the old to the young, from the rich to the poor, from the most outstanding men to the loveliest of our women, all should do what they can for our mother tongue. For with it we can achieve all that is the glory of not only the nation but the whole of mankind, while without it, we can achieve nothing.”⁷⁷

The quotations themselves prove the great importance Széchenyi attributed to the language of the individual national. In the Diet of 1825-27 he declared *“I have nothing to say here. I am not a member of the House of Delegates but I do own land and if there is such an institution which develops the Hungarian language, which helps our residents in their Hungarian education, I will offer it a whole years' funding provided by my estate.”⁷⁸*

„Because, if so, let us devote our last pennies without delay to the ‘masters of language’, in fact let us all become such masters ourselves ...”
“Let the whole World be able to converse in Hungarian and if that be the case one day, our kind shall be saved and glorified.”⁷⁹

“Oh dear, how few of us there are – so they moan – it is impossible to not melt in with the large numbers of Germans and Slavs. Language and nationality therefore must above all else be spread out.”⁸⁰

Széchenyi was working on the Hungarianisation of Pest, which would be the center of the yet to be established national culture. Herder's modern middle-class bourgeois national program also emphasized the importance of language. His national concept did not depend on state borders but on cultural unity, and culture is primarily transmitted and carried by language. In the case of the peoples where the transformation of the middle classes has not yet

⁷⁶ SZÉCHENYI István, *Napló* = SZEKFŰ Gyula, *A mai Széchenyi*, Bp., Révai, 1935.

⁷⁷ SZÉCHENYI István, *Világ* = SZEKFŰ Gyula, *A mai Széchenyi*, Bp., Révai, 1935, 220.

⁷⁸ The demand to expand the rights connected to the Hungarian language stem from the time of the Hungarian nation's awakening. The language program surpassed the order based framework of the period and the Conservatives along with the Court in Wien opposed it and supported Latin as the general language. The II. law of the 1844 Diet declared that from then on, in the territory of the Hungarian Kingdome instead of the previous Latin Hungarian would be the official language of legislation, administration, jurisdiction and education. The Hungarian became the state language brought to the surface tensions with other, none Hungarian nationalities.

⁷⁹ SZÉCHENYI István, *A Magyar Akadémia körül 1842* = SZEKFŰ Gyula, *A mai Széchenyi*, Bp., Révai, 1935, 324.

⁸⁰ See id. at. 328.

happened, the evolution of a sense of community is an important stage on the road to the birth of the nation concept.

“The nation can accomplish miracles. When one heart, one goal unites the residents, general freedom is born along with its countless glorious legions of niceties, charms and virtues. A few free souls can connect Mississippi with Columbia and should they wish to, they could evict the grand Niagara from its eternal bed. Something which millions of slaves could never have dreamt of, much less accomplished.”

The only possible form of this kind of conscious equality exists through the shared connection to a shared culture and history. Language, and the various art forms connected to it, are the vehicles of culture. Széchenyi confronted the Herder prophecy⁸¹; his nation concept did not consider the element of fear as something thematic. Instead he often emphasized the importance of experiencing collective success:

*“Had we but one outstanding relic which we could show our children and foreigners with the sweet sense of pride. How it would raise our souls if we had before us but one object to which we had contributed for many years with gentle and almost painful sacrifices.”*⁸²

We see that in Széchenyi’s opinion creating a nation is not purely a political task:

*“I am convinced that the secret to the advancement of the middle classes and development lies within the way we feel for the community.”*⁸³

How did Széchenyi define the nation?

I think my essay basically provides an answer to that question as far as that is at all possible using quotations, by examining the topic in a linguistic dimension based on statements made long ago, against the backdrop of the change language itself has undergone since.

Both in the Hungarian and international terminology we are faced with several problems when trying to describe such concepts as “nation” and “nationalism”. The difficulty can be best seen when we think about the impossibility of providing a moral sound translation for the Hungarian words such as “nép” (usually translated as people or folk) and “népies” (usually translated as folkish, vernacular)

⁸¹ Johann Gottfried Herder's predict (1791) One of his related predictions was that the Hungarian nation would disappear and become assimilated by surrounding Slavic peoples; this prophecy caused considerable uproar in Hungary and is widely cited to this day. „„Da sind sie jetzt unter Slawen, Deutschen, Wlachen, und andern Völkern der geringere Teil des Landeseinwohner, und nach Jahrhunderten wird man vielleicht ihre Sprache kaum finden.”

⁸² SZÉCHENYI István, *Hitel...*, i. m.

⁸³ *See id.*

Conclusion

In Széchenyi's case we are liable to idealize. By stripping them of the context of his life and the circumstances of his time we preserve his sentences in the form of maxims. By doing so, and ridding them of all flesh and blood we basically turn valuable observations into nothing more than empty phrases. In my essay I have tried to avoid doing this, and have tried to keep myself from reading any more or any less into what had been put on paper than what was actually meant, while examining the complete body of texts to analyze Széchenyi's use of the concept of the nation.

By reading his works it becomes evident that he considered it vital for the Hungarian nation to be able to stand its ground against the odds posed by its comparably small size and its unfavorable conditions. Today we can say that research into Hungarianness is once again booming. Scientific demand and international analogies both play a part in the emerging studies focusing on the question of what being Hungarian actually means. Related science is becoming a part of the public awareness. We must mention the appearance of foreign institutions such as Hungarian institutes, Hungarian faculties and departments dealing with the topic and the surge in their student numbers. This process coincided with and was also connected to the emergence of new cultural and foreign goals deriving from the transformation of historical Hungary, and the growing internal need for the definition of the Hungarian identity.

In the time that has passed since the collapse of Socialism and our joining the European Union the question of what being Hungarian actually means has reemerged and the need to reassess this topic has become not only timely but also an urgent task. This becomes apparent if we consider for example the political process related to the granting of dual citizenship. In this issue the concept of the nation played a central role, since it all came down to how the Hungarian State defines itself nationally. The debate focused on the kind of national ideologies we should consider as guidelines when approaching the question of Hungarians' living in neighboring countries or in other parts of the World, and whether the Hungarian state should become institutionalized according to a political-cultural or a national-cultural concept and what the legitimate concept of the nation should be.

Currently what we have to understand is that the answers given to all of the questions above are formed exclusively by political interests. However, even if the questions to be answered and the reemerging problems are in fact increasingly of a political nature, those great men among our ancestors can become important too, as they have the power to help us to address contemporary crises with the strength of their words which echo from the past.

References:

- Bibó, István: A kelet-európai kisállamok nyomorúsága. In: Bibó, István: Válogatott tanulmányok. Második kötet, 1945-1949., Magvető Könyvkiadó, Budapest, 1986.
- Borges, Jorge Luis válogatott művei II. (1999): Az örökkévalóság története Európa Könyvkiadó
- Bretter, Zoltán és Deák, Ágnes(szerk.) Eszmék a politikában: a nacionalizmus. Tanulmány Kiadó. Pécs, 1995
- Karl Marx és Friedrich Engels művei, (1981) 8.kötet, In.: Karl Marx és Friedrich Engels művei, Kossuth Kiadó
- Miskolczi, Ambrus: „Mi a magyar?” 7Századok, 132. évf. 1998. 6. sz.
- Nietzsche, Friedrich(1989): A történelem hasznáról és káráról. Akadémiai Kiadó
- Skinner, Quentin: Jelentés és megértés az eszmetörténetben In.: Horkay Hörcher Ferenc(szerk): A kora modernkori eszmetörténet Cambridge-i látképe. Tanulmány Kiadó, Pécs, 1997.
- Steiger, Kornél(1999): Lappangó örökség-fejezetek a prozokratikus filozófia antik hagyomásozásának történetéből József könyvek
- Szekfű, Gyula(1935): A mai Széchenyi Révai Nyomda Budapest
- Széchenyi, István (2002): Hitel. Budapest: Neumann Kht., forrás:<http://mek.niif.hu/06100/06132/html/index.htm> (downloaded: 20.12.2012)
- Széchenyi, István (2002): Stádium Budapest,Neumann Kht., forrás: <http://mek.niif.hu/06100/06135/html/index.htm> (downloaded:20.12. 2012)
- Széchenyi, István: A Magyar Akadémia körül 1842 In.: Szekfű Gyula(1935): A mai Széchenyi Révai Nyomda Budapest
- Szigethy, Gábor: Ezerkilencszázharminckilenc In: Babits Mihály A magyar jellemről Source: <http://www.neumann-haz.hu/scripts/webkat>

SYNCHRONOUS COMMUNICATION BETWEEN HIGHER EDUCATION INSTITUTIONS AND EMPLOYERS IN THE FIELD OF SOCIAL WORK

Prof. PhDr. Beata Krahulcová, PhD

Charles University in Prague, Department of Psychosocial Sciences and
Ethics, Social Work, Czech republic

Ass. Prof. Dr. Olga Zelinkova, PhD

Charles University in Prague

Abstract

Typical of post-communist and post-industrial development of society in Central Europe is inter alia the inability of a significant part of the population to keep pace with the global societal requirements. The statistical data of social security offices indicate that the disintegrated persons or persons at risk of disintegration represent about one third of the population. The complexity of the phenomenon and the size of social demand for professions dealing with it trigger the process of training for professional qualification of social workers and the competition between quantitative and qualitative requirements for vocational training and its standardisation. From the perspective of both the educators and employers, it is necessary to assess the importance of theoretical training and experiential learning of future social workers and also the employability of young graduates from social work study programmes in the labour market.

Keywords: Employability of young graduates, employability factors, labour market

Contextual factors

Matters related to the employability of graduates from bachelor's degree programmes and follow-up master's degree programmes in the field of social work in the labour market rank among the often discussed and closely watched topics by the society. The growing societal need for qualified workers brings about the high demand for studies among young candidates as well as (in lifelong learning - LLL) persons lacking any useful qualification or persons at risk of unemployment. Essential for employability of graduates in the labour market is their choice of a particular study programme (oriented at social and health topics, social and theology topics,

or at social work focusing on social policy, or at a related field of study of development and humanitarian work), and also the environmental factors influencing the employability of the graduate in his place of residence, the level of his qualification (tertiary vocational school, bachelor or master degree). From the educators' perspective, also important is the **contact between the student and the potential employers already in the course of his studies, his practical experience and/or also the quality of personal portfolio defended at the state examination?? in social work, such as the preparation for selection procedures in order to get a job.**

- **Social work represents a regulated profession and activities** (in accordance with Directive No. 2005/36/EC)

- **Minimum standards of training for professional qualification** for the fields of study, basis for accreditation of educators, minimum standards for practice and supervision – study outputs are defined, learning journey fully respects the processes of experiential learning, evaluation of outputs from practise is changing

- **Multilayer linkage between theory and practice** in the course of training for professional qualification of social workers – methods of implementation of requirements raised by social practice and development of the field, development of www.nsk.cz vocational qualification (specialisation) of social care/ social work

- **Contact between the student and potential employers** as early as during the study, his practical experience and/or also the quality of portfolio defended at the state social work examination as a preparation for the process of vocational qualification (National Register of Qualifications - NRQ), as a basis for employability in the labour market for getting and retaining a job, for the sake of education for the future

Minimum standards of training for professional qualification quite clearly define the content parameters of the study, which are identical across the educational programmes in the Czech Republic and in the EU Member States and represent the key prerequisite for accreditability of the fields of study. This has been fully confirmed also in interaction with partners under several projects in Scotland, Poland and Slovakia.

Methods

In spite of high societal demand, a certain number of graduates from social care/social work study programmes **fails to find a job, namely 2.7 %** (the data stated by the Charles University - Education Policy Centre for 2014), and additional **unspecified number of graduates fails to find a job matching their level of qualification** or they get a job outside their profession.

The development of social work theory and practice, diversification of labour market needs in this area call for:

- **Synchronised communication between educators and employers,**
- Persistent efforts to **update the technical content of taught subjects,**
- **Quality supervision and mentoring of a high volume of field experience in social work** – approximately 25 - 35 % (tertiary vocational school, bachelor or follow-up master degree) of the volume of practical training in the field
- Last but not least, educating the mentors and offering them training courses within the system of **lifelong learning** – **or in the form of the so called social clinics.**

Partnership as a factor increasing the chances of graduates to get employed in the labour market in the area of social work. A number of projects is being developed both by schools and employers to support the partnership between schools and employers. The educators, however, have to make do with a limited number of suitable partners in the commercial sphere, whereas the companies on the other hand prefer to target their recruitment activities at a fairly narrow segment of the fields.

For educators in the field of social care the following is proved to be crucial

- To create the **Portal of systematized practice,**
- Necessity to **synchronise communication with employers,**
- To exert consistent efforts in order **to update the technical content of taught subjects,**
- To perform **quality supervision and mentoring of a high volume of field experience in social work.**

In this context it appears necessary, due to high degree of diversification of work positions and client groups in social practice, to focus on **modelling of career pathways of graduates in the field of social care,** namely already **in the course of the study, to guide the students through self-experiential training and subsequently through higher-education counselling support oriented at career counselling.**

Building bridges between theory and practice. Cooperation in projects. Safe labour mobility. Anticipated consequences of application of the drafted Act on social workers and professional chamber. To initiate projects coordinated at the national level, such as the Continuing Education Fund project called "Placements at Companies – Learning through Practice" ("Stáže ve firmách – vzdělávání praxí"), to support its sustainability. Unfortunately, its funding by the European Social Fund often leads to a time-limited or purposeful involvement also of those companies which do not really consider the balanced partnership with students and

especially the subsequent use of their work. Therefore, also the unique project **Meet the Companies (Seznamka s firmami)** shall be mentioned, implemented by the Ingenio et Arti accredited education centre. The principle of the “dating agency“ is more important than the immediate economic impact, namely that no branch is unattractive and no company too small. The project does not primarily seek to place the interns, but rather to establish a partnership between the student and the company that can be initiated through the commonly defined topic of the thesis or through the project defended at the state examination. The Meet the Companies project was recently officially released on www.bakalarkavpraxi.cz. In order to achieve its purpose, a representative sample of students shall be collected within a reasonably short period of time who are interested in elaborating the bachelor's or master's thesis for a specific company partner.

Another, highly appreciated form of cooperation between the educators and employers are job fairs, career preparation of students and young graduates by the respective practitioners, presentation of career information.

Results

Below you will find some of the results of the probe into conditions, process and efficiency of employability of graduates from bachelor (National Register of Occupations 6) and master (National Register of Occupations 7) Social work study programmes, and opinions of graduates, educator and employers:

The survey of the process of preparation (training), preparedness and employability of graduates from social work study programmes as perceived by them, by the educators and by the employers was conducted in the period from January to December 2014 among the total of 120 students of the Charles University, among the total of 20 contracted registered providers of student's practical training and placements (the data was collected during the Job Fair in the field of social work, held at the Charles University), among the academia providing education in the “Social and charity work” field of study (The Hussite Theological Faculty of the Charles University, The Protestant Theological Faculty of the Charles University, The Faculty of Arts of the Charles University, in total among 20 members of academia). Altogether 160 respondents have been approached and the survey and assessment of results were done by the author of the probe and the paper.

NRQ/7 Opinion on one's own competences to perform the specialisation of a social worker in accordance with the drafted Act on social workers and professional chamber and with the National Register of Qualifications

Self-reflection of the graduates from social work study programmes:
liaison officer in social services - specialist, advisor in social services - specialist, resocialisation worker - specialist, social worker - specialist.

- To what extent do I understand (4) the professional specialisation/qualification (on a scale of 1-5)
- To what extent do I feel professionally prepared by school and practice (3.5)
- To what extent does the social practice need specialisation – employability of respective specialisation/qualification (3.5)

Advisor in social services - specialist

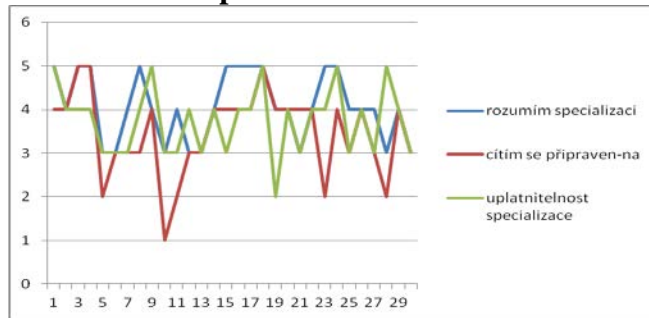

The response to question concerning the understanding of specialisation/qualification was 4 on average, and the response to both the questions whether I feel prepared and the question concerning the employability of the specialisation/qualification was 3.5

Performance of specialised liaison activities

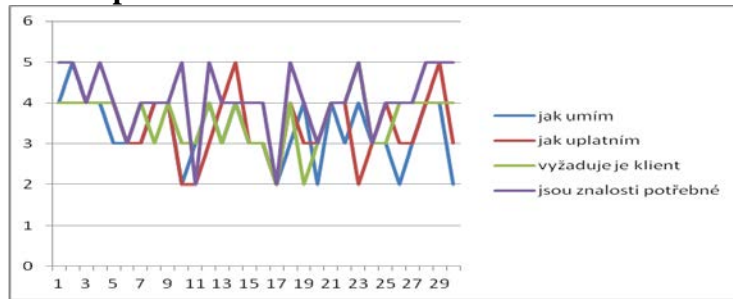

The respondents gave the following answers to the question regarding the **expert knowledge**: What is my knowledge (coefficient 3), To what extent do I use the knowledge (coefficient 3.5), What knowledge is required by the client group (3.5), To what extent is my knowledge necessary and compatible with the structure of provided social services (4)

Resocialisation processes and social therapy

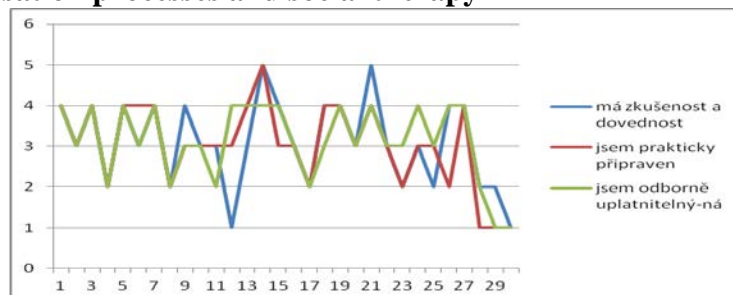

Assessment of **expert skills**: I have the experience and the skills to provide independently resocialisation and social therapy (coefficient 3), I have practical knowledge to establish contacts, to investigate, to provide counselling and to represent (3), I am employable as a professional in the social and legal area, in state administration and local government (3) **(continuous process of legislative amendments)**

A probe into the conditions, process and efficiency of employability of graduates from bachelor Social work study programmes (NRO 6), opinions of graduates, educators and employers

Employers presented their opinion on expert knowledge of young graduates – the aim was to map their opinion on expertise, skills and competences of graduates from social care study programmes:

- The graduate is familiar with the rules, legislation, procedures...
- The graduate has theoretical knowledge to perform social work in individual areas of social care...
- The graduate is employable as a professional in the social field.

The respondents were asked to circle one of the answers on the scale: 1 definitely not/ 2 rather not/ 3 I do not know / 4 rather yes/ 5 definitely yes

Procedures for identifying citizens in unfavourable social situation, analyses of their needs, and the ways of acting in respective communities

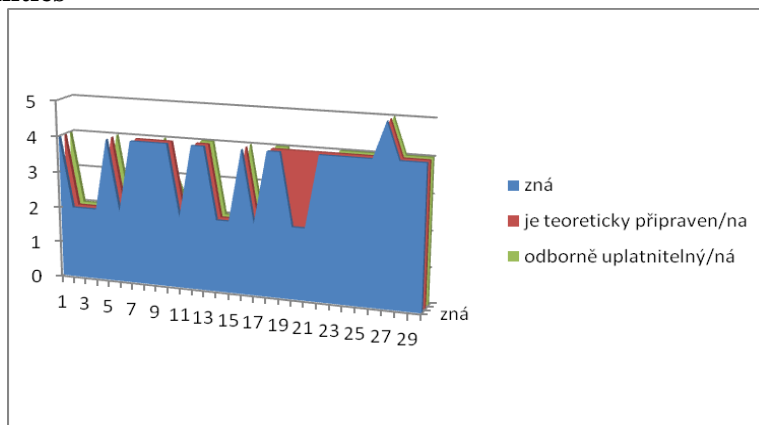

The interviewed employers of young graduates responded as follows: The graduate is familiar – average coefficient 3.4, The graduate has theoretical knowledge - 3.5, The graduate is employable as a professional - 3.2

Minor shortcomings in teaching concerning certain practical experience, skills, way of thinking

Kolb's experiential learning cycle during the placement – (1)

Concrete experience – own activity, the student visits the client, **the student is feeling**,

(2) Reflective observation – the mentor discusses the experience of the student or the student himself reflects the course of the visit, where he succeeded and where he failed, **the student is watching**, (3) Abstract conceptualisation – drawing general conclusions, based on the experience with the visit the student makes general conclusions, he links the concrete experience with the theory, he lays foundations for the next visit, which procedures would be fitting or which would not be fitting, he develops a plan of changes to be tested in the next activity, **the student is thinking**,

(4) Active experimentation – the student develops and tests the new plan for a visit at the client, he tries new alternative procedures during the visit, which constitutes a starting point for new concrete experience and the whole cycle starts again – **the student is doing**.

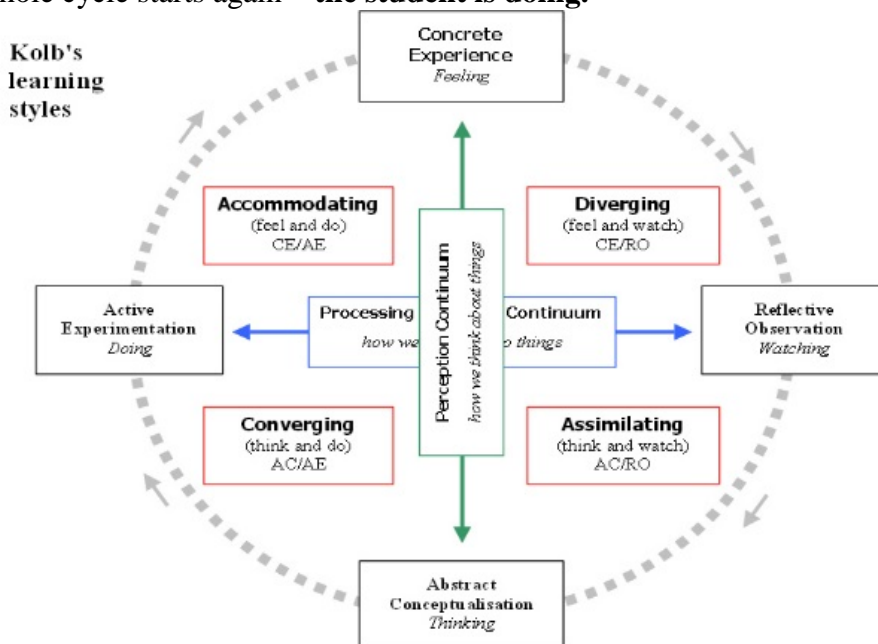

© concept david kolb, adaptation and design alan chapman 2005/06, based on Kolb's learning styles, 1984
Not to be sold or published. More free online training resources see at www.businessballs.com. Sole risk with use.

Experiential learning is effective if all 4 methods of learning are gradually used in the process of learning. The student can start at any stage, but the sequence of stages shall be observed. It is not the mentor, but the student who arrives at conclusions and draws general conclusions. The assessment was done with the use of the Kolb's learning styles inventory.

Conclusion

- To provide **comprehensive knowledge and skills** in social care fields of study
- To strengthen the positive impacts of structured and consistently applied practice – the principle that **the students are learning what they are doing** (to encourage experimental learning, common learning, hierarchical learning)
- To create other ways of education which enable the students to apply in practice what they learn
- To focus on **innovating the ways of assessment** and on verifying whether the applied knowledge and skills of students correspond with the target learning outputs defined in accredited fields of study and subjects
- To improve the level of acquired knowledge and skills of students, and thus also the **quality and competitiveness of graduates**

Social work has had a long tradition. Social work of some form has been present throughout the history of mankind, but as a branch of human activity, a field of study and a regulated profession it has markedly shifted from its charity forms prevailing in 1800s to the current concept of an expert worker, through gradual **standardisation of social services and their establishment in the social order**.

A social worker is a professional who avails of the relevant knowledge and responds in his work to the actual situation of the persons, his clients. Day by day he works with the consequences of poverty, diverse social dysfunctions, consequences of social disintegration of persons. In order for him to be able to work effectively, the educators shall very **precisely determine the volume and level of theoretical training and controlled and supervised acquisition of experience from social practice**. In spite of that **the lifelong learning of social workers** is crucial, namely for the sake of their long-term employability in the labour market.

Moreover, if top quality social work is to be delivered, it will be necessary to **support the professional status** of social workers in every possible way and the generally improve the social prestige of the area of social work. Social workers nowadays face strong dilemmas they have never faced before in Central Europe.

References:

KRAHULCOVA Beata. *Communication systems of hearing impaired persons*. Prague: BEAKRA, 2014. ISBN 978-80-903863-2-7.

KRAHULCOVA Beata. *Open the door to the labor market in the field of social services*. European project. Human Resources and Employment. Reg. N. CZ.1.04./5.1.01/77.00294 . Charles University in Prague and Civil Advice. 2012 – 2014.

IMPLEMENTING A SUSTAINABLE PURCHASING POLICY: AN EXPLORATORY STUDY IN THE COLAS GROUP

Oihab Allal-Chérif, PhD

Head of Operations Management and Information Systems Department
Kedge Business School, Talence, France

Abstract

This article addresses the contribution of the purchasing function to Corporate Social Responsibility (CSR). Indeed, the purchasing function is playing an increasingly important role in businesses, averaging over 60% of turnover. Simultaneously, managers integrate societal and environmental challenges in the management of internal and external relations. Sustainable purchasing policies, aimed at changing practices throughout the value chain, are deployed. Suppliers are therefore gradually mobilized to implement more responsible practices, and invited to commit themselves through sustainability charters and certification. That leads to the research question: how to implement a sustainable purchasing policy aligned with the corporate strategy? The CSR approach represents a particularly difficult challenge for some companies, as in the construction and civil engineering sector. The Colas Group, world leader in road construction, faces this difficulty that implies radical changes in its relations with its suppliers. Faced with the image of environmental pollution, landscape destruction, illegal labor, and endangerment of its workers, the Colas Group has implemented a progressive, rigorous and structured sustainable approach. Through participatory action research during a one year immersion, a case study of the Colas Group has been developed to analyze this approach and determine its benefits and limits. The particularly difficult context of the implementation of this sustainable purchasing policy – in a multinational, in a post-merger period, in an unfavorable sector and during an economic crisis – implies potential transferability of some practices studied in this specific case.

Keywords Purchasing, Sustainable, Suppliers, Case study, Colas Construction

Introduction

Sustainability is a major issue for all businesses of all sizes and from all sectors. It is of even greater importance in the industry, where the purchasing function represents often more than 80% of the turnover. This function plays a key role in how the Corporate Social Responsibility (CSR) of a company will be implemented and perpetuated (Crespin-Mazet & Dontenwill, 2012).

For a company to be sustainable, it's not sufficient to control all intern processes and to respect social, ecological and economical principles within its frontiers. It has to take into account all its suppliers, and its suppliers' suppliers, and to make sure they follow the same model: "Each organization is only as sustainable as its upstream supply chain" (Schneider & Wallenburg, 2012). Buyers therefore should ensure that suppliers pursue an industrial policy that is compatible with their sustainable principles and share the same culture. Strategic objectives should be determined jointly (Sytch & Gulati, 2008). Beyond cost killing, sustainable buyers favor suppliers with whom they can establish long-term partnerships. After a period during which purchasing frantically sought to cut costs and rationalize processes, it now concentrates on efforts such as technological advancement, innovation, sustainability, and global B2B marketing (Ortas, Moneva, & Álvarez, 2014).

The purpose of this article is to characterize the benefits and limits associated with the implementation of a sustainable purchasing policy and to provide a thorough analysis of a complex case. A focus is made on suppliers' implication in the process of developing a socially and environmentally responsible supply chain. The chosen company is the Colas Group, world leader in road construction, whose brand image is hardly compatible with sustainability due to its activities. Following this introduction, the next two sections review the literature linking purchasing to corporate social responsibility. A section is then dedicated to present the exploratory case study methodology. The last two sections present, analyze and discuss the Colas Group case and the way a sustainable purchasing policy aligned with the corporate strategy was implemented. A conclusion summarizes the contributions of this article.

Aligning the purchasing strategy with the corporate sustainable policy

As defined by the European Commission, Corporate Social Responsibility is "the voluntary integration by companies of social and ecological issues in their business operations and relationships with all internal and external stakeholders, in order to fully meet the applicable legal obligations, invest in human capital, and respect the environment" (European Commission, 2001).

As a societal actor, a firm cannot be only preoccupied by its sole wellbeing: it should be involved in the wellbeing of the whole society (Franklin-Johnson & Richomme-Huet, 2012). In 2002, when he was Secretary-General of the United Nations, Kofi Annan said: "Without the private sector, sustainable development will remain only a distant dream. We now understand that both business and society stand to benefit from working together. And more and more we are realizing that it is only by mobilizing the corporate sector that we can make significant progress. The corporate sector has the finances, the technology and the management to make all this happen. The corporate sector need not wait for governments to take decisions for them to take initiatives" (Colbert, Kurucz, & Wheeler, 2012). Although more and more standards appear, this collective responsibility and the moral conscience of the companies are voluntary and are inextricably linked with corporate image and economic profitability.

The involvement of the purchasing function in the corporate CSR policy increases both with the company's size and with the level of maturity of CSR. Sustainable purchasing is exposed to two types of risks: on one hand the risks associated with the products bought that may pollute, be non-recyclable or unsafe; on the other the risk of the supplier that may employ children, destroy natural resources (Fel, 2011). To remedy this, the purchasing function integrates sustainable principles and follows the corporate CSR policy throughout the purchasing process: from the definition of need in which eco-design can be promoted, to the preparation of the requests for information, for proposal, for quotation, or for tender in which buyers can introduce societal constraints, through the weighting of sustainable development criteria in the bids received (Fel, 2011).

Any company that claims to be sustainable must also work with responsible suppliers (Schneider & Wallenburg, 2012). To ensure the compatibility of its strategy with those of its suppliers, the company will have to identify social environmental and economical standards its suppliers must meet. The sustainable performance of its current suppliers should be evaluated, objectives should be set according to future needs, and the complete purchasing process must be redesigned according to CSR requirements (Dai & Blackhurst, 2012). Sustainable procurement imposes constraints on suppliers: they must be able to bring high economic value with competitive costs, to respect high environmental standards, and finally to contribute to strengthening the social values of the company (Ageron & Spalanzani, 2010).

Factors facilitating and inhibiting the implementation of a sustainable purchasing function

The most important motivation to implement a sustainable procurement policy is to improve the image of the company among its stakeholders, especially its customers. Sustainable development remains generally a marketing effort to convey a positive image. Other motivations are compliance with regulations and willingness to behave responsibly. However, neither search for competitive advantages nor cost reduction are recognized as major motivations (Ageron & Spallanzani, 2010). While motivating factors vary from one company to another, the two main factors in favor of sustainable purchasing are top management's initiatives and government regulations (Giunipero, Hooker, & Denslow, 2012).

Financial constraints associated with sustainable procurement are the main obstacles to their implementation. The necessary investments may not be profitable (Schneider & Wallenburg, 2012). Sustainable products are often perceived as more expensive as regular ones. Assessing the sustainability of suppliers and auditing them regularly to verify that they comply with CSR principles has an elevated cost that is not easy to assume in times of crisis (Ageron & Spallanzani, 2010).

A contradiction can therefore be found in the guidelines for managers. On the one hand they say that financial constraints have very little impact on the sustainable development strategy, on the other hand they require substantial cost reduction in crisis period. The short- and long-term goals seem therefore completely incompatible (.

Action research in an exploratory and prospective approach

The objective of this research is to observe how an industrial company implements a sustainable purchasing policy and to understand the issues involved. For this, we designed a thorough case study of the Colas Group. From this case study, a number of analysis parameters will be identified and good practices will be analyzed. Yin (1984) explained that the number of cases was not a validity criterion of the method: it is not necessary to have a multitude of cases to identify the relevant parameters of analysis. This is less the number of cases than the methodological rigor of the construction of these cases which is decisive in the description, understanding and explanation of certain phenomena. Using multiple cases allows only reinforce the results already achieved with one.

The choice of Colas Group is due to the fact that this company is a world leader in road and rail track construction. These activities are often associated with landscape destruction and environmental pollution (Murray & Dainty, 2013). This is why it's essential for Colas to improve its sustainable strategy and initiatives and to promote them to its clients and to the public in order to modify the perception they have and to improve the brand image. "In general, the case studies are the preferred strategy when the

questions' how 'or' why 'arise when the researcher has little control over events and when the focus is on a contemporary phenomenon in a real life context" (Yin, 1984, 2011). That is the case here of sustainable purchasing strategies, a recent approach that is implemented only in large groups where the maturity of the purchasing function is very high.

Empirical research was conducted for one year as part of an exploratory action research based on participant observation (Hatchuel & Molet, 1986). The constructivist approach focuses specifically on social interactions and processes as explanatory patterns of reality (Berger & Luckmann, 1966). The principle of "Generating theory" (Glaser & Strauss, 1967) or "building theory" (Eisenhardt, 1989) will be applied to the sustainable purchasing concept observed in the Colas Group. Grounded theory generates new theories in human and social sciences through immersion in the empirical data of existing theories regarding the observed phenomenon here sustainable purchasing. These new theories complete existing theories and explain new situations (Glaser & Strauss, 1967). Data collection has used simultaneously a wide range of complementary techniques: individual interviews, group interviews, participation in workshops, brainstorming sessions and think tanks (Miles & Huberman, 2003). The literature review was carried out gradually throughout participant observation, after an initial intensive documentation. Then, to highlight, complete and analyze the theoretical framework that has been set, interviews were conducted with two purchasing managers from the South-West of France Colas Group Agency.

The sustainable strategy of the Group Colas

Colas Group is a world leader in road construction and maintenance. The company Colas has also positioned itself as a major player in rail tracks construction and maintenance, pipeline facilities, as well as in the marketing of oils, waxes, paraffin and other refined products. This subsidiary of the Bouygues Group, which employs more than 60,000 people, is involved each year in more than 100,000 sites in 50 countries on 5 continents. Colas achieved a turnover of 12.4 billion euros in 2014, of which 47% outside of France, for a net profit of 604 million euros.

The Colas Road Company was born in 1929, following the invention of the first form of bitumen emulsion by two British researchers in 1920, the COLd ASphalt, and the acquisition of a patent by the French Alexandre Giros. Colas develops both through organic growth by establishing itself gradually in several regions, and mainly through external growth by acquiring other companies on several continents, like Sintra in 1964. Then Colas is itself acquired by the Group Bouygues in 1986. It will absorb Sacer in 1992 and Screg in 2012.

Today, the activities of Colas are diversified to include a Rail Division launched in 2000 and that achieves a turnover of 904 million euros in 2014, up 18%. The company continues to expand internationally by acquiring new entities like in Denmark or Australia. With an order book of 7 billion euros to start the year 2015, the company continues to increase slightly overall, though its turnover stagnated. In 2014, Colas rehabilitated roads in Ohio and Pennsylvania, built a seaside promenade in Los Angeles, renovated a bridge in Bangkok, supplied 100.000 tons of mix for the Jakarta beltway, built a subway extension in Kuala Lumpur, extended the airport runways in New Caledonia and enabled the extension of motorway and tram in Budapest.

The 60.000 Colas employees are spread within 800 business units and 2.000 production units worldwide. The human resources management of Colas bases its policy on two principles: the human dimension and well done work promotion. These two principles are available in six core values: (1) sense of the initiative: every employee is an "entrepreneur" animated by the desire for conquest, commitment and success; (2) responsibility: everyone takes responsibility for his decisions and actions; (3) confidence in the group: relationships based on trust, honesty and authenticity; (4) respect: the basic behavior of every employee in all actions, self-respect, respect for other employees, customers, third parties, social partners, society in general, the group's principles, laws and regulations, the environment, equity and ethics in the broadest sense; (5) setting an example: giving the best of oneself, constantly seeking quality, demonstrating professionalism are a daily requirement for each employee; (6) humility: questioning yourself and staying humble allow each employee to always progress.

The area of construction and civil engineering is particularly concerned with the issues of corporate social responsibility. Indeed, the sites where Colas is involved generate significant impacts on the environment, energy consumption, workers and users' safety, territories and equipment' accessibility, and residents' well-being. The main issues identified by Colas' managers and which should be taken into account by buyers are: (1) prevention of risks and professional illnesses of employees and especially of workers who are in the field; (2) hygiene, safety and training of all staff; (3) management of jobs and careers; (4) vocational integration and reintegration into the labor market; (5) valorization of diversity and social and cultural mix; (6) fight against illegal work, corruption and conflict of interest; (7) reduction of greenhouse gas emissions and research of high environmental quality; (8) energy savings and fight against global warming; (9) use of sustainable materials without negatively impacting future resources; (10) recovery and reprocessing of waste; (11) limitation of visual and noise pollution (12) preservation of natural areas and landscape integration; (13)

preservation of biodiversity; (14) territorial anchorage and proximity with local actors; (15) mobility and the opening up of territories.

These priorities don't only correspond to societal and environmental concerns, but they also reflect important business issues. On the corporate website, one can read that "the sustainable development strategy of Colas aims to design, build and operate sustainable structures while taking into account the aspirations of its stakeholders: customers, partners, employees and civil society. Colas Group provides solutions that reduce environmental impacts while seeking to improve the living environment of users. This approach developed at all stages of projects, from design to operations, is gradually spreading throughout cities and countries".

The company's annual report also highlights that Colas is pursuing a profitable growth strategy that integrates a responsible development approach, with social, societal and environmental dimensions, and that aims to meet the needs of today's world in terms of mobility, urbanization and respect of the environment. The company's strategic priorities are: strengthening and extending the network of permanent offices worldwide, controlling materials and resources required for activities, pursuing the development of specialized activities, offering expanded and innovative services, developing new products and techniques, focusing on profitability instead of volumes.

Performance indicators have been defined to assess the level of achievement in each area, as well as the evolution of these achievements. They are grouped into four categories: authenticity, simplicity, reliability and cross. These indicators are quite diverse and include: the quality certification level, volumes and rates of recycled or recyclable materials, the carbon footprint, the accident rate, the followed training time, ratios juniors/seniors and men/women, the number of people reintegrated into the labor market, and the average duration of contracts with suppliers.

The implementation of a sustainable purchasing policy in the Colas Group

Colas's Purchasing Management is part of the Procurement and CSR Committee of the group. This favors the progressive integration of CSR principles into the actions, decisions and processes of the purchasing function. This committee aims to integrate all actors of the value chain into the sustainable initiative, especially suppliers, subcontractors and service providers. This approach integrates the different stages of the relationship: upstream, using mapping and risk analysis, when selecting suppliers through the inclusion of CSR criteria for products and services; at the stage of contracting through the inclusion of a CSR charter; and finally, during the execution of the contract with assessments of supplier CSR performance and

occasional audits. The sustainable purchasing policy is adopted in 2014 and will disseminate its principles in all areas of the company, and in all international agencies.

The very large number of suppliers involves having a progressive and targeted approach, starting with the most critical suppliers. Purchases being completely decentralized in different locations and even in different construction sites, it is particularly difficult to change the habits of employees in charge, even more homogeneously. Moreover, the merger of Colas with Screg in October 2012 led to a major restructuring that has strongly impacted all services, including the still emerging procurement function. Indeed, this function has a low level of maturity and is still closer to basic procurement than to a real supplier relationship management.

For the managers of Colas, doubling the number of agencies following the merger is an opportunity to implement rigorous procurement processes and to introduce new more responsible and sustainable practices. It is also the ideal occasion to communicate with suppliers to raise awareness of the new CSR vision. An initiative is launched to centralize relations and negotiations with strategic suppliers at headquarters of each region for a more homogeneous communication and to have more impact.

The purchasing function was not easily accepted when operators had to transfer to them some of their activities, such as negotiation which constituted an important part of their job. However, the bargaining power of buyers, who represent a region, that is to say often more than fifty agencies, is much more important than the one of local operators. It is an opportunity to realize savings on grouped volumes that are inaccessible to each agency separately. Buyers can also have much higher requirements in terms of compliance with deadlines, standards and other contractual terms given the amounts involved. The development of the purchasing function in each region depends on the commitment and support of agencies and thus on how purchases will demonstrate their performance and added value.

The purchasing function endeavors to show its expertise as a support function for the agencies by conducting consultations and offering very competitive bundles. It seeks to be as flexible, versatile and efficient as possible not to disappoint the operators. To benefit from the best deals, there must be enough voluntary agencies accepting to delegate their sourcing to reach a critical level. Regional procurement services may also offer to reference new more competitive suppliers, with a higher quality level, with wider product lines or with a more responsible corporate culture. The purchasing department makes suggestions, but it also responds to requests from agencies facing increased competition. Framework contracts of one to three years are established across each region, to benefit from adjusted prices

and year-end rebates based on volume commitments and to establish privileged partnership relations with some suppliers.

The pressure is very strong, particularly on the costs that remain the main decision criterion. In the construction and civil engineering sector, it's essential to respect the deadlines because sponsors have significant time constraints and may charge penalties if the deliverables are not completed on time. The quality is governed by extremely strict standards, and the failure to comply can also have catastrophic consequences, both financially and on the reputation of Colas Group which claims the excellence of its practices. Given all existing constraints associated with costs deadlines, and quality, it is particularly difficult to sensitize stakeholders and operators to CSR.

The Colas Group created a Responsible Purchasing Committee, in which decentralized buyers of various regions meet regularly. This entity pools the knowledge and good practices to disseminate them and to implement action plans on topics such as waste reduction, carbon footprint, recycling, packaging, personal protection or working conditions. This committee has deployed the EcoVadis rating methodology. This agency provides measurement methods and performance criteria to limit risks and evaluate opportunities related to responsible purchasing. The EcoVadis solutions provide centralized dashboards with indicators to measure the results achieved by the action plans launched by the purchasing function with a particular emphasis on innovation and CSR.

Since 2009, according to the recommendations of this Responsible Purchasing Committee, Colas requires that for each framework contract set up with a supplier, the group's CSR charter will be attached. It focuses on four aspects of the Group's CSR policy: (1) ethics; (2) compliance with labor standards; (3) protection of health and safety; (4) protection of the environment. This charter stipulates that in case of a serious failure of a supplier to comply with one of these principles, sanctions will be taken, up to termination of the contract without compensation in damages.

Many meetings and training sessions were held with buyers to transmit them information and guidelines about the institutional CSR policy. However, due to limited resources, audits are restricted to strategic purchasing families and it is particularly difficult to have visibility on the entire purchasing portfolio. Therefore, to verify the compliance of all suppliers to all the principles of the CSR charter seems illusory. The challenge is to find solutions to improve the CSR commitment of suppliers and better measure their progress. To this end, the purchasing function launched a consultation of suppliers to determine their vision, their willingness to progress, and to establish a coaching process towards continuous improvement focused on social and environmental responsibility.

The purchasing function then categorized suppliers based on their responses and negotiated means to be able to support the most committed ones.

Conclusion

After a literature review to present the necessary alignment between the CSR corporate strategy and the purchasing management, and the benefits and limits of a sustainable purchasing policy, this paper provides an in depth case study of how a multinational company can implement a sustainable purchasing policy and involve its suppliers in its CSR strategy. It's difficult to promote the values associated with CSR into the company, but it's even more difficult outside of it. Convincing suppliers and partners to comply with new constraints and to change their culture and practices is a slow and progressive process. Cost optimization efforts may seem in conflict with the practices of sustainable development, and managers do not seem able to combine both.

To improve its image and to comply with the new requirements associated with its activities, The Colas Group has set up a rigorous and ambitious approach to improve the performance indicators associated with sustainable procurement. However, this ambition has been hampered by lack of resources, the context of a merger, the strong decentralization of purchasing and economic crisis. This example can be an inspiration for managers who wish to implement a sustainable procurement policy, both for drawing on methods used in the Colas group and to become aware of the obstacles they may encounter.

References:

- Ageron B., Spalanzani A. (2010). Perceptions et réalités du développement durable dans les entreprises françaises : Le point de vue de l'acheteur. *Revue française de gestion*, 6(205), 157-171.
- Berger, P. L., & Luckmann, T. (1966). *The social construction of reality: A treatise in the sociology of knowledge*, Anchor.
- Carroll, A., & Buchholtz, A. (2014). *Business and society: Ethics, sustainability, and stakeholder management*. Cengage Learning.
- Colbert, B., Kurucz, E., & Wheeler, D. (2012). Building the sustainable organization through adaptive, creative coherence in the HR system. In Burke, R. J., & Cooper, C. L. (Eds), *Building More Effective Organizations*, 310-333.
- Crespin-Mazet, F., & Dontenwill, E. (2012). Sustainable procurement: Building legitimacy in the supply network. *Journal of Purchasing and Supply Management*, 18(4), 207-217.

- Dai, J., & Blackhurst, J. (2012). A four-phase AHP–QFD approach for supplier assessment: a sustainability perspective. *International Journal of Production Research*, 50(19), 5474-5490.
- Eisenhardt, K. M. (1989). Building Theories from Case Study Research, *Academy of Management Review*, 14(1), 532-550.
- European Commission (2001). *Green Paper: Promoting a European Framework for Corporate Social Responsibility*.
- Fel F. (2011). Maturité des démarches RSE et achats durables. *Revue Sciences de Gestion*, (84), 83-100.
- Ferri, L. M., Oelze, N., Habisch, A., & Molteni, M. (2014). Implementation of responsible Procurement Management: An Institutional Perspective. *Business Strategy and the Environment*, 24(5),
- Franklin-Johnson, E., & Richomme-Huet, K. (2012). Crise et gestion de la responsabilité sociétale des entreprises du CAC 40: Analyse de leur communication sur leur politique RSE entre 2006 et 2010. *La Revue des Sciences de Gestion*, 255(3), 75-83.
- Giunipero, L. C., Hooker, R. E., & Denslow, D. (2012). Purchasing and supply management sustainability: Drivers and barriers. *Journal of Purchasing and Supply Management*, 18(4), 258-269.
- Handfield, R., Sroufe, R., & Walton, S. (2005). Integrating environmental management and supply chain strategies. *Business Strategy and the Environment*, 14(1), 1-19.
- Glaser, B., & Strauss, A. (1967). *The Discovery of Grounded Theory: Strategies for Quantitative Research*. Wiedenfield and Nicholson.
- Hatchuel, A., & Molet, H. (1986). Rational Modelling in Understanding Human Decision Making: about two case studies. *European Journal of Operations Research*, 24(1), 178-186.
- Murray, M., & Dainty, A. (2013). *Corporate social responsibility in the construction industry*. Routledge.
- Ortas, E., Moneva, J., & Álvarez, I. (2014). Sustainable supply chain and company performance: a global examination. *Supply Chain Management: An International Journal*, 19(3), 332-350.
- Quairel, F., & Capron, M. (2013). Le couplage «responsabilité sociale des entreprises» et «développement durable»: mise en perspective, enjeux et limites. *Revue française de socio-Economie*, 11(1), 125-144.
- Schneider, L., & Wallenburg, C. M. (2012). Implementing sustainable sourcing—Does purchasing need to change?. *Journal of Purchasing and Supply Management*, 18(4), 243-257.
- Yin R. K. (1984). *Case Study Research: Design and Methods*, Sage.
- Yin R. K. (2011). *Applications of Case Study Research*. Sage.

FASHION: MALAYSIAN MUSLIM WOMEN PERSPECTIVE

Muhammad Tahir Jan, Assistant Professor

Kalthom Abdullah, Associate Professor

Department of Business Administration,
Faculty of Economics and Management Sciences,
International Islamic University Malaysia, Kuala Lumpur, Malaysia

Abstract

This paper introduces an in-depth discussion of the various interpretations of what fashion is, and the items considered as part and parcel of fashion. Generally fashion is seen as an object of beautification for women, yet it brings new meanings to their lives when it enhances self-confidence, facilitates the communication of their self-identity and self-esteem, besides depicting their culture or society. A discussion of the purposes of fashion items such as shoes, makeup/cosmetics, apparel and accessories is discussed. A section of the paper is devoted to a discussion of the Muslim scarves (hijab), as the focus of this paper is on the perception of what fashion means to Muslim women. This paper serves as a fruitful insight into the minds of the Muslim women consumers and provides impetus for the marketing of fashion-related items to serve this segment of the market. A conceptual framework developed for this study would be the initial attempt at developing a more comprehensive study into the related moderating and mediating variables that has an effect on fashion. This study also suggests that future researchers may consider testing the proposed model empirically, not only in Malaysia but also in other countries. Lastly, a promising attempt would be to test for invariance among different countries on the same model.

Keywords: Fashion, muslim women

Introduction

Men and women perceive fashion in the same way and it holds importance for both genders equally. However, women's fashion holds more prominence as women are considered more fashion conscious than men, it tends to attract lots of people. Giving this fact, every year new designer clothes are made on a large scale keeping in view the current fashion (Kaiser and Chandler, 1984).

Apart from this, another aspect that greatly impacts women's fashion is beauty. Therefore, it becomes quite important to be mindful about various beauty trends to match with the latest fashion. Being acknowledged about beauty trends may include various facets, for instance: makeup, footwear, accessories, clutches, matching belts, etc. In simple words, anything that helps in beautifying oneself (Park, 1996, Tan, 1987; Sureshchandra, 2001).

In Malaysia, fashion items are the most purchased items through online sites. Besides clothing, which contributed 54% of all purchases done in the festive seasons, bags and accessories are also a favourite item (53%) (www.venusbuzz.com/).

In fact, it was reported in the Malaysian Ecommerce Index of August 2013 that, clothing, accessories and jewellery items are the most bought items online contributing 59.5% of all online purchases, more than health and beauty and consumer electronics. Jewellery is also another fashion items for Malaysian women. Malaysia has become a potential market for various international brand costume jewellery as it is favoured over real ones for safety reasons. The market for real jewellery is also in demand, with many outlets such as Habib Jewels, Poh Kong, Wah Chan, to name a few.

The market for cosmetics has also been encouraging. Malaysia External Trade Development Corporation (MA), reported that the total market for cosmetics was valued at RM321.2 million with imports of cosmetics and toiletries accounting for 72.3% of the domestic consumption in 2012. Clothing for the Muslim women has evolved from the modest Baju Kurong and Kebaya to the more elegantly decorated jubah worn with modern looking head scarfs, blouses, pants, and skirts. A lot of online shopping sites offer the women abundance of choices in materials, designs and colours. Some of these are, Summaya, Zalora, Lazada, and many others.

Fashion is perceived in many ways. Some people see fashion as means of self-expression and beautification. People may dress up in a way that would help them to be associated with a particular clan of people while others dress themselves up like their favorite artist (Jonathan, 1982; Sproles, 1979; Summers, 1970). Apart from this, some people do not like to associate themselves as being fashion conscious and intentionally keep themselves away from the conventional fashion just because they want to be seen as unique in themselves (Kacen, 2000; Kaiser, 1974; Kwon, 1991). However, others may not like to follow fashion trends just because of the mere looks or the current fashion does not hold any importance for them.

Dressing up is part of fashion and it serves as a mean of identifying oneself with others. Cash (1990), Kwon (1991) and Lang (1961) suggested that it becomes important for people to ensure that the way they dress up is accepted by a particular culture or society of which they want to become a part of. If, however, the way a person carries himself does not suit with the

traditions of a society then that individual may change his dress up the way acceptable (Fenigstein *et al.*, 1975; Gould, 1989).

Fashion also communicates one's self-identity (Lang, 1961; Robinson, 1958; and Nam *et al.*, 2006). When an individual is keeping oneself updated with a current fashion knowingly and unknowingly he/she is communicating to the society of who they are and what is important for them. Also it is quite likely that a specific pattern of dressing may be viewed as completely different in two different countries giving their different beliefs and cultures (Manrai, 2001; Park, Richards & Sturman, 1977; 1996; Richards, 1977). For instance, wearing of skirts is seen as normal in the western cultures whereas, the same pattern of dressing sense is not acceptable in Islamic countries like Saudi Arabia, Afghanistan, Pakistan, etc. Therefore, it becomes quite significant to be aware of the society, culture and beliefs that an individual is living in while they follow latest fashion trends. Hence, it becomes inevitable to explore those factors that are considered "fashion" by Muslim women.

Objectives

The main objective of the present research is to explore those factors that are considered fashion by Muslim women. Further, based on the extensive review of the literature, of the past almost half a century, a conceptual model is also proposed for future empirical testing.

Literature review

According to Psychologist Hurlock (1929) "Fashion is something that keeps changing as a series, when the choices of certain group of people change, which may or may not be complemented by utility, nor are decided by it." From an economics and marketing perspective, Nystrom (1928) stated that "fashion is simply a style that becomes popular for a given period of time." Retailer Daniels (1951) also suggested somewhat the same definition of fashion as "anything that becomes suitable/apt for that current period of time."

Lang (1961) is of the view that fashion "Is a basic form of behavior, wherein the driving force is exhibited through the inherent following and conscious decision of the various masses." Robinson (1958) more generally defined fashion as "a hunt for originality for its very own purpose." Fashion is also considered an ever-changing design of various things to make them more attractive (Robinson, 1961). Further, according to King (1964), "adopting fashion is a social taint by which a consumer adopts a novel style or item when it is introduced by the producer, designer or the retailer."

Fashion is continuously being used in today's world to help people express their identity. Clothes and fashion are becoming a medium for

people to express their behavior. According to Cash (1990), Kwon (1991), and Humphrey *et al.* (1971) people adopt latest fashion in order to raise their self-esteem. These researchers are of the view that when people wear good clothes and are up-to-date with the current fashion, they tend to stay more positive, are more proficient in their work and are more extroverts as compared to people who do not feel good about their appearances. Fashion communicates something about ourselves and Stone (1962), summarizes this clearly in his statement that, “a person’s appearance announces his identity, shows his values, and expresses his mood, or proposes his attitude.”. Evan (1989) summed it up by stating that, “ fashion consumption is often a manifestation of self-image.”

Fashion conscious behavior becomes a significant factor while observing the self-concept of fashionable people Fenigstein *et al.* (1975). Gould (1989) and Fenigstein *et al.* (1975) examines that self-consciousness of fashionable consumers becomes the foundation for concept of fashion consciousness. Fashion consciousness as described by Nam *et al.* (2006) “is the degree to which an individual is involved with the fashionable apparel”. Therefore, according to Richards and Sturman (1977) and Kaiser and Chandler (1984) the clothing retailers find this feature (fashion consciousness) in an individual opportune, as they do not have to put many efforts to make a consumer develop an interest in any fashion apparel discounts/promotions. Any person interested in fashionable apparel and his/her appearance can be considered as fashion conscious; it is not important that an individual has to be a fashion modernizer to be termed as fashion conscious (Kaiser, 1984; Manrai, 2001; Park, 1996; Richards, 1977). Fashion consciousness varies by country. This is evidenced from a study conducted by Parker *et.al.*, (2004), where significant differences were found between Chinese teens and their Japanese and US counterparts. However, fashion is not only clothing or accessories. The meaning of fashion is different for different people (Tan, 1987; Walsh, 2001). Like everything else, people have a different point of view about fashion. For some, it involves only clothing while for others; it may include shoes, bags, purses and other similar things (Tan, 1987; Sureshchandra, 2001; Park, 1996; Richards, 1977; Patterson, 2002; Shim, 1997). Some individuals tend to believe that makeup is the only thing that constitutes as fashion. According to Summers (1970), Sproles (1979), Jonathan (1982), Kacen (2000), Kaiser (1974) and Kwon (1991) fashion is a very broad and general term and encompasses a lot of components that make it a whole. In fact, new things are added into the fashion genre every day. For example, having a snazzy phone cover would not have been considered such a big part of fashion two or three years ago. But today, people consider it essential to have cellphone covers matching to their outfit or at least that their phones look really attractive and flashy.

There are many important aspects of fashion but the focus of this paper would be on those facets, which are extracted from the review of the literature. These are also those aspects that the scholars have shown agreement in considering it as a dimension of fashion. In the following section, these facets will be highlighted separately in light of the literature.

Shoes

Shoes are considered as one of the most important fashion items. According to a survey in the USA, each person holds about an average of 10 pairs of shoes and about 20 billion of shoes are produced worldwide per year (Albers *et al.*, 2008; Kalita, 2004; Joan, 2011; Kim, 2002; Kumar, 2000). Footwear or shoes, includes many categories and types like high heels, sports shoes, sandals etc. Shoes can be designer-made, custom-made or produced in masses. Kumar (2000) and Russel (2003) are of the view that people see shoes as an extension of identity. He, along with Nam (2007), Neill (2007), Parson (2003), Perry (2011), Roslow (2000) and Saha (2010) suggested that people perceive their shoes as not only an extension of one's identity, but also as having effects on the individuals perception about oneself and on others. For instance, women in Korea, who are more image conscious, buy shoes that look more attractive and appealing, without putting much emphasis on the quality (Yoh *et al.*, 2011). However in America, women buy only branded shoes as they consider the shoes as an extension of their expression and identity (Belk, 2003; Roslow, 2000).

Shoes, sometimes also referred to as footwear, can be a captivating item in clothing that help us express our identity, giving an insight to who we are and what we can accomplish (Arnold, 2001; Belk, 2003; Chaudhri, 2006; Clarke, 2002; Goodman, 2011; Koda, 2011; Luce, 1998). Belk (2003), Lancioni (2006) and Seferin and van der Linden (2012) explicated that women's shoes represent a symbol of power and status in the society. In addition to these, Mulhern *et al.* (2003), Nosek *et al.* (2002), Fatt (2000) and Creekmore (1974) postulated that women are very much attracted and give much attention to the footwear that they buy because of comfort and their personal choices. The behavior that is depicted by a woman when it comes to shoes shows how important footwear can be to women. The painstaking efforts that women go to in order to have flattering footwear clearly demonstrates that it is not only a symbol of fashion but also the mental satisfaction of creating a good impression.

Makeup/Cosmetics

When it comes to management of ones looks, it not only limits to clothing or apparel but it can include cosmetics, bags, watches and any other items that helps an individual to add glamour to their appearance. People

tend to purchase more clothes of different brands and flashy colors and cuts to enhance one's social image, in similar manner cosmetics of various brands are preferred by people to enrich an individual's style and appearance (Aaker, 1997; Brown *et al.*, 1990; Bulace, 2000; Cash, 1988; Cash *et al.*, 1989; Craik, 1993). According to Beil (1993), Jamal (2001), Fournier (1994) and Kaiser (1997), it has been seen that when women purchases clothes, the makeup usually follows it. This means that women purchases the cosmetics that complement their clothing to develop a perfect eye catching look. Craik (1993) explicated "make-up as something that engraves the features of who we are, and our personality on our body". Having said that, this means that make-up not only helps us to give a complete eye-catching look but it also reflects "optimistic affirmation of an individual's own self".

It is seen in the western world that women usually use make-up to enhance their attractiveness physically. According to Mulhern *et al.* (2003), Wood (2004), Aucoin (1997), Chao (1998), Cox (1986), Fatt (2000), Kyle (1996) and Nosek *et al.* (2002), cosmetics play an important role when it comes to enhancing ones attractiveness because they improve the overall symmetry of the face. For example, foundation and concealer helps to even down the patches and blemishes or pimples on the face resulting in the perfect and smooth skin while covering all the imperfections, lip-stick and eye make-up helps to beautify and even tone an individual's lips and eyes (Aucoin, 1997; Johnson *et al.*, 1997; Quant, 1996). According to Belk (1984), Elliott (1994), Freitas *et al.* (1997) and Banister and Hogg (2004), if there is uniform evenness in the overall body and face of both sexes, they are automatically perceived as attractive. This uniform symmetry can be useful for both women and men to represent a confident, vibrant and self-possessed character, which can help them to take advantage in the work/employment setting.

Cash *et al.* (1989), Beil (1993), Jamal (2001) and Brown *et al.* (1990) are of the view that women tend to be more self-confident and can express themselves more openly and positively when they have make-up on, as compared to when they are without make-up. Creekmore (1974), while addressing clothing as an "adaptive function", suggested that it could help an individual to enhance ones appearance and feeling about oneself. In a similar manner, cosmetics also help women to feel confident and self-assured about themselves.

Apparel & Accessories

All facets that involve management of an individual's external looks or appearance are significant to the process of fashion. Scholars like Rudd and Lennon (2000), Wood (2004), Tidwell *et al.*; (1992) and Malhotra (1981)

described dress as “as an action of selecting and deciding how and with what products/things can an individual beautify his/her personal appearance”.

According to Zaichkowsky (1985), Mayer and Belk (1985), Goldsmith *et al.* (1996), O’Cass (2000), Chowdhary (2000), Kozar (2005) and Hansen and Jensen (2009), women are more fashion conscious and are more attracted to fashion apparel as compared to men because it (apparel) helps to build ones identity. Kaiser and Freeman (1989), Ogletree *et al.* (1990), Bakewell and Mitchell (2003), Piamphongsant and Mandhachitara (2008), Hansen and Jensen (2009) and Workman and Lee (2011), are of the view that women, as compared to men, are more sentient about their looks and personality. Women are seen to pay more attention to their appearance in comparison to men. Researchers Banister and Hogg (2004) further mentioned that women use fashionable clothing as a way to enhance/improve their self-identity and their self-image. Every woman wants to look unique and distinct from one another and it holds more importance to teenagers. However, other researchers like Greco (1986), Rocha *et al.* (2005), Birtwistle and Tsim, (2005), Szmigin and Carrigan (2006), Borland and Akram (2007), Kozar and Damhorst (2008) and Thomas and Peters (2009) totally contradicted by stating that women of every age group whether young or elderly hold the same obsession about fashionable apparel and fashion consciousness, their obsession with good-looks does not fade away with age. Kozar and Damhorst (2008), Majima (2008) and Thomas and Peters (2009) postulated that in most cases the family or close friends of the aged and elderly women help them to guide in the selection of apparel that focus more on maintaining the self-esteem and the self-identity in the society.

Discussion about Fashion is not complete, if it does not involve accessories. Accessories can involve anything ranging from stocking, gloves, headscarves, sunglasses, hats, belts, jewelry and other hosiery items (Pemala, 1997). However, according to Curan (1996), Dardis *et al.* (1981) and Hessen (1996) when a person talks about Fashion, the first thing that comes to our notice is apparel. Nonetheless, as the topic about fashion broadens, one can see the importance of accessories in fashion as they solely help in enhancing the attractiveness of an outfit (apparel). Moreover, Nelson (1989), Norm (1992), Wagner (1983) and Mckay (1994) suggests that many women believe that apparel alone is not enough to beautify them, but rather, accessories play a major role in adding attractiveness to their looks. Therefore, just as we can say that fashion is not limited to apparel; we can say accessories are much more than just the fashion items (Deaton, 1980; Douthitt, 1988; Silverman, 1996; Zhang & Norton, 1995).

Hijab

Hijab as a symbol of Islam serves as an identity of the Muslim woman showing her devotion and sincerity to her religion (Islam) and helps

her being identified as belonging to the Muslim community (Dunkel *et al.*, 2010). Hijab or covering of head is considered the only way by which women can keep herself distant from all the *fitnah* and endure respect for her in this *Dunya* and *Akhirah*. In the current society, a woman does not veil while at home and outside they wear attractive clothing and accessories along with their Hijab to make them look attractive in the society (Afifi & Abdullah, 1921; Khairat & Ahmed, 1975; Al-Hamid & Muhammad, 1978). According to the Holy Quran in Surah 33:59 and in Surah 24:31 “*the women are not allowed to display her personal charms to anyone except her husband*”. Islam is not a severe religion; women can look good but within the limits that are prescribed in Quran and Sunnah. According to Yusr and Viren (2009), Abbas (2005), Ahmed (1992), Allen (2005), Ruby (2004), Ben and Jawad (2004), Rayuso (2008) and Monkeayeva (2012) now-a-days women cover their heads wearing tight fitting Abaya with different designs and glitteriest look that highlight curves of their body and modestly underlining their best features. Islam does not prohibit women to wear good scarves or veils, veils with a little embroidery within the bounds of Islamic decorum are allowed unless and until they are worn in the right manner without showing of hair and shape of their body.

One of the inborn distinctive characteristics of a human being is striving to look unique and different from others and this characteristic becomes more important when it comes to fashion. Abbas (2005), Neilsen (2001), Vassilis *et al.* (2009), Ruby (2004), Sheridan (2004) and Swami and Hull (2009) suggested that fashion is not just restricted to what we wear but it also depends on other products that include jewelry, perfumes, footwear and Hijab etc. Basically, we can say anything that adds attractiveness to our looks. Muslim Fashion is continuously becoming a recent interest in the fashion line. With inspiration from Western countries, fashion magazines greatly influence Muslim girls to look great in their outfit at the same time covering their Body (Latiff & Fatin, 2013; Robinson *et al.*, 2012; Toprak & Uslu, 2009; Reeves & Azam, 2012; Monkebayeva, 2012). Further, Hanzee and Chitsaz (2011) and Latiff and Fatin (2013) and Robinson *et al.* (2012), are of the view that the role of media gives a kind of exposure to this kind of thinking and show them new ways of wearing Hijab that gives them perfect attractive look, while covering their body. Muslim women, especially today’s generation, are continuously looking for new ways where they can stay up to date with the current fashion and also keep themselves covered, so Muslim designers design clothes and started mixing Hijab with the latest fashion which has blurred the main reason and true meaning of Hijab (Chachi, 2008; Latiff, 2013; Monkebayeva, 2012; Reeves & Azam, 2012; Toprak & Uslau, 2009; Zwick & Chelariu, 2006;).

Therefore, this inner dilemma of a woman to stay attractive even while covering her head is solved when hijab becomes trendy (Abbas, 2005; Ben & Jawad, 2004; Buraey, 2004; Latiff & Fatin, 2013; Rayuso, 2008; Ruby, 2004). Many researchers, like, Hanzee and Chitsaz (2006), Monkebayeva, 2012; Rayuso (2008), Robinson *et al.* (2012), Toprak and Uslu (2009), Yusr and Viren (2009), and Zwick and Chelariu (2006) are of the view that this dilemma arises when Muslim women are confused between keeping the modesty in their Hijab according to Islam and following the fashion trends by wearing stylish hijab according to modern fashion that fashion industry demands.

Proposed model

The broad examination of the existing literature brought up four main constructs related to fashion; namely, shoes, makeup/cosmetics, Apparel & accessories and Hijab. These facets, as emerged from the literature, are also measured carefully by the authors in assembling the planned model for Hijab as a symbol of fashion. In the projected model (see Figure 1) the four main constructs are treated as independent variables. All these independent variables are supported by the literature and are testified to have positive effect on fashion consciousness.

Figure 1
Conceptual Model of the study

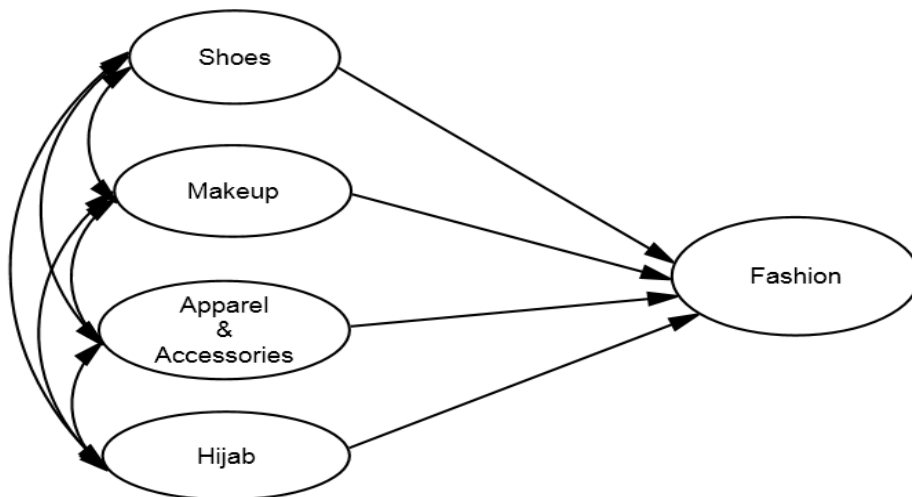

Proposed methodology

For future researchers, who wish to adopt the model of the present study and embark on an empirical testing, it is suggested to follow some important steps in order to test the model. Firstly, data should be collected

from females of different age, education and income level in Malaysia, but special care should be taken, as the study focuses on Muslim women only.

Secondly, the collected data should be checked for any missing responses, outliers and normality, in order to prepare it for further analyses. Reliability tests should be conducted to check the consistency of the scale, followed by exploratory factor analyses (EFA) to find out the number of dimensions underlying the data. It is also an important stage because this way the proposed dimensions and the explored dimensions can be compared. Thirdly, the explored dimensions should be confirmed through confirmatory factor analyses (CFA). This step will help to test for the validity of the instrument too. Finally, the causal linkages or hypotheses, as devised, may be tested to see the impact of the proposed variables on Muslim women fashion.

Conclusion

From the detailed review of the literature on the topic, it is evident that there are many factors that can be crowned as fashion with regard to the perception of women. These factors include: shoes, makeup/ cosmetics, apparel and accessories, and hijab. As this study intended to explore factors from Islamic perspective, especially Muslim women, it can be noted that “Hijab” was also researched and associated with fashion. The present paper, therefore, conceptualized many imperative factors and proposed a model for further investigation and empirical testing, as a valuable contribution to the literature.

References:

- Aaker, J. L. (1997). Dimensions of brand personality. *Journal of Marketing Research*, 347-356.
- Abbas, T. (2005). *Muslim Britain: Communities under pressure*. London: Zed Books.
- Afifi, A. (1921). *Al-Mar's I-Arabia ,fi Jahiliyatih Wa Islamiha*. Egypt: Dar Ihya' Al Kutub el-Arabiyya Publishing House.
- Ahmed, L. (1992). *Women and gender in Islam: Historical roots of a modern debate*. New Haven, CT: Yale University Press.
- Al-Hamid, M. (1978). *Rahmat-UI-Islam Lil Nissa*. Cairo: Dar El-Ansar.
- Allen, C. (2005). *From race to religion: The new face of discrimination*. In T. Abbas (Ed.), *Muslim Britain: Communities under pressure*. London: Zed Books.
- Arnold, R. (2001). *Fashion, Desire, and Anxiety: Image and Morality in the 20th Century*. I.B. Tauris, London.
- Aucoin, K. (1997). *Making faces*. London:Prion.

- Beil, A. (1993). *Converting image into equity*. Hillsdale, NJ.: Laurence Erlbaum Associates.
- Belk, R. W. (2003). "Shoes and Self". *Advances in consumer Research*, 27-33.
- Benn, T., & Jawad, H. (2004). *Muslim women in the United Kingdom and beyond: Experiences and images*. Boston.
- Brown, T. A., Cash, T. F., & Mikulka, P. J. (1990). Attitudinal body-image assessment: factor analysis of the Body-Self Relations Questionnaire. *The journal of Personality Assessment*, 135-144.
- Bulace, W. (2000). "Is branding more than a cosmetic issue?.". *Retail World*, 1-20.
- C., C. (1996). Accessories biz headed for healthy holiday sales. . *Womens wear daily*, 12.
- Cash, T. F. (1988). "The psychology of cosmetics: a research bibliography". *Perceptual and Motor Skills*, 455-460.
- Cash, T. F., Dawson, K., Davis, P., & Bowen, M. (1989). "Effects of cosmetics use on the physical attractiveness and body image of American college women. *Journal of Social Psychology*, 349-355.
- Chao, A., & Schor, J. B. (1998). Empirical tests of status consumption: Evidence from women's cosmetics. *Journal of Economic Psychology*, 107-131.
- Chaudhuri, A. (2006). *Emotion and Reason in Consumer Behavior*. NY.: Elsevier, New York.
- Clarke, A., & Miller, D. (2002). " Fashion and anxiety". *Fashion Theory*, 191-213.
- Cox, C., & Glick, W. (1986). Resume evaluation and cosmetics use: When more is not better. *Sex Roles*, 51-58.
- Craik, J. (1993). *The Face of Fashion: Cultural Studies in Fashion*. Routledge, London.
- Curan, C. (1996). Accessories biz headed for healthy holiday sales'. *Womens wear daily*, 1-12.
- Curwen, L. G., & Park, J. (2014). When the shoe doesn't fit: female consumers' negative emotions. *Journal of Fashion Marketing and Management*, 338-356.
- Daniels, A. H. (1951). Fashion merchandising. *Harvard Business Review*, 51-60.
- Dardis, R., Derrick, F., & Lehfled, A. (1981). Clothing demand in the United States: A cross-sectional analysis. *Home Economics Research Journal*, 212-222.
- Deaton, A., & Muellbauer, J. (1980). *Economics and Consumer Behavior*. Cambridge: Cambridge University Press.

- Dias, L. P. (2003). Generational Buying Motivations for Fashion. *Journal of Fashion Marketing & Management*, 78-86.
- Douthitt, R. A., & Fedyk, J. M. (1988). The influence of children on family life cycle spending behavior: Theory and applications. *Journal of Consumer Affairs*, 220-248.
- Farah Adilla. (Monday 7 April 2014). *Malaysia's 2014 IT Spending to Increase*. Retrieved March 23, 2015 from Malaysian Reserve, All Business Daily at: <http://themalaysianreserve.com/>.
- Fatt, J. P. (2000). Attractiveness and outcome of job interviews. *Management Research News*, 11-18.
- Fenigstein, A., Scheier, M. F., & Buss, A. H. (1975). Public and private self-consciousness: assessment and theory. *Journal of Consulting and Clinical Psychology*, 39-50.
- Fournier, S. (1994). *A consumer-brand relationship framework for strategy brand management*. Gainesville,FL.: unpublished doctoral dissertation, University of Florida.
- Goodman, L. (2011). "Comment: on respondent-driven sampling and snowball sampling in hard-to-reach populations and snowball sampling not in hard-to-reach populations",. *Sociological Methodology*, 347-353.
- Gould, S. J., & Stern , B. B. (1989). "Gender schema and fashion consciousness. *Psychology and Marketing*, 129-145.
- Guthrie, M., Kim, H. S., & Jung, J. (2008). The effects of facial image and cosmetic usage on perceptions of brand personality. *Journal of Fashion Marketing and Management*, 164-181.
- Hanzaee, K. H., & Chitsaz, S. (2011). A review of influencing factors and constructs on the Iranian women's Islamic fashion market. *Interdisciplinary Journal of Research in Business* , 94-100.
- Hessen, W. (1996). Accessories going by the book. *Women's Wear Daily*, 1-8.
- Humphrey, C., Klaasen, M., & Creekmore, A. M. (1971). Clothing and self-concept of adolescents. *Journal of Home Economics*, 246-250.
- Hurlock, E. B. (1929). *The Psychology of dress*. New York: Ronald Press.
- Jamal, A., & Goode, M. H. (2001). "Consumers and brands: a study of the impact of self-image congruence on brand preference and satisfaction". *Marketing Intelligence & Planning* , 482-492.
- Joan, L. M., & Lauren, M. J. (2011). Companion shoppers and the consumer shopping Experience . *Journal of Relationship Marketing*, 7-27.
- Jonathan, G., & Mills, M. K. (1982). Fashion life cycle, self concept, shopping orientation, and store patronage: an integrative analysis. *Journal of Retailing*, 64-87.

- Kacen, J. J. (2000). Gender power and boyyy nature: the past, present and paradisaal future of consumer gender identity. *Marketing Intelligence and Planning*, 345-355.
- Kaiser, H. F. (1974). An index of factorial simplicity. *Psychometrika*, 6-31.
- Kaiser, S. B. (1997). *The Social Psychology of Clothing*. New York, NY: 2nd ed., Fairchild.
- Kaiser, S. B., & Chandler, J. L. (1898). ‘Fashion alienation: older adults and the mass media’,. *International Journal of Aging and Human Development*, 203-221.
- Kalita, J. K., Jagpal, S., & Lehmann, D. R. (2004). Do high prices signal high quality? A theoretical model and empirical results. *Journal of Product & Brand Management*, 279-88.
- Khairat, A. (1975). *The Status of Women in Islam*. Egypt: Dar El-Ma’arif.
- Khare, A. (2014). How cosmopolitan are Indian consumers?: a study on fashion clothing involvement. *Journal of Fashion Marketing and Management*, 431-451.
- Khare, A., Mishra, A., & Parveen, C. (2012). Influence of collective self esteem on fashion clothing involvement among Indian women. *Journal of Fashion Marketing and Management*, 42-63.
- Kim, Y. k. (2002). Consumer value: an application to mall and internet shopping. *International Journal of Retail & Distribution Management*, 595-602.
- King, C. W. (1964). *The innovator in the fashion adoption process Reflections on progress in marketing*. Chicago: American Marketing Association.
- Koda, H. (2011). *100 Shoes: the Costume Institute/The Metropolitan Museum of Art*. New Haven: S.I. Yale Press.
- Kozar, J. M., & Damhorst, M. L. (2008). Older women’s responses to current fashion models. *Journal of Fashion Marketing and Management*, 338-350.
- Kumar, V., & Karande, K. (2000). The effect of retail store environment on retailer performance. *Journal of Business Research*, 167-81.
- Kwon, Y. H. (1991). The influence of the perception of mood and self-consciousness on the selection of clothing. *Clothing and Textile Research Journal*, 6-41.
- Kyle, D. J., & Mahler, H. I. (1996). The effects of hair colour and cosmetic use on perceptions of a female’s ability. *Psychology of Women Quarterly*, 447-455.
- Lang, K., & Lang, G. (1961). *Collective dynamics*. New York: Thomas Y. Crowell.

- Latiff, Z. A., & Alam, F. N. (2013). The Roles of Media in Influencing Women Wearing Hijab: An Analysis. *Journal of Image and Graphics*, 50-54.
- Law, K. M., Zang, Z. M., & Leung, C. S. (2004). Fashion change and fashion consumption: the chaotic perspective. *Journal of Fashion Marketing and Management*, 362-374.
- Luce, M. F. (1998). "Choosing to avoid: coping with negatively emotion-laden consumer decisions". *Journal of Consumer Research*, 409-433.
- Mahmud, Y., & Swami, V. (2009). The influence of the hijab (Islamic head-cover) on perceptions of women's attractiveness and intelligence. *Body Image*, 90-93.
- Malhotra, N. K. (1981). "A scale to measure self-concepts, person concepts, and product concepts". *Journal of Marketing Research*, 456-464.
- Manrai, L. A., Lascu, D. N., Manrai, A. K., & Babb, H. W. (2001). "A cross-cultural comparison of style in Eastern European emerging markets". *International Marketing Review*, 270-285.
- Martin Evans, M. (1989). Consumer Behavior towards Fashion. *European Journal of Marketing*, Vol. 23 Iss 7 pp. 7 – 16.
- McKay, D. (1994). Workshoe sales fueled by fashion. *Footwear news*, 1-2.
- Michon, R., Yu, H., Smith, D., & Chebat, J. C. (2007). The shopping experience of female fashion leaders. *International Journal of Retail & Distribution Management*, 488-501.
- Monkebayeva, K. Z., Bhaitenova, N. Z., & Mustafayeva, A. A. (2012). History of appearance and distribution of hijab and its types. *World Academy of Science, Engineering and Technology*, 1-20.
- Nam, L. A., Hamlin, R., Gam, H. J., Kang, J. H., Kim, J., Kumphai, P., et al. (2006). The fashion-conscious behaviours of mature female consumers. *International Journal of Consumer studies*, 102-108.
- Nash, R., Fieldman, G., Hussey, T., Leveque, L. J., & Pineau, P. (2006). Cosmetics: They Influence More Than Caucasian Female Facial Attractiveness. *Journal of Applied Social Psychology*, 493–504.
- Neill, J. (2007, May 14). *Sample multiple linear regression analysis write-up*", Centre for Applied Psychology. Retrieved May 14, 2009, from available at: <http://wilderdom.com/courses/>: <http://wilderdom.com/courses/>
- Nelson, J. A. (1989). Individual consumption within the household: A study of expenditures on clothing'. *Journal of Consumer Affairs*, 21-44.
- Norum, P. S. (1992). A reassessment of age and gender specifications on household clothing expenditures: Development of age category guidelines for determining clothing allotments. *Clothing and Textiles Research Journal*, 45-54.
- Norum, P. (1999). The demand for accessories, footwear and hosiery: An economic analysis. *Journal of Fashion Marketing and Management.*, 56-64.

- Nosek, B. A., Banaji, M. R., & Greenwald, A. G. (2002). E-research: Ethics, security, design and control in psychological research on the Internet. *Journal of Social Issues*, 161-176.
- Nystrom, P. H. (1928). *Economics of Fashion*. New York: Ronald Press.
- Park, H. (1996). *Global advertising of apparel products: US vs Korean consumer responses*. Ames, IA.: unpublished Master's thesis, Iowa State University.
- Parker, S.R., Hermans, C.M., & Scgaefer, A. D. (2004). Fashion consciousness of the Chinese, Japanese and American teenagers.(2004). *Journal of Fashion marketing & management: An International Journal*, Vol.8.Iss 2, 176-186.
- Parson, A. (2003). "Assessing the effectiveness of shopping mall promotions: customer analysis. *International Journal of Retail & Distribution Management*, 74-79.
- Patterson, M., & Elliot, R. (2002). Negotiating masculinities: advertising and the inversion of the male gaze. *Consumption markets and Culture*, 231-246.
- Perry, D. (2011, April 12). *Alone time: attributes consumers want in mattress retail sales associates*. Retrieved April 12, 2011, from Furniture Today: available at: www.furnituretoday.com/article/536025-Give_
- Piamphogsant, T., & Mandhachitara, R. (2008). Psychological antecedents of career women's fashion clothing conformity. *Journal of Fashion Marketing and Management*, 438-455.
- Rathnayake, C. V. (2011). An empirical investigation of fashion consciousness of young fashion consumers in Sri Lanka. *Journal of Fashion Marketing & Management*, 121-132.
- Rayuso. (2008). *Mass Media Influence on Society*. Retrieved from <http://rayuso.hubpages.com/hub/Mass-Media-Influence-on-Society>.
- Reeves, T. C., & Azam, L. (2012). To wear hijab or not: Muslim women's perceptions of their healthcare workplaces. *Journal of Business Diversity*, 41-58.
- Richards, E. A., & Sturman, S. S. (1977). "Life style segmentation in apparel marketing". *Journal of Marketing*, 88-91.
- Richards, E. A., & Sturman, S. S. (1977). Life style segmentation in apparel marketing. *Journal of Marketing*, 89-91.
- Robinson, D. E. (1958). Fashion theory and product design. *Harvard Business Review*, 126-138.
- Robinson, R. K., Franklin, G. M., & Hamilton, R. H. (2012). The hijab and the kufi: Employer rights to convey their business image versus employee rights to religious expression. *Southern Law Journal*, 79-88.
- Roslow, S., Li, T., & Nicholla, J. F. (2000). "Impact of situational variable and demographic attributes in two seasons on purchase behaviour",. *Eurpoean Journal of Marketing*, 1167-1180.

- Ruby, T. (2004). *Immigrant Muslim women and the hijab: Sites of struggle in crafting and negotiating identities in Canada*. Community University Institute for Social Research.
- Saha, S., Dey, M., & Bhattacharyya, S. (2010). "Factors affecting consumer buying behaviour of shoes in Kolkata: a case study". *The IUP Journal of Management Research*, 39-60.
- Saroglou, V., Lamkaddem, B., Pachterbeke, M. V., & Buxant, C. (2009). Host society's dislike of the Islamic veil: The role of subtle prejudice, values, and religion. *International Journal of Intercultural Relations*, 419-428.
- Sheridan, L. P., & North, A. C. (2004). Representations of Islam and Muslims in psychological publications. *International Journal for the Psychology of Religion*, 149-159.
- Shim, S., & Koh, A. (1997). Profiling adolescent consumer decision-making styles: effects of socialization agents and social-structural variables. *Clothing and Textiles Research Journal*, 9-50.
- Silverman, D. (1996). New age needs home grown fashion seers. *Footwear News*, 1-26.
- Sproles, G. B. (1979). *Fashion: Consumer Behavior Toward Dress*. MN.: Burgess, Minneapolis.
- Summers, J. O. (1970). The identity of women's clothing fashion opinion leaders. *Journal of Marketing Research*, 178-185.
- Sureshchandar, G., Rajendran, C., & Anantharaman, R. (2001). A holistic model for total quality service. *International Journal of Service Industry Management*, 378-412.
- Swami, V., & Hull, C. (2009). Men's ratings of physical attractiveness, health, and partner suitability simultaneously versus separately: Does it matter whether between- or within-subjects designs are used? *Body Image*, 330-333.
- Tan, C. T., & Farley, J. U. (1987). The impact of cultural patterns on cognition and intention in Singapore. *Journal of Consumer Research*, 540-4.
- Tidwell, P. M., Horgan, D. D., & Kenny, C. T. (1992). Brand character as a function of brand loyalty". *Current Psychology: Research and Reviews*, 347-353.
- Tong, D. Y., Lai, K. P., & Tong, X. F. (2012). Ladies' purchase intention during retail shoes sales promotions. *International Journal of Retail & Distribution Management*, 90-108.
- Toprak, M., & Uslu, N. (2009). The headscarf controversy in Turkey . *Journal of Economic and Social Research* , 43-67.
- Venus. *Online Shopping Habits of Malaysian Women*. Retrieved 23/3/2015 from Venus: available at: www.venusbuzz.com/..Nov. 28, 2012.
- Wagner, J., & Hanna, S. (1983). The effectiveness of family life cycle variables in consumer expenditure research. *Journal of Consumer Research*, 281-291.

- Wood, L. M. (2004). Dimensions of brand purchasing behaviour: consumers in the 18-24 age group". *Journal of Consumer Behaviour*, 9-24.
- Yurchisin, J., Kwon, Y. J., & Marcketti, S. B. (2009). Consumers of charity bracelets: cause-supporters or fashion-followers? *Journal of Fashion Marketing and Management*, 448-457.
- Zhang, Z., & Norton, M. T. (1995). Family members' expenditures for clothing categories. *Family and Consumer Sciences Research Journal*, 311-336.
- Zwick, D., & Chelariu, C. (2006). Mobilizing the hijab: Islamic identity negotiation in the context of a matchmaking website. *Journal of Consumer Behaviour*, 380-395.

ISLAMIC PENSION FUNDS PERFORMANCE IN TURKEY

Basak Turan Icke, Assoc. Prof., PhD

Caner Akbaba, Res. Assist, MA

Istanbul University/Faculty of Political Sciences, Turkey

Abstract

Pension funds poses an important place in terms of increasing and encouraging savings for economies of countries. Accordingly, the private pension system in Turkey, which entered into force on 27 October 2003, has been still under development. Therefore, the performance of the pension funds has a considerable indicator characteristic for investors to utilize their savings with these investment instruments. Beside these, in Turkey, for spreading saving ability to all components of the society investors who have Islamic sensitiveness have been channelized into pension funds with new “helal” pension funds. In this study, performance of these pension funds operating in Turkey in the period of January 2013 and August 2015 will be measured by using regression analysis with explanatory benchmarks. For this purpose single and multi regression models will be employed. BIST 100, Government Debt Securities (GDS), and Gold Price Indices will be employed as explanatory variables for the single and multi regression models applied to pension funds.

Keywords: Islamic Pension Investment Funds, Performance Measurement, Borsa Istanbul, Alternative and Participation Funds, Regression

Introduction

Individual pension systems, which are a complimentary system to national social security system, are being implemented in many countries and encourage people to fund their future with voluntary basis. With integration of the individual pension system private pension funds has become an important figure in economies.

People in developed countries mostly have been making savings by investing in pension funds for years. The role of private pensions as a source of income upon retirement has greatly increased over the past two decades, reflecting efforts by many countries to reduce unsustainable pay-as-you-go benefits. (Tapia, 2008)

Especially in OECD countries Pension funds' assets in 2014 top USD 25 trillion. Almost of the OECD countries, pension funds' assets had increased between the end of 2013 and the end of 2014. The greatest growths are found in Estonia, Korea, Luxembourg and Turkey where pension funds' assets increased by more than 20%, compared to their levels between 2014 and 2013. (OECD, 2015)

Pension fund assets showed an average annual growth rate of 8.2% between period of 2009-2013. The five biggest countries in the OECD area in terms of pension funds' assets were the United States, the United Kingdom, Australia, Canada and the Netherlands, altogether totaling USD 21.7 trillion or more than 85% of OECD pension funds' assets. The OECD weighted average asset-to-GDP ratio extended to 86.0%. In United States asset-to-GDP ratio was 84.6% whereas in Turkey this ratio was only 2% at the end of 2014. Pension funds in all the OECD countries offered positive real returns to the investors between December 2013 and December 2014, with an OECD weighted average at 4.5 %. (OECD, 2015)

The first legal regulation of the Turkish Individual Pension Law was completed in 1999 but the official publication was made in 2001 with the "Private Pension Savings and Investment System Law". On 27 October 2003, after the four-year preparation period individual pension system has been engaged in practice with 11 pension companies.

At the end of 2014, there are 19 pension companies and numbers of contracts reached to 5,807,319. The number of participants has grown around 23% and exceeded 5 million when compared to the end of the 2013. In the same period the total net asset value of the funds have been increased 38% surpassed USD 14 billion. Because Islamic Pension funds are in the core of our study, it is needed to give some details about these funds in Turkey. As of December 31, 2014, there are 24 interest – free pension mutual funds with a designation of “Alternative” and “Participation” in their titles, namely 12 in the flexible fund group, 3 in stocks, 2 in precious metals and 7 in standard fund groups. (PMC, 2014)

Fund performance contains various meanings and prominence for both investors and professionals for deciding invest or not to invest funds. Asset management companies are also evaluating the performance of the funds that they manage according to the comparison criteria and comparing the performance of other funds to get an idea on their achievements. Due to these reasons it is required to determine whether funds are managed successfully or not. Conclusively, whether funds are managed well or not can be understood by measuring the performance of funds (Korkmaz and Uygurturk, 2008, p. 115).

In finance literature, many studies have been made for measuring portfolio performance and these studies go back to 1960s. Sharpe (1966)

analyzed performance of 34 mutual funds according to Sharpe Ratio and Treynor Index and he found that majority of these funds did not have better performance than Dow Jones index.

Jensen (1968) examined the performance of 115 mutual funds between the years 1945-1964. In his study Jensen tried to measure selective ability of fund managers with "Jensen's alpha" and he found that managers did not demonstrate any superior performance.

McDonald (1973) calculate monthly returns of mutual funds in the period of the years between 1964-1969 by using Sharpe, Treynor and Jensen criteria and also investigates the relationship between the returns and objectives of the funds. Finally, he found there is a positive relationship between return of the funds and their level of risk.

There are also some other studies on mutual funds performances: Blake, et. al. (1993), Simons (1998), and Detzler (1999) compare the performance of mutual funds with some benchmarks, in general, they found that mutual funds did not show better performance rather than benchmarks.

Thomas et al. (2014) analyzed pension funds in 34 OECD countries from 2000 to 2010 by using panel data analysis, they estimated the impact of pension fund assets invested in stocks and they asserted that the existence of pension funds in the stock markets is beneficial to the financial markets of OECD economies, because they found negative relationship between stock market volatility and presence of pension funds in financial markets.

In Turkey, there are some studies related with portfolio performances: Gürsoy and Erzurumlu (2001), measure mutual funds performances in Turkey they found that performance of mutual funds lagged behind the benchmarks.

Beside studies based on mutual fund performances there are also studies that analyzed pension funds performances in Turkey; Korkmaz and Uygurtürk (2007) tried to measure performances of 46 funds operating between January 2004 and June 2006. Their study proves that whereas funds were successful in uni- and bivariate analysis, funds were not so successful with three variable analysis. Also they asserted that funds performances declined with the increase in the numbers of variables with their analysis.

In another study Korkmaz and Uygurtürk (2008) compared the performances of mutual and pension funds with measuring timing ability of fund managers. In this study it is asserted that pension funds have better performance rather than mutual funds. In addition in this study no mutual fund can show any timing ability, only one pension fund show timing ability in analysis period.

Alptekin and Şıklar (2009) examined the performance of the pension funds from January 2007 to December 2008 by TOPSIS method, which is a multi-criteria decision-making method. At the end of the study funds were

arranged according to their performances.

Kurtaran and Kurtaran (2010) aimed to measure performance of stock growth pension mutual funds with various criteria in the period of December 2003 and December 2006. They asserted that analysis on pension funds performance in Turkey do not give any statistically significant result.

Açıkğöz et al. (2015), analyzed the relationship between the real growth rate of the stock pension mutual funds that have been involved in the individual pension system and the variables such as the number of fund participants, the real fund returns, fund operating expenses and share of fund assets to the total assets of the funds with panel data methodology, they used monthly data cover the period of January 2006 – September 2013. They found that whereas growth of the funds has positive relationship with group share of funds assets and number of participants in relevant fund, there is an inverse relationship between growth of funds and real return of the funds. On the other hand they did not find any relationship between growth of funds and fund operating expenses.

Gökçen and Yalçın (2015) examined Turkish pension funds in the period of 2004 – 2011 they found that pension funds in Turkey shows poor performance and they explain this situation with herding behavior among managers' asset allocation decisions.

In this study, performance of these pension funds operating in Turkey in the period of January 2013 and August 2015 will be measured by using regression analysis with explanatory benchmarks. For this purpose single and multi regression models will be employed. BIST 100, Government Debt Securities (GDS), and Gold Price Indices will be employed as explanatory variables for the single and multi regression models applied to pension funds.

Data And Methodology

Data

In our study we aimed to measure the Islamic Pension funds, which have been operated in Turkey since 2013. The funds, which are designated as “alternative” and “participation” in their titles are accepted interest-free pension mutual funds and suitable for Islamic requirements in finance industry. We include 31 Interest-free pension funds, which have operated in the period of 2013 and 2015 into our analysis. We calculate the weekly returns of these pension funds by following formula. Data for calculating weekly returns of the funds were obtained from Capital Markets Board of Turkey. (CMB, 2015)

$$\begin{aligned}
 R_i &= (R_t - R_{t-1})/R_{t-1} & (1) \\
 R_i &= \text{weekly returns of pension fund } i \\
 R_t &= \text{weekend price of fund } i \text{ in the period } t \\
 R_{t-1} &= \text{weekend price of fund } i \text{ in the period } t-1
 \end{aligned}$$

Variables

In our study, in order to explain the performance of the pension funds we use some explanatory variables by taking into consideration the portfolio structure of the pension funds these are Borsa Istanbul 100 index (BIST 100), Turkey Government Zero Coupon 3 year yield (Risk Free Rate) that is accepted as risk free rate and Gold Mining Price Index (GOLD Index). We obtain index data from Thomsonreuters.com.

We also calculate these indexes weekly return by following formula:

$$\begin{aligned}
 R_i &= (R_t - R_{t-1})/R_{t-1} & (2) \\
 R_i &= \text{weekly returns of index } i \\
 R_t &= \text{weekend price of index } i \text{ in the period } t \\
 R_{t-1} &= \text{weekend price of index } i \text{ in the period } t-1
 \end{aligned}$$

Methodolgy

In this study in order to explain the performances of pension funds we employ regression analysis between variables. In our study, three different regression analysis is performed for pension funds. First regression analysis is applied between weekly return of fund *i* and BIST 100. Second analysis is performed between fund *i* with BIST 100 and Risk Free Rate. Finally, third regression is realized between fund *i* with BIST 100, Risk Free Rate and GOLD Index.

$$RFUND_{it} = \alpha_i + \beta \times BIST100_t + \mu \tag{3}$$

$$RFUND_i = \alpha_i + \beta_1 \times BIST100_t + \beta_2 \times Risk\ Free\ Rate_t + \mu \tag{4}$$

$$RFUND_i = \alpha_i + \beta_1 \times BIST100_t + \beta_2 \times Risk\ Free\ Rate_t + \beta_3 \times GOLD_t + \mu \tag{5}$$

Findings

Unit Root Test

Since the model estimated with non-stationary time series causes spurious regression problems, the results obtained do not reflect the real relationship between variables. Therefore, in this study in order to be sure that the time series are stationary or non-stationary unit root test is performed. One of the unit root tests is Augmented Dickey–Fuller (1981) that is used for examining the time series stationary in this study.

Dickey-Fuller (DF) test is performed on the basis of three regression equation:

$$\begin{aligned}
 \text{None trend and intercept} & \quad \Delta Y_t = \gamma Y_{t-1} + \mu_t \\
 \text{Intercept} & \quad \Delta Y_t = \alpha_0 + \gamma Y_{t-1} + \mu_t \\
 \text{Tend and intercept} & \quad \Delta Y_t = \alpha_0 + \alpha_{1t} + \gamma Y_{t-1} + \mu_t
 \end{aligned}$$

In unit root test we test the hypothesis H_0 : Data is stationary and H_1 : Data is not stationary. Unit root results of our study are presented in table

Table 1: Unit Root Test Results

CO DE	PENSION FUND	ADF Statist ics	McKinnon Critical Values		
			1%	5%	10%
AER	ANADOLU HAYAT EMEKLİLİK A.Ş. ALTERNATIVE CONTRIBUTION PMF	- 3.2426 2*	- 2.58 5050	- 1.94 3612	- 1.61 4897
AG A	ASYA EMEKLİLİK VE HAYAT A.Ş. GOLD PARTICIPATION PMF	- 8.7949 86*	- 2.58 4539	- 1.94 3540	- 1.61 4941
AG B	ASYA EMEKLİLİK VE HAYAT A.Ş. GROWTH PARTICIPATION FLEXIBLE PMF	- 15.939 62*	- 2.58 1951	- 1.94 3175	- 1.61 5168
AG D	ASYA EMEKLİLİK VE HAYAT A.Ş. PARTICIPATION STANDARD PMF	- 2.7610 49*	- 2.58 5587	- 1.94 3688	- 1.61 4850
AG E	ANADOLU HAYAT EMEKLİLİK A.Ş. ALTERNATIVE FLEXIBLE INCOME PMF	- 11.508 64*	- 2.58 1951	- 1.94 3175	- 1.61 5168
AG G	ASYA EMEKLİLİK VE HAYAT A.Ş. GROWTH GROUP PARTICIPATION FLEXIBLE PMF	- 11.088 02*	- 2.58 1951	- 1.94 3175	- 1.61 5168
AG H	ASYA EMEKLİLİK VE HAYAT A.Ş. STOCK PARTICIPATION GROWTH PMF	- 12.178 94*	- 2.58 1951	- 1.94 3175	- 1.61 5168
AG M	ASYA EMEKLİLİK VE HAYAT A.Ş. FLEXIBLE PARTICIPATION PMF	- 4.7260 90*	- 2.58 2204	- 1.94 3210	- 1.61 5145
AG T	ASYA EMEKLİLİK VE HAYAT A.Ş. ALTERNATIVE CONTRIBUTION PMF	- 2.2273 16**	- 2.58 5587	- 1.94 3688	- 1.61 4850
GE A	GARANTİ EMEKLİLİK VE HAYAT A.Ş. ALTERNATIVE FLEXIBLE PMF	- 11.456 26*	- 2.58 1951	- 1.94 3175	- 1.61 5168
GES	GARANTİ EMEKLİLİK VE HAYAT A.Ş. ALTERNATIVE STANDARD PMF	- 3.0355 53*	- 2.58 6550	- 1.94 3824	- 1.61 4767
GH L	GARANTİ EMEKLİLİK VE HAYAT A.Ş. ALTERNATIVE CONTRIBUTION PMF	- 3.6444 45*	- 2.58 5050	- 1.94 3612	- 1.61 4897
HEE	AXA HAYAT VE EMEKLİLİK A.Ş. ALTERNATIVE FLEXIBLE GROWTH PMF	- 9.0694 94*	- 2.58 7607	- 1.94 3974	- 1.61 4676
HER	AXA HAYAT VE EMEKLİLİK A.Ş. ALTERNATIVE CONTRIBUTION PMF	- 6.7315 50*	- 2.59 0065	- 1.94 4324	- 1.61 4464
HH A	HALK HAYAT VE EMEKLİLİK A.Ş. ALTERNATIVE CONTRIBUTION PMF	- 3.8540 85*	- 2.59 1204	- 1.94 4487	- 1.61 4367
HH D	HALK HAYAT VE EMEKLİLİK A.Ş. STANDARD PARTICIPATION PMF	- 4.6487 11*	- 2.58 5962	- 1.94 3741	- 1.61 4818

HH M	HALK HAYAT VE EMEKLİLİK A.Ş. STOCK PARTICIPATION PMF	- 11.188 34*	- 2.58 5587	- 1.94 3688	- 1.61 4850
HH N	HALK HAYAT VE EMEKLİLİK A.Ş. PARTICIPATION FLEXIBLE PMF	- 11.078 44*	- 2.58 5587	- 1.94 3688	- 1.61 4850
KE A	KATILIM EMEKLİLİK VE HAYAT A.Ş. ALTERNATIVE CONTRIBUTION PMF	- 3.8273 62*	- 2.60 7686	- 1.94 6878	- 1.61 2999
KEB	KATILIM EMEKLİLİK VE HAYAT A.Ş. ALTERNATIVE STANDARD PMF	- 3.2287 04*	- 2.60 3423	- 1.94 6253	- 1.61 3346
KEF	KATILIM EMEKLİLİK VE HAYAT A.Ş. ALTERNATIVE GOLD PMF	- 6.9253 23*	- 2.60 2794	- 1.94 6161	- 1.61 3398
KE G	KATILIM EMEKLİLİK VE HAYAT A.Ş. ALTERNATIVE FLEXIBLE PMF	- 6.2872 44*	- 2.60 2794	- 1.94 6161	- 1.61 3398
KE H	KATILIM EMEKLİLİK VE HAYAT A.Ş. ALTERNATIVE STOCK GROWTH PMF	- 7.5108 08*	- 2.60 2794	- 1.94 6161	- 1.61 3398
KE K	KATILIM EMEKLİLİK VE HAYAT A.Ş. GROUP ALTERNATIVE FLEXIBLE PMF	- 6.8569 45*	- 2.60 7686	- 1.94 6878	- 1.61 2999
MH A	METLİFE EMEKLİLİK VE HAYAT A.Ş. ALTERNATIVE CONTRIBUTION PMF	- 6.2164 51*	- 2.59 5745	- 1.94 5139	- 1.61 3983
MH S	METLİFE EMEKLİLİK VE HAYAT A.Ş. ALTERNATIVE STANDARD PMF	- 7.8622 12*	- 2.59 3121	- 1.94 4762	- 1.61 4204
VER	VAKIF EMEKLİLİK A.Ş. ALTERNATIVE CONTRIBUTION PMF	- 10.821 73*	- 2.58 4539	- 1.94 3540	- 1.61 4941
VE Y	VAKIF EMEKLİLİK A.Ş. GROUP FLEXIBLE GROWTH PMF	- 11.833 36*	- 2.58 1951	- 1.94 3175	- 1.61 5168
VG B	VAKIF EMEKLİLİK A.Ş. GELİR AMAÇLI ALTERNATIVE GOVERNMENT DEBT STANDARD PMF	- 5.3640 03*	- 2.58 5587	- 1.94 3688	- 1.61 4850
ZH A	ZİRAAT HAYAT VE EMEKLİLİK A.Ş. ALTERNATIVE STANDART PMF	- 11.007 53*	- 2.58 1951	- 1.94 3175	- 1.61 5168
ZHT	ZİRAAT HAYAT VE EMEKLİLİK A.Ş. ALTERNATIVE CONTRIBUTION PMF	- 2.4552 46**	- 2.58 5587	- 1.94 3688	- 1.61 4850
BIS T10 0	BORSA ISTANBUL 100 ENDEKSİ	- 11.432 35*	- 2.58 1951	- 1.94 3175	- 1.61 5168
GO VT	GOVERNMENT 3 YEAR BOND YIELD	- 11.276 17*	- 2.58 2076	- 1.94 3193	- 1.61 5157
GO LD	GOLD INDEX	- 12.693 08*	- 2.58 1951	- 1.94 3175	- 1.61 5168

*,** shows series are significant at 1% and 5% level of significance respectively.

As it can be observed in table 1, unit root test shows that all of the series are stationary at 1% level of significance except ZHT, however, it has not a unit root at 5 % level of significance.

Results of Regression Analysis

Univariate and multivariate regression analysis results of our study are presented in table 2,3, and 4. Successes of the funds are determined according to α equation from the formula 3,4, and 5. At the end of the analysis funds, which have positive and significant α coefficient, they are accepted successful among other pension funds compared with the benchmark variables

Table 2: Univariate Regression Analysis Results

Code	BIST 100	Alfa
AER	0.01851***	0.001317*
AGA	-0.24451*	0.001615
AGB	0.117886*	0.001412
AGD	0.020736**	0.001033*
AGE	0.157015*	0.001183**
AGG	0.126647*	0.001355*
AGH	0.530542*	0.002209
AGM	0.025525*	0.001249*
AGT	0.016368**	0.001259*
GEA	0.16913*	0.000967**
GES	0.004105	0.001245*
GHL	0.026885**	0.001252*
HEE	0.132488*	0.001401**
HER	0.028268	0.001828*
HHA	0.038992*	0.001863*
HHD	0.012599	0.001172*
HHM	0.536494*	0.001042
HHN	0.201056*	0.000986
KEA	0.014793**	0.001783*
KEB	0.005927	0.001549*
KEF	-0.15252	0.004016
KEG	0.073379*	0.001227**
KEH	0.387725*	0.001232
KEK	0.082738*	0.001885*
MHA	0.027346*	0.001517*
MHS	0.069668*	0.001449*
VER	0.069387*	0.001512*
VEY	0.241243*	0.001327**
VGB	0.078406*	0.001504*
ZHA	0.113595*	0.000988**
ZHT	0.019572**	0.001123*

Table 3: Bivariate Regression Analysis Results

Code	BIST 100	GOVT	Alfa
AER	-0.021235	-0.021235*	-0.021235*
AGA	0.001486	56.57048	0.001217
AGB	0.129409*	8.046274	0.001309
AGD	-0.005863	-15.54572**	0.001142*
AGE	0.150275*	-3.432969	0.001141**
AGG	0.117782*	-4.742617	0.001319*
AGH	0.528991*	1.058865	0.002052
AGM	0.014190	-6.873352	0.001267*
AGT	-0.016739	-19.34923*	0.001395*
GEA	0.146823*	-14.25316	0.001061**
GES	-0.014089	-11.59697*	0.001301*
GHL	-0.024027	-29.75580*	0.001461*
HEE	0.124866*	-4.599344	0.001419**
HER	-0.013377	-25.02859**	0.001971*
HHA	0.022834*	-9.608193	0.001903*
HHD	-0.047834*	-35.52383*	0.001409*
HHM	0.464513*	-42.31239	0.001324
HHN	0.156579*	-26.14462***	0.001160
KEA	0.010077	-2.600889	0.001799*
KEB	0.005045	-0.511397	0.001552*
KEF	-0.058340	54.56162	0.003678
KEG	0.083596*	5.918926	0.001190***
KEH	0.468595*	46.84839	0.000942
KEK	0.092098*	5.161410	0.001854*
MHA	0.021818	-3.229168	0.001531*
MHS	0.061741*	-4.672599	0.001471*
VER	0.027681	-24.37539**	0.001683*
VEY	0.223234*	-10.48343	0.001321***
VGB	0.060363*	-10.61345***	0.001575*
ZHA	0.088385*	-15.57386***	0.001052**
ZHT	-0.017438	-21.63037*	0.001276*

Table 4: Three-variable Regression Analysis Results

Code	BIST 100	GOVT	GOLD	Alfa
AER	-0.014878	-0.014878*	-0.014878	0.001486*
AGA	-0.205967**	54.12397	0.066658*	0.001161
AGB	0.115823**	7.572098	0.016533	0.001336
AGD	0.002427	-15.19754**	-0.009487***	0.001150*
AGE	0.147867*	-3.516996	0.002930	0.001146**
AGG	0.113490*	-4.892421	0.005223	0.001328*
AGH	0.510786*	0.423446	0.022154	0.002088
AGM	0.012404	-6.935685	0.002173	0.001270*
AGT	-0.009906	-19.06226*	--0.007819***	0.001402*
GEA	0.149049*	-14.17546	-0.002709	0.001057**
GES	-0.014037	-11.59000**	-0.000992	0.001301*
GHL	-0.014714	-29.36465*	-0.010657***	-0.010657*
HEE	0.128586*	-4.393636	-0.004087	0.001414**
HER	-0.021642	-25.74240**	0.007761	0.001981*
HHA	0.024418***	-9.464230	-0.001582	0.001902*
HHD	-0.044323*	-35.24322*	-0.003668	0.001413*
HHM	0.438712*	-44.37475	0.026957	0.001294
HHN	0.147300*	-26.88639***	0.009696	0.001150
KEA	0.016283	-1.610249	-0.004333	0.001820*
KEB	0.008370	-0.027516	-0.003074	0.001568*
KEF	-0.217508	31.40328	0.147104*	0.002900
KEG	0.089417*	6.765831	-0.005380	0.001219***
KEH	0.512911*	53.29625	-0.040957	0.001159
KEK	0.112765*	8.460318	-0.014428	0.001925*
MHA	0.022319	-3.142212	-0.000543	0.001533*
MHS	0.068759*	-3.567549	-0.007077	0.001482*
VER	0.035367	-24.05258**	-0.008795	0.001691*
VEY	0.217887*	-10.67004	0.006506	0.001331***
VGB	0.058095*	-10.79452***	0.002361	0.001572*
ZHA	0.092656*	-15.42476***	-0.005199	0.001043**
ZHT	-0.012462	-21.42138*	-0.005694	0.001280*

According to the analysis results, significant α values shows that only 1 of the 31 funds is failed in the given period, that is, 23 funds are successful. In fact, 17 funds are successful at the 1 % level of significance. On the other hand it is also found that adding new variables in to the equation has no effect on the funds performances. Neither sign nor level of significance change has been observed with multi-variate analysis.

Conclusion

Individual pension system such a system that people make investments on voluntary basis and also encouraged to make savings, increases its prominence in the Turkish financial system day by day. In Turkey because of the demographic structure and some people's religious

sensitivities these people preferred to stay away from the financial markets. In 2013, in order to attract these people in accordance with their sensitiveness government make some amendments and pension fund companies are encouraged to make new interest-free pension funds. These “helal” funds are called as “alternative” and “participation” funds.

In our study, we aimed to analyze performance of these funds whether they provide more returns or not when they are compared with the some benchmarks. For this purpose we obtain weekly data of these funds in the period of 2013 and 2015 from website of Capital Markets Board of Turkey and compared them with three benchmarks; Borsa Istanbul 100 Index, Risk free rate in Turkey (which is yield of 3 year bonds), and Gold Index.

Finally, as a result of the analysis, we find that only 1 fund in 31 funds failed, however, 23 of them performed better than benchmarks in the given period. Therefore, these funds stay as a best investment alternative for people who have religious sensitiveness.

References:

- Açıköz, Ersin, Hasan Uygurtürk and Turhan Korkmaz (2015), “Analysis of Factors Affecting Growth of Pension Mutual Funds in Turkey”, *International Journal of Economics and Financial Issues* 5(2), 2015: 427-433.
- Alptekin, Nesrin, and Emel ŞIKLAR (2009), “Türk Hisse Senedi Emeklilik Yatırım Fonlarının Çok Kriterli Performans Değerlendirmesi: Topsis Metodu”, *Dumlupınar Üniversitesi Sosyal Bilimler Dergisi* No. 25 December 2009: 185-196.
- Blake, Christopher R., Edwin J. Elton, and Martin J. Gruber (1993), “The Performance of Bond Mutual Funds”, *The Journal of Business* 66(3) 1993: 371-403.
- Capital Markets Board of Turkey,
<http://www.spk.gov.tr/apps/MutualFundsPortfolioValues/FundsInfosFP.aspx?ctype=E&submenuheader=0> (Access Date: 28/8/2015)
- Detzler, Miranda Lam (1999), “The Performance of Global Bond Mutual Funds”, *Journal of Banking & Finance*, (23) 1999: 1195-1217.
- Dickey, David A., and Wayne A. Fuller, (1981), “Likelihood Ratio Statistics for Autoregressive Time Series with A Unit Root”, *Econometrica* 49, 1981: 1057-1072.
- Gökçen, Umut, and Atakan Yalçın (2015), “The Case Against Active Pension Funds: Evidence from The Turkish Private Pension System”, *Emerging Markets Review* 23, 2015: 46–67.
- Gürsoy, Cudi Tuncer ve Y. Ömer Erzurumlu (2001), “Evaluation of Portfolio Performance of Turkish Investment Funds”, *Doğuş Üniversitesi Dergisi* (4) 2001: 43-58.

- Jensen, Michael C. (1968), "The Performance of Mutual Funds in the Period 1945-1964", *The Journal of Finance* 23(2) 1968: 389-416.
- Korkmaz, Turhan, and Hasan Uygurtürk (2007), "Türk Emeklilik Fonlarının Performans Ölçümünde Regresyon Analizinin Kullanılması", *Zonguldak Karaelmas Üniversitesi Sosyal Bilimler Dergisi* Vol. 3, No. 5, 2007: 37:52.
- Korkmaz, Turhan, and Hasan Uygurtürk (2008), "Türkiye'deki Emeklilik Fonları ile Yatırım Fonlarının Performans Karşılaştırması ve Fon Yöneticilerinin Zamanlama Yetenekleri", *Kocaeli Üniversitesi Sosyal Bilimler Enstitüsü Dergisi* (15) 2008 / 1 :114 - 147
- Kurtaran, Ayten Turan, and Ahmet Kurtaran (2010), "Türkiye'de Emeklilik Yatırım Fonlarının Performans Değerlendirmesi", *Dumlupınar Üniversitesi Sosyal Bilimler Dergisi* No. 26 April 2010, 248-259.
- McDonald, John G. (1973), "French Mutual Fund Performance; Evaluation of Internationally - Diversified Portfolios", *The Journal of Finance*, 28(5) 1973: 1161-1180.
- OECD (2015), "Pension Funds in Figures", OECD Publishing, <http://www.oecd.org/finance/Pension-funds-pre-data-2015.pdf> (Access Date: 28/8/2015)
- PMC (Pension Monitoring Center) (2014), "Individual Pension System Progress Report 2011" www.egm.org.tr/bes2014gr.htm
- Sharpe, William F. (1966), "Mutual Fund Performance", *The Journal of Business*, 39(1), Part 2: Supplement on Security Prices 1966: 119-138.
- Simons, Katerina (1998). "Risk-Adjusted Performance of Mutual Funds", *New England Economic Review*, (September-October) 1998: 33-49.
- Tapia, Waldo (2008), "Description of Private Pension Systems", OECD Working Papers on Insurance and Private Pensions, No. 22, OECD Publishing.
- Thomas, Ashok, Luca Spataro, and Nanditha Mathew (2014), "Pension Funds and Stock Market Volatility: An Empirical Analysis of OECD Countries", *Journal of Financial Stability* 11 2014: 92-103

ONGOING SUPERVISED STAFF TRAINING MODEL : A THEORETICAL PLATFORM FOR HIGH-ORDER THINKING SKILLS COACHING IN A MULTI-DISCIPLINARY ENVIRONMENT

Irit M. Nassie, PhD
Inspire Academy

Abstract

This is an ongoing process of staff-training combined with self-study conducted simultaneously by the team of *Inspire-Academy*, a privately initiated venture aimed at embedding high order thinking-skills in the functional routine of children and their significant adults. The team comprises of the academic principal and three staff trainers. The venture is an advanced and improved offspring of two initiatives undertaken and researched during institutionalized teacher training anchored in an innovative paradigm – MOST⁸⁴ (Nassie, Shani & Bar-on 2008) and Multiple MOST⁸⁵ - (Nassie & Shani, 2009). Having witnessed the impact MOST and had on training and teaching of language arts, Multiple MOST has been introduced consecutively into three training disciplines: Literacy, Mathematics and Art. Disciplines were chosen as a platform for meditative procedures using the language of thinking, due to their close link to language and to thinking. Five years of supervised practice in elementary schools called for widening and adjustments to fit early childhood coaching by professionals of *Inspire-Academy* to youngsters' significant adults through By-Proxy-Mediation.⁸⁶ The benefits of the extended model as a platform for simultaneously training young children and their care takers is investigated.

ECMMI was used to train two groups of which the writer was the moderator: Group One consisted of instructors of *Inspire-Academy* as part of their in-job training. Group Two – comprised of non-professional-adults – parents, grand parents and care givers seeking to maximize their meditative-coaching skills for the benefit of the young children they cater to. Insights gained

⁸⁴ Model of Ongoing Supervised Training MOST- An Innovative approach for teacher training of Thinking and Language

⁸⁵ Multiple MOST - Merging Theory and Practice in Multiple Disciplinary Contexts

⁸⁶ A process in which significant others – co-workers, students or significant adults are being trained to mediate while being mediated to.

through practitioner-reflection resulted in changes in model which is now under intensive investigation.

Keywords: Training, language-of-thinking, parents

Introduction

Context of the study

The conceptual framework of MOST - Model of Ongoing Supervised Training (Nassie, Bar-On and Shani, 2008) - combined pedagogical and disciplinary supervised mentoring replacing two separate field workshops. MOST trainees were exposed to a joint venture using similar pedagogical and disciplinary parameters and a shared jargon for mediating self regulation using the language of thinking in the context of literacy instruction under constant supervision and by modeling the mediators' self regulatory processes.

MOST, was initiated as an innovative training paradigm for teacher training based on the notion of 'multicultural pedagogy' which caters to divergent communities (Hoffman, 1996). Based on philosophies and practice procedures associated with PDS (Professional Development School) and Inclusive Education, it later materialized as a workshop for trainee teachers and in job training for professionals mediating self regulation using the language of thinking primarily in language instruction contexts. It was then broadened to sustain additional disciplines (Mathematics and Art). In its current phase it involves the basic and advanced staff training of *Inspire Academy* a venture aimed at embedding self regulation and high order thinking skills in the functional routine of children.

Several years of practice and research, demonstrated the substantial contribution MOST, and Multiple MOST had on teacher and organizational development in the long run. Evidence proved both models effective in:

- a. Implementation of corrective and therapeutic self regulated decisions during week-long intervals between sessions and bridging the functional gap between individual therapy and the classroom activities.
- b. Trainee exposure and involvement in multi-professional interventions requiring self regulation and introspection.
- c. Empowerment of the staff, the children and the surrounding community by generating a common thinking language- Jargon of a Learning Community (Nassie, 2004), that influences expanding circles of learning and self regulatory behavior.
- d. Evoking consciousness to parallel communication of staff as a meditative community aimed at pre-planning, self regulation and reflection.

e. Evoking consciousness and understanding of the importance of the cultural basis inner speech in self regulation of communication and language thinking in multi-ethnic and socially stratified communities.

Based on these findings, it seemed appropriate to take it one step further by widening the spectrum and transferring the principals upon which MOST and Multiple MOST were constructed, into earlier child education and pre-school, out of school enrichment. Extensive reading and disciplined enquiry proved parents and other care takers were eager to assume responsibility based on empowerment and professional support. The extended model introduced here Early Childhood Multiple MOST Inspiration was therefore introduced into the variety of services offered by *Inspire Academy* thus focusing on a neglected but interested target population and deepening the impact by providing authentic transitive opportunities.

Early **Childhood Multiple MOST Inspiration** was the focus of an in-service and pre-service training program designed for two groups of staff members of *Inspire Academy* : *Group One* consisted of licensed teachers seeking alternative challenges. All members of this carefully selected group had been exposed to the rationale and training when first joining *Inspire Academy*. *Group Two* was part of a continued educational program for teachers conventional environment seeking to improve their practice. Group two was the focus of research into By Proxy Mediation. This divergent population, in terms of disciplines, interests, skills and points of view, allowed for a widening of the spectrum and provided an in-depth critical aspect.

Synergizing the expertise gained through previous enterprises the moderators- experts in assessment, mediation, pedagogy, curricular planning and disciplinary adjustment widened the scope of their expertise to include group-counseling for non professional participants, mediation to young children and modeling. This allowed for a unique opportunity for professional development and growth of all participants in the *Inspire Academy* venture.

Intensive practitioner reflection combined with logs pf the non professional participants and some recorded child generated stories and insights enabled the moderators to introduce the necessary changes into the extended model which is now subject for intensive investigation.

I.

Aims

The purposes of this ongoing study are: (a) Mapping and determining the conceptual parameters which benefit from the change introduced into training and practice. (b) Based on this analysis - to find out whether **Early**

Childhood Multiple MOST Inspiration should be adopted as a platform for *Inspire Academy* staff training in Multiple Disciplinary Contexts and ages. (c) Revealing possible transformations this experience engenders in non professional mediators perception.

In order to do so, data was accumulated and analyzed it in light of the ‘thinking class’ framework. The investigation focused on learning processes which employ the language of thinking during instructive interactions between mentors and their non professional trainees and between these trainees and their respective audiences in what Nassie (2004) called “By proxy mediation”.

Theoretical perspectives

The theoretical perspectives upon which we based our model, as well as the investigation, is our conceptual framework regarding the nature of intellectual performance. We maintain that efficient intellectual performance accelerates learning which, in turn serves as the soil for additional intellectual growth (Vygotsky, 1962) . We agree that intelligence is a varied capacity (Gardner, 1983). Learning performance, by nature is language-based and can therefore best be linked to intelligence by using thinking concepts (Tishman, Perkins & Jay, 1995). We also claim that human functioning is modifiable through adequate mediation. We assume the language of thinking constitutes such mediation (Feuerstein, Falik and Feuerstein, 1998) . The language of thinking used within the learning community served as the anchor for all academic interactions with children, trainees and teachers alike (Nassie, 2004). We maintain that the three disciplines chosen for this investigation – written language instruction, mathematics and art instruction - are most suitable for such a project given that all three are in fact languages, each of which represents a different mode of intelligence - logical, verbal and spatial (Gardner, 1983).

Theories regarding the nature of intelligence

Gardner’s (1983) Theory of Multiple Intelligences (MI) challenged the traditional view of intelligence as a unitary capacity that can be adequately measured by IQ tests. Instead, Gardner defines intelligence as an ability to solve problems or create products that are valued in at least one culture. Feuerstein and the school of Structural Cognitive Modifiability define intelligence as “the capacity of the individual to use previously acquired experience to adjust to new situations” and also as a “process broad enough to embrace a large variety of phenomena that have in common the dynamics and mechanics of adaptation. The adaptability of the organism is what we refer to as modifiability” (Feuerstein et al., 1998). When addressing modifiability, two situations are in fact addressed – that of the ‘normative

achiever’ – striving for excellence, as well as that of ‘under achievers’, for whatever reason, striving for normative performance. The bonding of these two populations is the raison d’être of Inclusive education, which addresses cognitive development and the cognitive functions at one and the same time.

Cognitive Development –Is the process of mental growth taking place through the interaction between the individual and the environment. Interaction with environment may be described: as a direct learning experience – through direct exposure to stimuli, as in the S—R model; as a mediated learning experience that requires the active presence of a human being to filter, select, interpret and elaborate that which has been experienced (Falik,2000)[4]. MLE expands the classical $S \rightarrow R$ behaviourist model of conditioned learning and Piaget’s S---O---R model in which an organism is added to the equation, and places a Human mediator between the stimulus and the response, filtering stimuli and directing responses --- S— H — O — H — R-- . The theory of MLE regards cognitive development as determined, to a great extent, by two major types of interactions: direct learning and mediated learning. The special quality of MLE is viewed as responsible for the flexibility and modifiability of thinking and the enhancement of learning potential (Wang, Haertel, & Walberg, 1990). Through MLE, pupils learn how to learn. Learners who are not exposed to adequate mediated learning experiences tend to manifest undeveloped, impaired or fragile cognitive functioning (Feuerstein et. al.1998). Existing deficiencies do not necessarily emerge as one complete and unified repertoire; rather, the operative cognitive profile is individual and thus dictates intervention in terms of structure and emphasis (Feuerstein et.al 1998). Of the three phases in which deficient cognitive functions can be detected, the elaboration phase is the core of mental processing, whereas the input and output phases can be regarded as peripheral. Interaction analysis between and within phases is highly significant for understanding the extent and expansion of cognitive dysfunction. All three phases are heavily loaded with emotional and motivational factors (Hadas-Lidor 1999).

The Language of Thinking

The link between language and thinking is well established in psychology, education and teaching research. Vygotsky (1986) [15] stresses the importance of dual process (1) when learners master and internalize Language - the symbolic psychological tools of their society, (2) when they create their own symbolic linguistic representations in order to preserve and transcend understanding (Kozulin, 1999). The concept of ‘psychological tools’ is an innovative contribution of Vygotskian theory. They are defined as ‘those symbolic artifacts-signs, symbols, texts, formulae, graphic-symbolic devices that help individuals master their own ‘natural’

psychological functions such as perception, memory and attention' (Kozulin, 1998). An example would be the impact of writing things down from memory, of drawing when solving mathematical problems, and of using pictures to demonstrate and strengthen written reasoning.

In light of the above it seemed appropriate to examine research literature which integrates language-related disciplines with the methods and processes of thinking instruction. Tishman, Perkins and Jay (1995) list six dimensions of 'good thinking', one of which is the language of thinking (LOT) defined as the terms and concepts used within a learning community in reference to thinking and the way language is utilized to encourage high level thinking.

The language of thinking fulfils two highly significant roles in our lives: (1) *Communication* – like any language its purpose is to communicate i.e. to transfer information about our own mental processes in different contexts of our lives. Daily thinking does not always use the formal terminology of thinking, but in scientific or academic contexts users technical terms, such as findings, speculations and inferences are beneficial. In the NCTM standards, communication is one of the standards explicitly discussed, especially as a means of enabling students to organize and consolidate their mathematical thinking. It allows students to verbally share their mathematical thinking with others, analyze and evaluate their thinking as well as others' strategies, and to express mathematical ideas precisely. (2) *Guidance and Order* – the language of thinking is useful for regulating, organizing and guiding thinking. Meta-cognition and the language of thinking are closely connected. The language of thinking provides the terms which propel the meta-cognitive process and organize and evaluate thinking (Tishman et.al. 1995). A specific jargon emerges in an environment thus inclined. This jargon is one basic characteristic of a learning community (Nassie, 2004).

The formation of a functional and cognitive jargon by a learning community is advantageous because it necessitates the redefinition of concepts and positions. Costa and Marzano (1991) identify seven components necessary to the construction of such a jargon:

1. Using precise thinking terminology: Expressions often used in learning environments are 'think more' 'think well' or 'think harder' thus stressing quantity and intensity of thinking over quality. The fact that using specific cognitive terminology assembles a thinking-learning lexicon which guides thinking and actions is sometimes overlooked.

2. Posing critical questions: Costa and Marzano (1991) prefer critical questions to instructions. They would replace "You made a mistake because you didn't notice" with: "What do you think you can do to avoid this sort of mistake in the future?" so that the learner may assume responsibility for his

actions and mistakes and of implementing the necessary principles in different contexts.

3. Presenting data rather than solutions: Sometimes, due to a diversity of constraints or inclinations, teaching and learning focus on solutions and results rather than on the overall process, thus denying the opportunity of learners to search and adapt their own solutions in thus assuming responsibility for their own performance. Readers, for example, can be allowed to make mistakes without immediately being corrected. Reaching a stage where rereading and reorganization of data is necessary allows them to detect errors, correct them, and avoid making the mistake in the future. Correction of spelling or Math errors cannot guarantee long-term flawless spelling or calculating.

4. Providing guidance: When guided, learners may be given information that is so well organized that assignments can be completed without the aid of meaningful cognitive activity except memory. Costa and Marzano (1991) suggest guidance through questions. In a variety of disciplinary contexts questions such as: “What does one need to pay attention to when spelling/drawing/solving a problem...?” would be more effective in terms of cognitive coaching than correction.

5. Striving for Precision: In daily speech we tend to make vague statements and erroneous generalizations. It is important to encourage learners by demonstration to define terms in using precise concepts and by striving to use specific and exact characterizations (Laborde, 1984). Costa and Marzano (1991) identify four categories of vague terminology: (1) Generalizing words – always, never, everyone, at all, etc. These words are very easy to resort to and are often misleading. (2) Vague comparisons – better, newer, nicer, easier - words that are often used but do not include explanation or detail. (3) Arbitrary use of pronouns – they, these – do not refer to anyone specifically, and as such, are less effective. (4) Sweeping generalizations – should, forbidden, must, have to – perceived as obvious in meaning and authoritative, without requiring thinking or analysis.

6. Developing meta-cognitive processes: During learning sessions it is useful to encourage learners to describe the thinking processes they use and to demonstrate them. It has been established that consolidated data and plans develop thinking about their thinking. The relevant language in this context includes utterances such as: “Describe the stages of the activity,” “What should be done first,” “What helps you remember these things?”

7. Analyzing the logic of language- Efficient thinking may be enhanced by implementation of lucid articulation and by the use of precise linguistic terminology related to task and process. When commenting to a learner or a colleague: “Pay attention to your calculation” – the precise meaning of the words does not match the intended meaning, namely to avoid

mistakes in the future or correct ones that exist. A better expression would be “check your work and see if you can correct it please”, or “Are you sure of the correct spelling of the word you are about to use?”, “how can one make sure?”

Methodology

1. Accumulating data: The data collected consisted of transcripts of our joint group meetings with our students following their classroom interactions. two groups of which the writer was the moderator: Group One consisted of instructors of *Inspire Academy* as part of their in-job training. Group Two – comprised of non professional adults – parents, grand parents and care givers.

2. Research tools: Since all processes and mediation share characteristics of language, it seemed appropriate to use linguistic analysis tools. The tool used in this research was analysis of verbal input. Verbalisation was used in all facets of the process. Mediating thinking skills by way of reasoning is deeply rooted in processes of verbal conceptualisation, problem-solving, self regulation, self talk, all linked to the language of thinking. Together they have constructed our community’s specific thinking jargon. All data was verbal in nature.

3. Data analysis: The analysis is restricted to discourse relating to the aims indicated above: (a) mapping and determining conceptual parameters which benefit from the change introduced into training and practice (b) Finding out **whether Early Childhood Multiple Most Inspiration** - should be adopted as a platform for training fir non professional mediators and at a younger age. (c) Revealing possible transformations this experience engenders in he professional perception of *Inspire Academy* staff.

Categories of events and all their derivatives were coded. Following Strauss and Corbin’s (1990) suggestion, an open coding, uninfluenced by research questions was undertaken. Their procedure entails breaking down and naming sentences or data facets, comparing events in order to apply a shared name to similar events, and grouping names and codes into categories of a higher level of commonality than the words themselves. The conceptual parameters revealed as the core categories for mapping were: Linguistic knowledge, Procedural knowledge and Declarative knowledge. This mapping is the subject for further investigation to be pursued using in depth disciplinary examination, and are therefore beyond the scope of this paper.

Conclusion

It should be stressed that the research is still under process and therefore all findings are relevant to the time they are written alone. The

most interesting result so far was the authentic demand stemming from Group Two to broaden this experience by mentoring to a non professional audience. Furthermore, a feeling of discomfort and doubt was professed regarding the 'correct' style of parenting. For the first time in many years of counseling partnership did fundamental issues emerge in a bottom-up process of enquiry and speculation. The main issues that stood out were: (1) The faults and merits of a challenging environment. (2) How to undertake meaningful handling of learning issues? (3) The balance between support as opposed to independence. (4) The optimal level of mediation for empowering thinking skills. (5) What to expect from professional care takers? (6) How to motivate children for success? (7) How to handle failure?

Regarding the professional staff transformation, three tendencies emerged: (a) Participants' reports indicated this praxis had fostered a holistic approach to training which promoted transferability of skills within content areas and skills. (b) Using **Early Childhood Multiple MOST Inspiration** sustained the ecological approach and enabled staff members to cater to multiple intelligences of a variety of learners. (c) Group One gained insights as to their dual consecutive role as life long learners and mentors, whereas Group Two gained priceless insights as to the need for an ongoing dialogue as part of professional development and personal enrichment.

Synergizing the expertise of **Early Childhood Multiple MOST Inspiration** moderators- experts in assessment, mediation, pedagogy, curricular planning and adjustments, both groups created a unique opportunity for an environmental parallel professional development and growth.

Preliminary findings supported the assumption that the three theoretical legs upon which the conceptual framework stands, namely MLE, LOT and MI all offer a substantial contribution to the praxis offered by **Early Childhood Multiple MOST Inspiration**. Evidence indicating the three can interact and support each other and that professional mediation employing the correct combination, timing, and orchestration initiate change and growth of all parties involved in the interactions.

At this early stage of an ongoing research it can be hoped that **Early Childhood Multiple MOST Inspiration** when fully investigated and documented may lead to a new multidisciplinary synergized theory on training and intervention portraying visual, verbal and logical literacy.

In a nutshell, **Early Childhood Multiple MOST Inspiration** proved to be a powerful and effective tool for training as well as for in-service-training. It was seen that **Early Childhood Multiple MOST Inspiration** can be used in the context of a variety of subjects It was evident that it can be applied as a consecutive process of mediation – as a BY Proxy MEDIATION process in which mediatees mediate to their respective students. **Early**

Childhood Multiple MOST Inspiration is therefore a valuable platform adaptable for developing parental counseling and after school programs . It was evident that the model carries limitations in terms of its applicability without massive supervision. It is still unclear whether **Early Childhood Multiple MOST Inspiration** can be applied in other contexts. The effect on staff burn-out is yet unclear. Given the fact that the after-action research is still in process other consequences as well as contradicting evidence may be added at a later stage.

References:

- Costa, A.L., (1991).The school as a home for the mind. Costa, A.L., *Developing minds: A Resource Book for Teaching Thinking*, Alexandria, Va., ASCD Vol. 1 pp. 47-54
- Costa, A.L., and Marzano, R., (1991). Teaching the language of thinking. Costa. A.L., (Ed.) *Developing Minds: A Resource book for Teaching Thinking*, Alexandria, VA; ASCD. Vol. 1. Pp. 251-254.
- Hadas-Lidor, N., (1999) (Hebrew text) Cognitive Dynamic Intervention and its Implications on Social and Cognitive performance of Schizophrenic Patients. *Occupational Theray Review* (Hebrew)
- Hoffman, D.M.,(1996) Cultural and Self in Multicultural Education: Reflections on discourse, text and practice. *AERA Journal*, 33:545-570
- Feuerstein R., Falik, L.H., and Feuerstein R.S., (1998). The Learning Potential Assessment Device: An alternative approach to the assessment of the learning potential. Samurda, R.J., Feuerstein R., Kaufman, A.S., Lewis, J.E., and Sternberg, R.J. (Eds.) *Advances in Cross Cultural Assessment*. Thousand Oaks, CA, Sage.
- Gardner, H., (1983) *Frames of Mind; The Theory of multiple Intelligences*. NY, Basic Books.
- Hoffman, D.M.,(1996) Culture and self in multicultural education: Reflections on discourse, text, and practice. *American Educational Research Journal*
- Kozulin, A., (1998). *Psychological tools: A Socio-cultural Approach to Education*. Cambridge, MA: Harvard University Press
- Kozulin, A., (1999). Sociocultural contexts of cognitive theory.*Human Development*. Vol. 42(2):78-82
- Laborde, G., (1984) *Influencing With Integrity*. Palo Alto, CA, Syntony Press.
- Nassie,I. (2004) A Critical Enquiry into Hebrew Spelling-Thinking Meiation, Anglia Ruskin University Doctoral Thesis
- Nassie, I.M., Shani M., and Bar-on, S.; (2008), *MOST – Model of Ongoing Supervised Training for Thinking Language*. Presentation at BERA conference 2008, Scotland

Nassie, I.M. and Shani M., (2009) *MULTIPLE MOST: Using a Model of Ongoing Supervised Training as a Platform for Merging Theory and Practice in Multiple Disciplinary Contexts*. Presentation at ICERI Conference, Madrid, Spain.

Schechter, C., Syeks, I., and Rosenfeld, I. (2004). Learning from Success: A Leverage of Transforming Schools into Learning Communities. *Planning and Changing* , 34(3-4), 154-168.

Tishman, S., Perkins, D., and Jay, E., (1995). *The thinking Classroom: Learning and Teaching in a Culture of Thinking*. Needham, MASS., Allyn and Bacon.

Vygotsky, L.S., (1962), *Thought and Language*, Cambridge, MA, MIT Press.
Wang, M.C., Haertel, G.D., & Walberg, H.J., (1990); *What Influences Learning? A Content Analysis of Review Literature*. *The Journal of Educational Research* Volume 84, Issue 1: 30-43

IMPACT OF BUSINESS ENVIRONMENT ON ORGANIZATION PERFORMANCE IN NIGERIA- A STUDY OF UNION BANK OF NIGERIA

Gloria Obiageli Eruemegbe

Head of Flexcube Functional Support, Branch Operations Coordination,
Union Bank of Nigeria Plc.

Abstract

The study seeks to unravel the factors that affect construction workers' motivation and the corresponding effect of the identified motivational factors on workers' performance and overall productivity. To answer research question and test formulated hypotheses, the study relied on questionnaire to generate relevant data out of 39 questionnaires administered on officers in Union Bank of Nigeria, Lagos, only 20 were properly completed and returned. This gave an effective response rate of 51%. The survey revealed that, among the top ten critical factors (i.e. teamwork, work based on contract, supervision based on leadership by example and provision of equipment) had great effect on motivation as well as impact on productivity. More so communication, love and belongingness, opportunity to undertake challenging task, identification with goal and overtime were among the critical factors.

Keywords; Concept of Environment, Business Environment, Organizational Performance and Effects of Business Environment on Organizational Performance

Introduction

Business is any commercial or economic activity that tends towards business profit. The primary, objective of business organizations is to make profit, grow and survive in the environment in which it operates.

The environment in which business organizations operate is a complex, multi-focus dynamic and has a far reaching effect on such organization. The environment tends, shape the outlook, and goal of the organization by placing constraints on them. These constraints in the environment of organizations goal could be in the form of competition, this sets a limit on the goals specify by the organization. For instance, trade union asking for increase in salary, will affect the shareholder dividend. Unethical

behaviour also affects profit. All these settings provide multiple contexts that influence how the organization operates and how and what it produces.

(Oghojafor, 1998)

In management, the word “Environment” does not necessarily mean physical surroundings, but is used to describe all those influences that bear upon the individual organizations. Business environment is used to mean anything, which surrounds the business organization. It affects the decisions, strategies, process and performance of the business. The environment is consisting of factors which are beyond the control of the business (STEP) social, technological, economical, legal and political. It provides opportunities or poses threats to the organization.

Since business makes demand on the society and the society makes demands on the business, managers in any organization must interact with and respond to environmental factors internal or external to their organizations. The sum of these interrelationships within the business and between the business and the society is what is the management regarded as business environment.

Organizations survival and success depend on the appropriate adoptions to a complex and over changing environment. It is pertinent for top management of organization to identify opportunities and threats in the external environment. Internal environment, it should focus on strengths and weakness, potential and existing ones. It should respond swiftly, in order to know where it can have competitive advantage over its rivals. Therefore, any organization should look or search its environment continuously. Oghojafor (1998).

The Nigerian business environment has witnessed a lot changes from the period of the oil boom in the 1960s and the early 1970s. Austerity measures in the early 1980s and the structured adjustment programme in the late 1980s from the company act of 1960s allied matter decree in the 1990s, undoubtedly brought in the eighty’s the opportunities to be exploited by some firms or the problems that inhibit the survival of so many business firm.

The need for studying business environment became important considering the fact that business organization do not operate in vacuum and effective management in complex and dynamic society such as Nigeria, requires the assessment of strengths and weaknesses of the organization and the opportunities and threats posed and the challenges of the external environment by the challenges of the external environment. For survival and growth, organization must adapt to these changes. The objective of this study is to examine the impact environmental challenges on the performance of business organization.

Objectives of the study

- i. To determine the extent at which environment factor affect Nigeria business.
- ii. To evaluate business environment in order to ascertain the type of environment suitable for growth and development
- iii. To add to existing knowledge in various categories of business sectors
- iv. To explore ways in which effective performance can be ascertained
- v. To examine the environment and business relationship.

Research questions

- i. How does an economic problem affect the business environment?
- ii. How does the improvement on technological level affect development in business environment?
- iii. How does ethnical behaviour affect the performance of employee or an organization in the environment?
- iv. To what extent will political instability affect business environment?

Concept of environment

Environment is the totality of the surroundings of the organization for wider concept. Harrison (1996) defines environment as all the conditions circumstances, and influences surrounding and affecting the development of the total organization or any of its internal systems. He argued that environment contains forces of complexity that are dynamic to varying degrees at differences, and under different circumstances.

Atsegbua (2002) described environment as the system of abiotic, biotic and interact and simultaneous to which he adapts and transforms and uses in order to satisfy his needs.

The Black Law Dictionary (6th edition) physical, economical, cultural, aesthetic and social circumstances and factors which surround and affect the desirability and value of property and which also affect the quality of peoples' lives.

In environment, the word "environment" is used to describe all those influences that bear upon the individual organization. Bernard (1999) notes that environment consists of atoms and molecules, agglomerations of things in motion, laws of men, emotions of physical laws, social laws, social ideas, norms, action, of forces and resistances. Their number is infinite and they are always changing.

The nature of the constituting the environment often confronts management with the need to make decisions under considerable uncertainty. The dynamic nature of variables that are seldom well identified their controls over the outcomes of events initiated within the organization are also complex. However, the frequent lack of control does not mean that

management should disregard the environment, but rather that it must undertake continuous surveillance of the environment so it may respond to adverse reactions or outside changes.

Every organization must exist in some extent; no organization is an island unto itself. Each organization has goals and responsibilities relates to others in its environment. Not only must or organization deal with its environment in coordinating its everybody's affairs, but it is must also give consideration to the goals of others, as it establishes its own goals and conducts its operations.

Business environment

As a concept, business environment is regarded to be a complex and important consequent, the concept has been addressed in a number of ways by different scholars. For example Ola (1993) seems to believe that business environment is phenomenon that is too complex and too varied to be captured by any one definition.

The important of business environment has been attested to by numerous scholars such as Oyebanji (1994), Lawal (1993) and Aldrich (1979). All these scholars have discussed extensively that business environment is an important process to influence on a group in particular situation to motivate others to goals achievement. Environment in management does not mean the surrounding but it covers the factors of forces that affect business effectiveness in the process of producing an intending result.

Oyebanji (1994) defined business environment as those factors that can influence the individual's business organization. He stressed further by saying that every organization must take into consideration the environmental constraints, material and human resources in their respective business in spite of their differences in status and that the effect of the environment carries from one situation to another.

Ola (1993) classified Nigerian business environment as the Nigerian economy since the businesses are established and managed within an economy. He was of the opinion that the state of affairs has a significant on the business within that economy.

Oyebanji (1994) further testified that Nigerian business environment has witnessed a total change, which started from the oil boom era in 1960s austerity measure in the early 70's and structural adjustment programme in the 80s.

Aldrich (1979) said the environment was made up of stable and unstable homogenous, heterogeneous, rich and poor, complex and simple, unpredictable variables. He further stressed that business environmental

factors change along with factors of production and environmental influences may be stable over a certain period of time.

The assertion was supported by Ashley and Van de Van (1986), which had the view that the manager's basic role is to be able to manage and control the organization in the difficult and emergency period. Changes take the form of adaptation. The manager must perceive the process and respond to a changing environment by re-arranging the internal organization structures so as to ensure survival and effectiveness. The need for studying business environment is important considering the fact that business organization do not operate in a vacuum, effective management to complex and dynamic society requires the assessment of strength and weakness of the organization and the opportunity and threat posed by the challenges of the external environment. For survival and growth, organization must adapt these changes.

Types of environment

There are two types of environment namely, External environment and internal environment (Lawal, 1993).

The Internal Environment

This includes situational factors within the organization. These factors are largely the result of decisions of the management process, most times under management control. It is described as the resources, behaviour, strengths, weaknesses, synergy and distinctive completeness within or internal to the organization.

An organization uses different types of resources produces synergy or dynergy within an organization which leads to the development of strengths of weaknesses over a period of time.

Organizational capability in the design and implementation of corporate policy and strategy rests on the organization's capacity and ability to use its distinctive competencies to excel in a particular field.

There are five major variables within the organization that management must consider:

(i) Objectives (ii) Structure (iii) Tasks (iv) Technology (v) People

Objectives

These are the specific desired results, the group wishes to attain, by working together. Management's development of objectives through the planning process is a powerful mechanism of co-ordination. It helps the members of the organization know what they are expected to accomplish. It helps the members of the organization know what they are expected to accomplish. The objectives could be in terms of increase in profit,

productivity, cost-effectiveness, market shares, quality service, and new product development, management training and selection, Social responsibility etc.

Structure

Formal organizations are made up of several levels of management and sub-units called functional areas in marketing, personnel, finance, productions etc. Structure of an organization is the logical relationship of specific management levels and functional areas arranged in such a way as to permit the effective attainment of objectives.

Tasks

Assigned work to be completed in a specified manner within a specified period of time. An outgrowth of the division of labour is the creation of tasks. Based on management's decision on structure, each position is assigned a set of tasks, intended to make a contribution to the attainment of the organization's objectives.

Technology

This is a management raw material - people, information, or physical; materials - into desirable goods and services. It also includes machines, equipment supplies of knowledge used in the transformation process.

People

When we speak of organization, management, subordinates, workers we are simply describing groups of people. When a factory close an abstract man management did not make that decision some individual did. When a company's product is of low quality, it is people who have not done their job correctly. Management attains its objectives through people-therefore, people are important and these differences must be learned. Research has shown that the probability of any two people behaving in an absolutely identical manner in all situations is nil.

Figure 1: Interrelatedness of Internal Variable of Organization

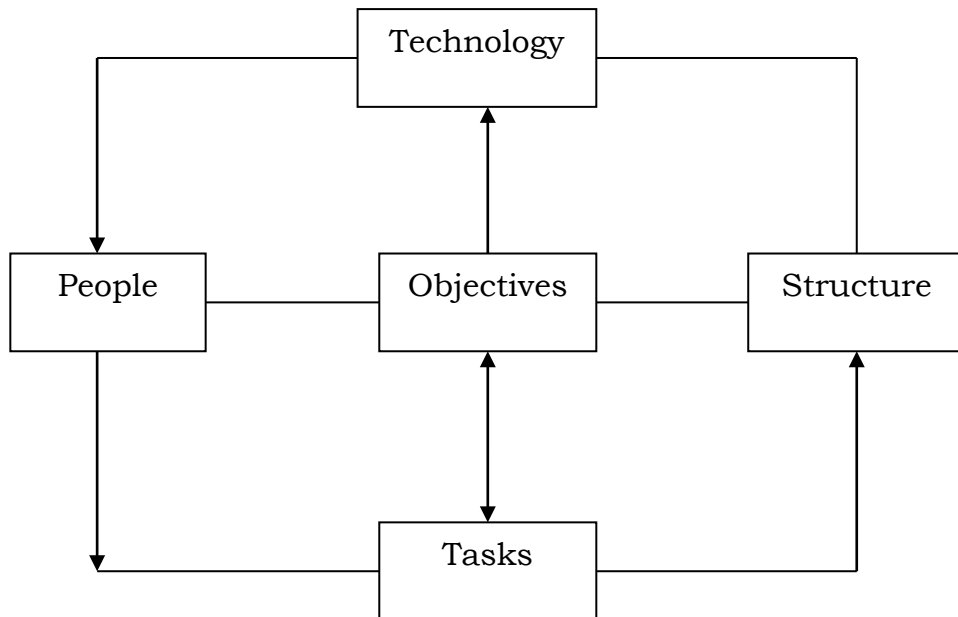

Source: Emerson, J.E (2002), Essential Management: Illinois McGraw-Hills

All of the internal variables are interrelated. A change in one variable invariably affects others to some degree. If it has a negative effect on one variable it may impede the attainment of organizational objectives.

External environment

An organization's external environment consists of those things outside an organization such as customers, competitors, government agencies, suppliers, labour, financial firms that are relevant to organization's operations.

It consists of all elements existing outside the boundary of the organization, which have the potential to affect the organization. They are relevant to organizations operation and must be carefully monitored.

Types of external environment

There are two types of external environment

Direct (task) Environment: These are factors that directly affect and are affected by the organization's operations and performance. These are: customers, competitors, labour unions, government regulatory agencies.

a. Customers: People and organizations in the environment who acquire goods or services from the organization is the organizations success. The only valid business purpose is to create customers.

b. Competitors: Other organizations in the same industry or types of business that provide goods or services to the same customers. Unique competitive issues, entry difficulty etc are key issues to be addressed here.

c. Suppliers: People and organizations who provide the raw material the organization uses to produce its output (materials, equipment, energy, and capital, labour).

d. Government Regulatory Agencies: There are several government agencies regulate the activities of business through politics and laws which have great influence on business. These laws and policies have positive or negative influence on the businesses.

Indirect (general) environment

It covers a broad dimension and influences it's surrounding which create the overall not necessarily associated with other specific. Each dimension embodies the condition and events that have the potential of influencing the organization in special ways.

(A) economic dimension

Griffin (1997), in his write-up stressed much on the overall health of the economic system in which many organizations operate.

The important economic factors, which affect many businesses, are inflation, interest rates and unemployment. In order to recover such money, companies raise price of their product and the consumer demand will fall because they will be unwilling to pay more on a product.

When there is high rate of unemployment, the company becomes selective in the recruitment of personnel and this could cause low production, which eventually makes the company to lose its customer's demand.

(B) technological dimension

It refers to the method of converting resources into finished products and services by using new machines. The technology, which is applied within an organization, comes from general environment. It includes inventions and improvement of existing methods, machines and materials.

This could mean the vast storage of organized knowledge of doing things mechanically rather than manual. The result of technological influence is on the methods of work, design of production as well as machine and improved services.

The benefit to the society can be itemized as follows:

- i. Increased in the availability of goods and services to the society.
- ii. Reduction in price, though it encourages large scales production and improves the standard of living of the society
- iii. Efficiency of production is maintained

iv. It improves the design, planning, scheduling and control of production system.

v. Mechanization and automation of the organization system are made possible. Mechanization is said to be substitution of machinery, which is for labour. Capital-intensive equipment while automation is the manufacturing of product or its parts automatically from one process to another.

(C) ethnical/social dimension

This includes the customers, moral values, rules and demographically characteristics of the society in which the organization function. Ethnical behaviour process is important because it determine the product, services and the level of conduct that the society is likely to get. It allows for a cordial relationship between management, workers and their customers.

Oyebanji (1994) said that behaviour are interwoven with each other and it is difficult to distinguish individuals and their behaviour, that the attitude of individuals differs in work habit, risk taking, introducing or accepting challenges, assess the level of authority, material again. Ethnical heritage manifest itself in certain behavioural patterns being observed in business operation.

(D) political dimension

It is observed that political factors are the government regulations on business. The relationship between business and government are important for three basic reasons.

First, the legal system partially defined what an organization should or should not do.

Secondly, the pro-business or anti-business sentiments, in which the government use to influence business activities in organization.

Thirdly, the political stability has ramification on planning, for example, no organization wants to set up business in another country where the trade relationship are not relatively defined and stable.

Oyebanji (1994) believed that a stable political environment enhance growth and development and also encourages both foreign and local investors. As regards to legal environment, it encourages the business organization to stay abreast to any business legislation. For business organization to be legally fit, the big ones need to establish the legal departments while the small ones hire the service of legal experts. In Nigeria, the present political dispensation does not encourage investors both foreign and local.

(E) government

Government passes regulations on industries, this has considerable effect and impacts on business the regulatory being set up by government to prevent the public from certain business practice for example the FEPA, NAFDAC and NDLEA.

Organizational performance

Organizational performance involves the using of resources wisely to avoid wastage. Given by the interaction between organizations and environment, it follows that performance relates to how an organization reacts, understands and influence to certain environment changes. Unfortunately, people do not want to perform those duties without a concession. For example they can perform their duties in short time if well planned.

Through firm money intending to take unnecessary action and decision such as embarking on research and development, which may displease the investors who have a short time to stay.

Okunola (1998) described organization as an entity formed by or comprising a group of people with the aims and objective carrying out some specific functions or performance of responsibilities or the other.

Derek (1998) defined performance as the willingness of an individual to carry out the goals and objectives of an organization.

Organization performances is however, defined as a group of people that come together and are willing to carry out goals and objective and planned or strategize. Organization performance is the ability of group of individual to achieve certain of specific goals.

Effects of business environment on organizational performance

The business environment and its application to work environment is an outcome of his work as director of the institute of social research, university of Michigan, USA. In his book “New Pattern of Management” about high producing supervisors who achieve the highest level of productivity at the lowest production costs with the highest level of employee motivation. In his research work, he indicates that high producing managers tend to build their successful achievement around their interlocking work groups employees whose level of co-operation is sustained through range of business incentive that extend motives and involves the ego and creativity motives. The research noted that the high producing manager utilized the tool of the classical management work-study while recognizing the aspirations of the employees by encouraging participative approaches. Okunola stressed the important of supportive relationship; management can thus achieve very high productive performance when the employees see their

membership of the work group as “Supportive”, that is, when the experience a sense of personal worth, importance and recognition from belonging to the work group.

Okunola (1998) is an e management philosopher who focused on the differences between individuals and the class of needs in addition to the market strategy, which include the need for achievement, power and for affiliation.

He further related the strength and/or dominance of each need in individual with high need for achievement strive on jobs projects that tax their won skills and abilities. They also set realistic goals and objective for them, such people are usually individualistic and would want to be appraised as to how well they are. However, the greatest disadvantage for those with achievement need is that they tend to be more task-oriented and less concerned with strong power needs to dominate or gain power influence of control over people. That the motivation managers and supervisors to possess some reasonable degree of all three kinds of needs.

However, the dominant need, according to Okunola’s findings, is the need for achievement. Nevertheless, his ideas are very important as a contribution to our understanding of business environment how best the concept of achievement need might be applied in practice at the work place, and especially when dealing with young, ambitious employees.

Business environment is formed not merely on some sense of objective reality, but on its own perception of reality, business needs to properly taken care of, for profit margin to be accurate. In consonance with this theory, individuals attempt to determine the probability of a measure of expectancy of outcome. The personal outcomes are rewards that organization can provide like pay increase, promotion, bonus, allowances, level and even relationship with workmates etc, while the expected to such outcomes refers to expectancy, the measure of importance attached to such outcomes or reward is known as valence, the value of which are a result of the attractiveness and the opinion of the beneficiaries about the reward in questions.

In order to improve business environment therefore, managers should improve the skill and motivational level or conditions of the employee. In establishment where promotion is perceived as attractive prospect (valance) by a newly appointed staff, it allows the effective performance of works, it encourages the perception of the workers, which they have toward their job, on ‘god fatherism’, and his output is discouraged. All efforts directed towards performance do not necessarily lead to reward but it’s been ascertain that reward increase the effective performance of employees.

The exhibition of negative business environment understanding of course proves to the management the need to control environmental factors

by the creation of certain adequate adjustment and motivational incentives. Lack of free environment problems among workers, employers and customers in the organization allow frustration and negative uncompromising behaviour which are exhibited as apathy, increased absenteeism, planning and execution of fraudulent acts etc. they become disgruntled, pessimistic, counter-productive and develop defensive mechanisms. In effect, workers indulge in acts and practices that jeopardize and negate the attainment of organizational goals.

The managers should work out the appropriate plans that would enable the workers to be highly task-oriented towards the fulfillment of the organizations ultimate goal in his bid to reach personal goals and achieve them. It is here that the worker intensifies goals-oriented action in his pursuits of both company incentives and personal goals.

At the attainment of his final goals, the previously aroused tension reduces and fails completely. Thus, a continuous exhibition of the same incentive package may fail to elicit further favourable and positive behaviour from the same person. There the manager's job is more demanding as he is expected to know the proper solution to the situation he might be in the process of achieving the ultimate goals of the organization.

The implication to management in nigeria

It is clearly stated that in an environment, certain opportunities or threats may be minimized by the organizations on those activities which are either profitable or a threat to the business organization. The practical example was during the oil boom era in the late 70s and early 80s in Nigeria whereby the oil sector of economy accounted for about 22% of the Gross Domestic Product out of 80% of the total government revenue and over 90% of the export earnings. At the time, the organizations were flourishing until the sudden fall of the oil price in the mid 1981.

However, foreign exchange crises emerged and there was a decline in the price of US dollar, which fell from \$25.9 billion in 1980 to \$7.2 billion in 1986, which had adverse consequences of the company under study.

Since then, many business organizations have been finding it difficult to survive. They could no longer produce quality product; hence the masses preferred foreign products due to the following reasons.

Economic factors

There is quality in the foreign product, price reduction and availability of the product in the market.

Psychological factors

People seek for distinctiveness, exclusiveness and egoism in the quantity of most goods and it is only foreign products that probably have that outstanding quality which most buyers and owners of goods are looking for.

Historical factors

Habits and past experiences can influence the consumers taste and choice, for example, even before independence, Nigerians preferred foreign products to local ones, and this has come to stay in their behaviours.

Government attitude and regard to foreign goods

The government preferred and placed much regard on foreign contractors to the local ones; they also allow foreign products to be imported into the country at low rate of import duties and by its weak attempt to check smuggling.

In conclusion, for many business organizations to succeed in his turbulent time, it has to be managed very well so as to withstand sudden fall and to avail itself of sudden unexpected opportunities.

Research methodology

This study utilized both primary and secondary sources of data collection for the collection relevant information needed in the study. The primary source includes questionnaire and personal interview with the respondents to collect information for the study. The secondary sources include journals, articles, magazines, textbooks and literature review and shall serve as basis of our theoretical framework.

The method of data analysis and test of operational hypothesis is non-parametric technique which utilize chi-square statistic.

The research design is the framework analysis and interpreting the research observation. In actual fact, it reveals inferences concerning casual relation and defines the domain of generalizability. Basically, the survey method is utilized as the basic approach of the study. The method attempts to be fairly representative of the population of interest in its selection sample of study. Questionnaire, structured interview and secondary data are the tools that will be used as descriptive survey to obtain desired information. Osuagwu, L. (2002).

Population of the study

The population of this research study is the entire employees of Union Bank of Nigeria. The population of the study was two hundred and fifty (250) and seventy (62) was administered. However, because of the large number of beverage companies in Lagos and the time framework within

which this study is expected to be completed, a beverage company is selected as a case study.

Sample and sampling technique

Union Bank of Nigeria is chosen as the representative of the population. For this study, a sample size of 62 respondents was sampled. The 62 respondents were taken randomly on equal basis from the related departments of the bank.

Sources of data

The data employed in compiling this research study are obtained from primary and secondary sources. The primary sources of data collection give the researcher information directly from the subject being selected. The primary sources of data will be through questionnaire and observation. The secondary source of data is data derive internally base on desk research.

Data analysis and interpretation of results

The focus of this chapter is mainly on the analysis of facts gathered by the research through the administration of questionnaires. The questionnaires which are mainly administered to Union Bank of Nigeria employees and management staffs was used to gather data in form of getting the opinions of these respondents on the impact of business environment on organizational performance.

The hypotheses formulated and stated will then be subjected to test in order to discussion. This is through the use of scientific analytical tool. The research is also aimed at towards finding out whether or not business or workplace environment has contributed to the performance or not.

Summary

The business environment are those factors that influences the individual's business organization historical factors, psychological factors, government attitude and regard to foreign good, international factors and marketing approaches. The relationship between business and its environment is mutual, that is, the environment exerts pressure on business, while business, in turn influences various aspects of its environment. Business also depends on its environment for the supply of all its inputs and at the same time to absorb its output.

The influence of the environment boils down to two essential forces which the organization must respond to – information gathering and scarce material and financial resources. These forces create uncertainty i.e. lack of information to anticipate external changes and resources availability.

There are two categories of environmental forces that influenced business performance. These are internal environmental forces and external environmental forces. The internal environmental forces or influence are those that affect the enterprise as separate entity. They consist of function structure and relationship in the enterprise. The forces that affect a business unit as well as other enterprises operating within the same environmental are known as external environment. They are external to the enterprise and cannot be effectively controlled by managers. They are relevant for the success of the organization.

The business enterprises in Nigeria have several limitations that account for their inefficiencies and failures sometimes. Many of these problems are unique to small enterprises, while others are general to all business enterprises irrespective of size. The internal problems that affect the small scale enterprise and other enterprises in general include among others; wrong choice of business, lack of export, lack of business connections, management incompetence, lack of adequate attention, marketing problem, unethical, location problem, absence of production improvement technique, etc.

In order to determine the impact of business environment on the performance of organization, questionnaires were distributed to staffs and employees of Union Bank of Nigeria in order to elicit information about environmental forces that influence their company's performance.

Recommendations

In order to reduce uncertainty in the environment, the following recommendations are therefore suggested:-

1. The company should improve on their motivational level, since it is obvious that rewards tends to increase the performance of workers. The management should try to make their workers comfortable.

2. Manager should be properly trained, so as to enable good supervision of their employee's job. The manager tends to have the ability to control, plan and organize his or her company, when they are well trained for the task.

3. The management should remember to give benefits to workers who are entitled to it; it will encourage the workers to take their job as important as possible. The management should also decentralize power or authority; they should learn to listen to workers opinion because it allows for cordial relationship.

4. Finally, the organization should learn to consider government policies or regulations. This will help to build the business since profit margin of the company will not be hindered by the regulation.

Conclusion

This study focus on the impact of business environment on organizational performance, it is important for the management to check the relationship between the workers; employees and their customers.

In the absences of good infrastructures, the productivity level could be affected and it may also hinder the performance of the workers. There is need for motivation on the part of employees. However, it is necessary to consider the effect of the research on Union Bank of Nigeria as the sample or case study. The conclusion gathered from the study is that:

1. Environmental factors, which are the basic problems which business faces, should be well tacked. It will help to build the relationship between the management, workers and customers.

2. From the analysis made in the study, it will be suitable to improve on management level, worker welfare, consider government policies, well trained or educated and finally improve on the technological equipment used for business.

3. This research will help in adding to knowledge of people in business. People could use some analysis/techniques in the research to solve certain problems they might face in their business.

4. Knowing that business effectiveness cannot be ascertain, the research will help the company to ascertain or achieve effective performance, through the use of some of the techniques.

5. The research has shown that there is a relationship between business and environment.

References:

- Aldrich, H. (1979). *Fundamental as Moderate of Job Satisfaction*, New York; Random House Incorporation.
- Aguilar and Osaze (1991). "Nigeria Corporate Policy and Strategic Management", C.M.D., Lagos, Nigeria.
- Ashley & Van de Van (1996). *Test of Economics Fundamental Management Journal*, ELBS and MacDonald & Evans Limited, London & Plymouth.
- Atsegbua, K. (2002). *Changing Organization: Essays on the Development and Evolution of Human Organization*, New York: McGraw-Hill Company.
- Bernard, I.C. (1999). *The Functions of the Executive*, Cambridge, Mass: Harvard University Press.
- Boone, L.E., and Kurte, D.L. (1987). *Management in Focus*; New York, Random House Incorporation.
- Derek, B. (1998). *The Changing Environment of Business*, 2nd Edition: Boston; Kent Publishing Company.
- Emerson, J.E. (2002) *Essential Management: Illinois*; McGraw- Hills.

- Griffin (1997). “Business Today”. *Management Journal*: Random House Incorporation.
- Harrison, F. (1996). *Policy, Strategic and Managerial Action*, Boston; Houghton Mifflin.
- Henry, H.A. (1974). *Principles of Modern Management* :(4th Edition). John Wiley and Sons, New York.
- Isimoya, S.A. (1998). *Nigeria Business Environment*, Abiola Bookshop Press Ltd, Ikeja, Lagos.
- Kareem, Y. (1998). “The Changing Organization Behaviour Patterns; Boston: Harvard University Press.
- Lawal, A.A. (2000). “Management in Focus”, Lagos: Malthouse Press (2nd Edition) Revised.
- Mohamed, A.S. (1997). *Management at Glance*, Vol. II, Kola Saliu Press Nigeria.
- Oghojafor, A.B. (1998). *Strategic Planning a Guide in Nigeria*: Malthouse Press.
- Ojikutu, R.K. (1995). *Statistics for Undergraduate*, UNILAG: Campus Press
- Okunola, J. (1998). “Management of Business Organization in Nigeria: Olaide Commercial Press.
- Ola, C. (1993). *Nigerian Business Environment*: Lagos; Published by Abiola Bookshop Limited.
- Osuagwu, L. (2002). *Business Research Methods*: Principle and Practice. Lagos: Grey Resources Limited.
- Oyebanji, J. (1994). *Nigerian Business Environment and Organization Effectiveness*; Abiola Bookshop Limited.
- Peter, L. (1993). *Organizational Management*: McGraw-Hill Book Company Limited. Singapore.
- Shartz, O. (1997). *Fundamental Management*: Irvin Publishing Company, Boston.
- Ubeku, A. (1999). *Economic Growth & Monetary Stability in Nigeria*: Published by C.M.S Bookshop.
- Yalokun, J. (1998). *Fundamental Management and Practice*: University of Lagos press, Lagos.

MARGIN SQUEEZE IN THE U.S. AND THE EU: WHY THEY DIFFER?

Professor Demetrius Yannelis

Department of Economics, University of Piraeus

Abstract

Margin squeeze has recently emerged as an important issue in the electronic communications markets in the EU, as many incumbent operators have exercised this strategy in order to foreclose competitive new entrants. The experience in all European cases considered in the literature so far shows the difficulty and complexity faced by the competition enforcement authorities in implementing the appropriate imputation test for the purpose of substantiating an abuse of the dominant position. In the US, some Courts have followed a different approach and some authors do not consider margin squeeze as a stand-alone form of anti-competitive conduct. Recent Court decisions have validated these claims and there is a renewed interest on the question of the usefulness of margin squeeze tests in protecting competition and consumers. In the economic literature, there are two imputation tests that can be applied to demonstrate an abusive margin squeeze. The first test known as the Equally Efficient Operator (EEO) test is based on the costs of the incumbent. The second test known as the Reasonably Efficient Operator (REO) test is based on the costs of the entrant. The aim of the present paper is to analyze these tests and stress their weaknesses as policy tools. In doing so we will compare the different approaches on the issue of margin squeeze by the EU and the US antitrust authorities. Furthermore, we will offer some thoughts on how the margin squeeze problem can be tackled from a dynamic point of view.

Keywords: Margin squeeze, regulation, abuse of dominance, antitrust

Introduction

Margin or price squeeze and its conformity with Article 102 TFEU has recently emerged as an important issue in the electronic communications markets in the EU, as many incumbent operators have exercised this strategy in order to foreclose competitive new entrants. The experience in all European cases considered in the literature so far shows the difficulty and complexity faced by the competition enforcement authorities in

implementing the imputation test for the purpose of substantiating an abuse of the dominant position. In the US, some Courts have followed a different approach and some authors do not consider margin squeeze as a stand-alone form of anti-competitive conduct. This approach will be examined later in the paper.

In the economic literature, there are two imputation tests that can be applied to demonstrate an abusive margin squeeze. The first test known as the Equally Efficient Operator (EEO) test is based on the costs of the incumbent. The second test known as the Reasonably Efficient Operator (REO) test is based on the costs of the entrant.

The aim of the present paper is to analyze these tests and stress their weaknesses as policy tools. In doing so we will compare the different approaches on the issue of margin squeeze by the EU and the US antitrust authorities. Furthermore, we will offer some thoughts on how the margin squeeze problem can be tackled from a dynamic point of view.

What is a margin squeeze?

In general, a margin squeeze exists when a dominant vertically integrated operator sets its wholesale and/or retail prices at levels that do not give a reasonable margin to its downstream competitors (see Crocioni and Veljanovski (2003). According to the

European Commission "Notice": "A price squeeze exists if "the dominant company's own downstream operations could not trade profitably on the basis of the upstream price charged to its competitors by the upstream operating arm of the dominant company"(see European Commission (2002b). The crucial factor is the margin between the wholesale and retail price and not the absolute value of each one price.

Below are some definitions of margin squeeze that the European Commission has applied in recent cases.

According to the European Commission Decision (2003b) in the Deutsche Telecom case: "a margin squeeze exists if the charges to be paid to DT for wholesale access... are so expensive that competitors are forced to charge their end users prices higher than the prices DT charges its own end users for similar services. If wholesale charges are higher than retail charges, DT's competitors, even if they are at least as efficient as DT, can never make a profit...". Also according to the CFI (2008) in the same case: "If the applicant's retail prices are lower than its wholesale charges, or if the spread between the applicant's wholesale and retail charges is insufficient to enable an equally efficient operator to cover its product-specific costs of supplying retail access services, a potential competitor who is just as efficient as the applicant would not be able to enter the retail access services market without suffering losses".

A similar approach has been taken by the Commission in the Telefonica case: "... a margin squeeze is an insufficient margin between the price of an upstream product A and a price of a downstream product A+B of which A is a component...It is this difference and not the specific level of the retail and/or wholesale prices which is of importance in margin squeeze cases"(see Commission Decision (2007)).

Here arises the crucial question. What insufficient means? If we adopt the definition provided by Carlton (2008) then an entrant will exit the downstream market as it will be not be able to compete profitably: "A price squeeze occurs when a vertically integrated firm supplies an input to its downstream competitors at a price that generates a profit margin so low that the competitors exit the downstream market."

However, there remains the issue of timing. Given a margin squeeze, will the entrant continue operating with a loss and for how long? Or will the entrant exit the market once margin squeeze is applied by the incumbent? These questions are important since they are related to the opening of the downstream market to competitors and to whether the NCA should intervene promptly to allegations of margin squeeze or wait until the market matures as we will see below. Furthermore, as Sidak (2008) points out "...attempting to implement regulatory policy through section 2 of the Sherman Act is ill-advised, both because it makes no sense for courts to re-regulate deregulated or lightly regulated industries, and because courts lack the institutional competence to implement regulation". On the other hand a crucial question arises: what should be the remedy? How the regulator should set the "sufficient" margin?

Recent margin squeeze cases in Telecommunications

In 2003 Telecom Italia, the incumbent telecom operator, abused its dominant position in the market of fixed line telecom services. The practices involved a price squeeze in the procurement for the provision of telecom services to the Public Administration and the use of restrictive vertical contracts with the top business clients. The wholesale interconnection services were regulated, while retail prices to the Public Administration were unregulated and were determined through a procurement auction. Telecom Italia accused for bidding below costs (see Polo (2007)).

The European Commission found that between September 2001 and December 2006, the margin between Telefonica's retail prices and the prices for wholesale broadband access at the regional and national level was insufficient to cover the costs of an operator as efficient as Telefonica (see European Commission (2007)). Furthermore, according to the European Commission, Deutsche Telekom from 1998 to 2001 has infringed Article 82 EC by operating abusive pricing in the market for direct access to its fixed

telephone network in the form of a margin squeeze. DT was charging its competitors prices for regulated wholesale access that were higher than its prices for retail access to the local network (see European Commission (2003) and CFI (2008)).

Wanadoo Interactive has been fined for predatory pricing. France Telecom's Internet access subsidiary, Wanadoo, had charged predatory prices for its consumer broadband internet access services. The company was not vertically integrated so the case was one of predation instead of a margin squeeze (see Commission Decision (2003a)).

Is there an efficient rule for pricing the input?

The efficient component pricing rule (ECPR) has been proposed by Baumol (Baumol and Sidak, (1994); Willig, (1979)) as the proper way to assign access charges to an entrant wishing to join a network which is operated by an incumbent monopoly. When the services offered by the potential entrant are substitutes to the ones offered by the monopoly, the ECPR states that the access price that must be charged by the monopoly must be equal to the average incremental cost incurred by the entrant plus the opportunity cost or profit foregone with the entry of the competitor.

Laffont and Tirole (1994) have analyzed the conditions under which the ECPR attains productive efficiency and notice that they are quite restrictive. Armstrong, Doyle, and Vickers (1996) have also examined the optimality properties of the ECPR, and their main conclusion is that since the notion of the opportunity cost is vague and very hard to estimate, the simple ECPR does not offer any advantage over the complex Ramsey pricing rule. The ECPR can be derived under the assumption that the monopoly is willing to provide entry to the competitor as long as its profits will remain the same (the “indifference principle”). However, the monopoly may not know in advance how the entry of the competitor is going to affect its profits, especially if the services offered by the entrant are not perfect substitutes to the ones offered by the monopoly. Therefore, opportunity costs may not be known in advance.

The fact is that this rule is only a partial one and has nothing to say in an unregulated environment. In the absence of regulation, the incumbent can invite entry and keep increasing the price of the wholesale input together with the retail price in the downstream market at the expense of consumers.

Margin squeeze in practice

It is well known (see ERG (2009)) that there are two imputation tests that can be applied to test for a margin squeeze. The first test known as the Equally Efficient Operator (EEO) test is based on the costs of the incumbent: If $P - c \geq d_i$ then there is no margin squeeze, where c = wholesale price of

essential input, P = downstream retail price of incumbent and d_i = downstream costs of incumbent. The second test known as the Reasonably Efficient Operator (REO) test is based on the costs of the entrant: If $P - c \geq d_e$, then there is no margin squeeze where c = wholesale price of essential input, P = downstream retail price of incumbent and d_e = downstream costs of entrant. In almost all recent cases regarding margin squeeze abuse the first test has been used. It is known that (see ERG (2009)) the second test is used in mature markets where the aim of the regulator is to promote competition.

However, there are certain limitations to the REO approach: 1) It does not provide a clear way of calculating the downstream costs of a hypothetical "reasonably efficient" entrant. 2) It may attract a non-efficient entrant and may provide proof of margin squeeze when the non-efficient entrant has very high costs. 3) It is inconsistent with the first test, which in fact has always been used by the European Commission and the Community Courts. 4) It does not assist in cases where the incumbent operator is more efficient than the entrants or some of the entrants are more efficient than others. 5) It is in contrast with the rule of competition law. Margin squeeze is based on ex ante assumptions and forecasts rather than on ex post facts.

More importantly it contradicts the fundamental assumption of economic theory that each firm sets its prices so as to maximize its *own* profits or minimize its *own* costs. Furthermore, objections to the use of the REO test are related to the question whether the market under consideration is mature or rather at the stage of commercial and technical experimentation. It is suggested that the REO test is used a) in mature markets and b) where the aim of the regulator is to promote competition. Otherwise, it is very difficult to know whether the 'hypothetical' reasonably efficient competitor is as-efficient-as the incumbent, and in any case it is not appropriate to induce less efficient entry if there are no structural deficiencies in the market.

Limitations also apply to the EEO test. At the core of all the criticisms lies a realization that the construing elements of the margin squeeze test under competition law depend on a number of *ad hoc* assumptions. The timeframe in estimating the cash flow analysis is important since it considerably affects the Net Present Value (NPV) under the price squeeze test. The range of timeframe considered in international practice is striking ranging from five to ten years. This considerably affects the value of the NPV and, therefore, the validity of the margin squeeze test. Another important factor is the type of costs and revenues included in the test. When a company enters a new market, it normally incurs significant early on-going costs, which may be reduced in the future once the company becomes more established. These higher early costs include marketing costs, advertising costs and early learning costs, as the company acquires greater knowledge of customer demands etc. The company's costs are also likely to fall as it

increases output towards an efficient scale. It is therefore, very hard for a new entrant to compete the incumbent that fully exploits the benefits of economies of scale and scope.

In any case, the courts must heavily rely their decisions on ex ante calculations based on assumptions that may prove irrelevant or simply false.

The US approach

The US approach is different than the EU approach as the margin squeeze cannot be recognized as a stand-alone violation of antitrust law. Two important cases by Trinko and linkLine suffice to show the differences in the two approaches. In Trinko the Supreme Court led to the following statements: 1) the existence of a regulation does not create an antitrust duty to deal, which was the case of the then incumbent regulated carrier Verizon. 2) if a firm has no duty to deal with its competitors at wholesale, it has no duty to deal under conditions that the rivals find advantageous. The Supreme Court in the linkLine case applied the reasoning in Trinko to pricing conditions (rather than service assistance) to conclude that if there is no antitrust duty to deal at the wholesale level and no predatory pricing at the retail level, then a firm is not required to price both upstream and retail services in a manner that preserves its rival's profit margin. The Court found that in order to establish harm from the margin squeeze accusation, it must be shown that the incumbent's retail price was predatory. Sidak and Bork intervening as Amici Curiae in linkLine case stressed the regulatory nature of the price squeeze issue, "which makes sense only as a rule of price regulation in an industry already subject to duties to deal and to control by institutionally competent regulators. Attempting to implement regulatory policy through Section 2 of the Sherman Act is ill advised, both because it makes no sense for courts to re-regulate deregulated industries, and because courts lack the institutional competence to implement regulation".

However, the two approaches may be reconciled if we can show that margin squeeze and predatory pricing constitute the same abuse. In our notation margin squeeze according to the equally efficient operator test occurs when $P - c < d_i$. Predation would imply that the retail price P is lower than the average cost of producing in the downstream market $P < c + d_i$. This may be the reason that US courts refuse to see the margin squeeze itself as a breach to antitrust law. In effect, the EU approach cares about the gap between P and c whereas the US does not pay any attention to the gap and considers these two variables as independent. The US approach is valid if one ignores the opportunity cost in the measurement of costs. Therefore, if the ECPR pricing is applied, so that the opportunity cost is covered by the entrant, then the US approach on predation is no different than margin squeeze. In this case the Chicago School of one monopoly profit is valid.

Conclusion

In this paper we tried to pinpoint the differences in the treatment of margin squeeze as a stand-alone abuse in the EU against the US. In effect, the EU approach cares about the gap between P and c whereas the US does not pay any attention to the gap and considers these two variables as independent. The US approach is valid if one ignores the opportunity cost in the measurement of costs. Therefore, if the ECPR pricing is applied, so that the opportunity cost is covered by the entrant, then the US approach on predation is no different than margin squeeze. In this case the Chicago School of one monopoly profit is valid. All profit forgone (the opportunity cost) is covered through the increase in the access price, so that the incumbent has no incentive to engage in excessive pricing in the downstream market. The profit of the incumbent remains the same before and after entry of the competitor. The US reasoning is simple: if the regulator supports fair access to all players, then the only abuse by the incumbent should be that of predation. Note that excessive price is not considered an abuse in the US so that a high enough access price would not be considered as an abuse.

In other words the difference between the EU and US approach is about how they perceive the “public” network of the incumbent. If it is the result of public investment over the years, it should be provided at cost and predation is the only abuse of dominance.

References:

- Armstrong, Mark, Christopher Doyle, and John Vickers (1996), “The access pricing problem: a synthesis,” *The Journal of Industrial Economics*, 131-150.
- Baumol, W.J. and Sidak, J.G. (1994), *Toward Competition in Local Telephony*; Cambridge, Mass: MIT Press.
- Crocioni, P. & C. Veljanovski, (2003) “Price Squeezes, Foreclosure and Competition Law: Principles and Guidelines”, *Journal of Network Industries* 4: 29-60.
- European Commission (2002b), “Notice on the application of the competition rules to access agreements in the telecommunications sector”, 1998/C 265/02.
- Commission Decision (2003b), COMP/37.451- Deutsche Telecom AG.
- Commission Decision (2007), COMP/38.784- Telefónica
- Carlton, D. (2008), “Should “price squeeze” be a recognized form of anticompetitive conduct?” *Journal of Competition Law and Economics*, 4: 271-78.
- ERG (2009), “Report on the Discussion on the application of margin squeeze tests to bundles”, mimeo.

- Laffont, Jean-Jacques; Tirole, Jean. "Access Pricing and Competition," *European Economic Review*, 38, 1994, pp. 1673-1710.
- Polo, D. (2007), "Price Squeeze: Lessons from the Telecom Italia Case", *Journal of Competition Law & Economics*, 3:453- 470.
- Sidak, G. J. (2008) "Abolishing the price squeeze as a theory of antitrust liability", *Journal of Competition Law and Economics*, 4: 279-309.
- Willig, Robert (1979), "The theory of network access pricing". In Trebbing, H.M. (Ed), *Issues in Public Utility Regulation*.